

# **bcal status:**

mechanical, beam tests,  
cosmics & simulations

---

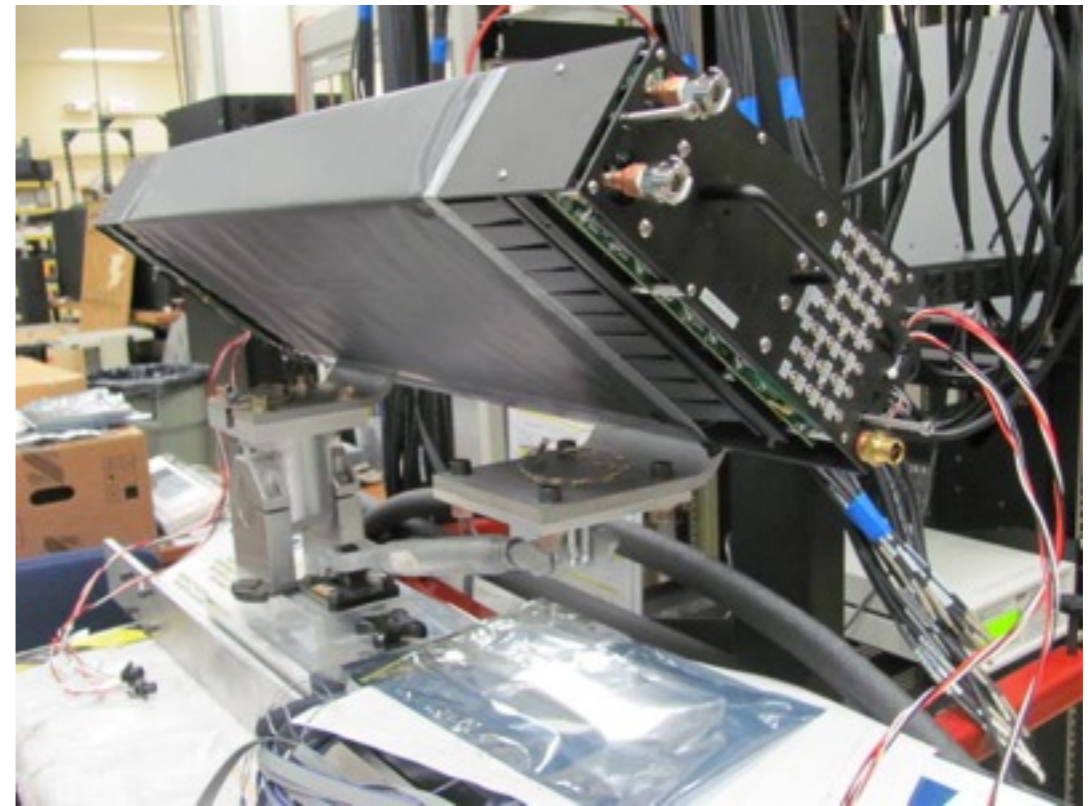

[Z. Papandreou](#)

on behalf of the BCAL Working Group

contributors:

F. Barbosa, T. Beattie, A. Fischer, S. Krueger, D. Lawrence, Y. Qiang, A. Semenov,  
I. Semenova, E. Smith, I. Tolstukhin, T. Whitlatch, *et al.*

*presented at the GlueX Collaboration Meeting, held at Jefferson Lab  
october 5, 2012*

# At a glance... work at JLab and Regina

---

- Mechanical
- Beam Tests
- Cosmics
- SiPMs
  - Readout Assembly (Integrated Electronics Wedge)
  - Resolution
  - Cross Talk and After Pulsing
  - QA & Light guides: see talk by Hayk Hakobyan
- Simulations/Reconstruction

# Module Stacking (T. Beattie, T. Whitlatch) **GlueX-doc-2036**

- In July, the optimal module stacking was looked into, based on the tolerance info on the Ross Machine Shop travellers.
- We came up with a stacking solution, accounting for the lead-off module, DC rails, and keystone.
- LG gluing starts in December.
- Modules can be stacked from bottom on the tool, until 1/2 full, craned to the platform and then inserted one by one; this depends on the work flow.

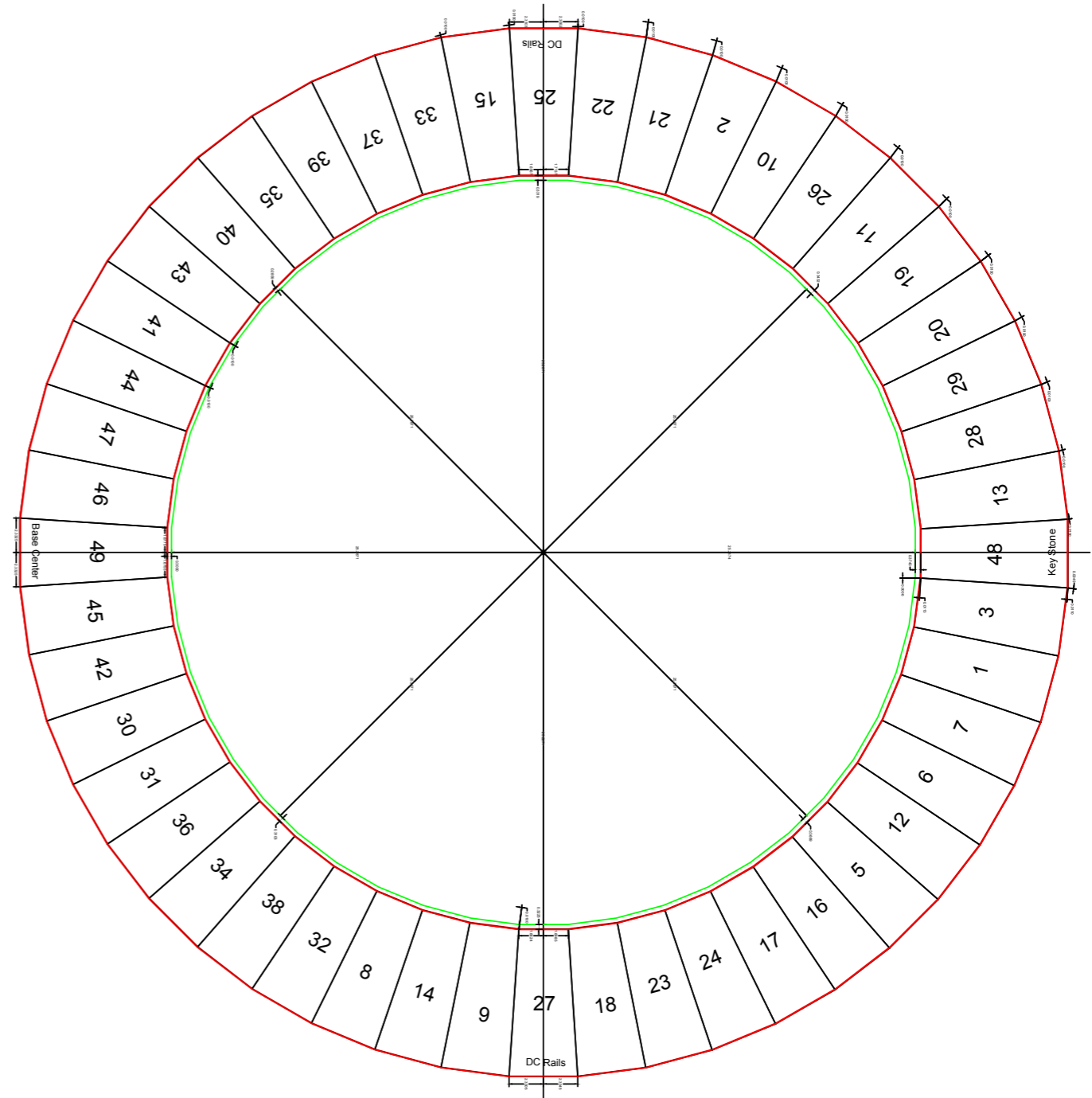

# SiPM Binning (S. Kruger, J. McKisson)

- All available SiPMs were sorted based on operating voltage, adjusted to 5°C.
- The exact resistance needed is found by  $R=V/I$  where

$$I_0 = \frac{-TCV_{desired}}{\left[ \frac{B_0 R_{T_0}^2 U}{T^2 [R_{Lin} + U]^2} - \frac{B_0 R_{Lin} U}{T^2 [R_{Lin} + U]} \right]} \quad \text{and} \quad U = R_{T_0} e^{B_0 \left( \frac{1}{T} - \frac{1}{T_0} \right)}$$

- The fixed resistance value is subtracted from the exact resistance to find the resistance that must be supplied by the trims

| Serial No. | Vop Average | Mvari  | Dark Average | Vop5C   | R2exact [ohms] | R2trim [ohms] |
|------------|-------------|--------|--------------|---------|----------------|---------------|
| 840        | 72.106875   | 11.57% | 1.1875       | 71.2869 | 92913.56709    | 123.5670881   |
| 1292       | 72.106875   | 7.29%  | 0.95125      | 71.2869 | 92913.56709    | 123.5670881   |
| 663        | 72.108125   | 8.00%  | 1.0125       | 71.2881 | 92915.19631    | 125.1963075   |

- One of the R2 trim resistors is a large resistor used to supplement the fixed resistor to allow for better granularity on the remaining resistors
- The max value of R2trim is divided such that each of the remaining 3 resistors provides (1/4), (1/8), and (1/16) of the remaining resistance needed.
- Required voltage is determined given the resistors used for the trim
- Each group will be supplied by the largest required voltage within that group
- In order to compensate for the excess voltage the Rs trim will be used.

## Objective

Select SiPMs (bias grouping and per readout module)

- A minimizing sequence is applied using various values for Rs trims until the difference between supplied voltage and ideal voltage is minimized for the entire set.
- With the evolution of the control boards these procedures will also change.



# Beam Test **Proposal: GlueX-doc-1900**

- April-May 2012 in Hall B; Group effort, thanks to Hall B!
- 80 SiPMs plus electronics, LGs, cooling; first full operational test.
- Energies, angles.
- Revealed “issues”, now addressed.

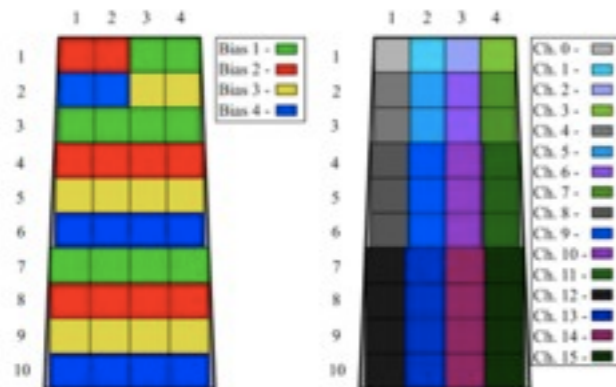
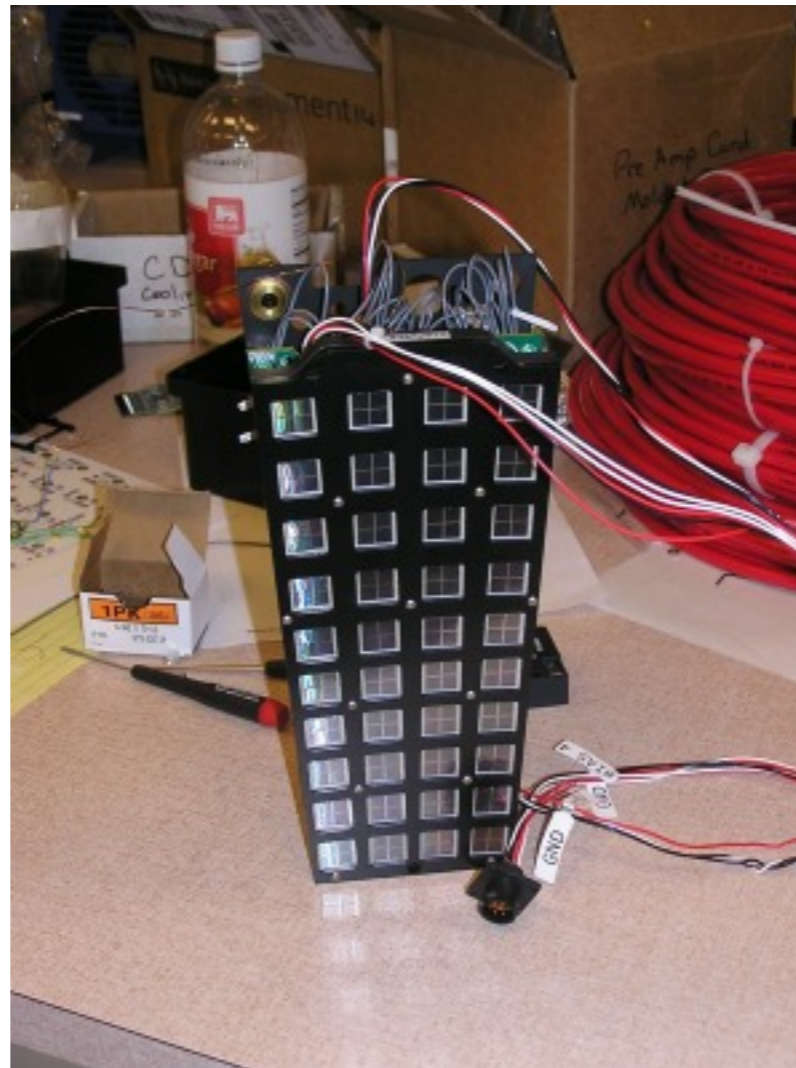

Calorimetry Working Group presentations & discussions

# Beam Test II - Objectives

---

✓ **Objective A:** Fully instrument this module with 40 production-version, large-area SiPMs on each end, coupled via production light guides, complete with their board electronics and mechanical assembly, coupled to Flash ADCs, F1 TDCs and read out by the planned Hall D DAQ and online system. This would afford the first ever comprehensive tryout of all aspects associated with the BCAL readout in a realistic beam environment and expose any issues that would require corrections or adjustments.

✗ **Objective B:** Collect data on the tagger floor at electron energies around 1700~MeV. **Constrain the floor term in the energy resolution**, previously measured at 2.3% (using a much shorter lever arm: 150-650~MeV). Also take data under the tagger alcove at around 275~MeV to anchor to past measurements and validate reconstruction code. **Also, install the LED-based monitoring system at least on two opposing BCAL cells, so as to investigate operation as well as optical cross talk.** **Got this done on the bench**

Ringing/noise complicated matters; technical difficulties



# Beam Test III - Setup

## Readout granularity, channel count

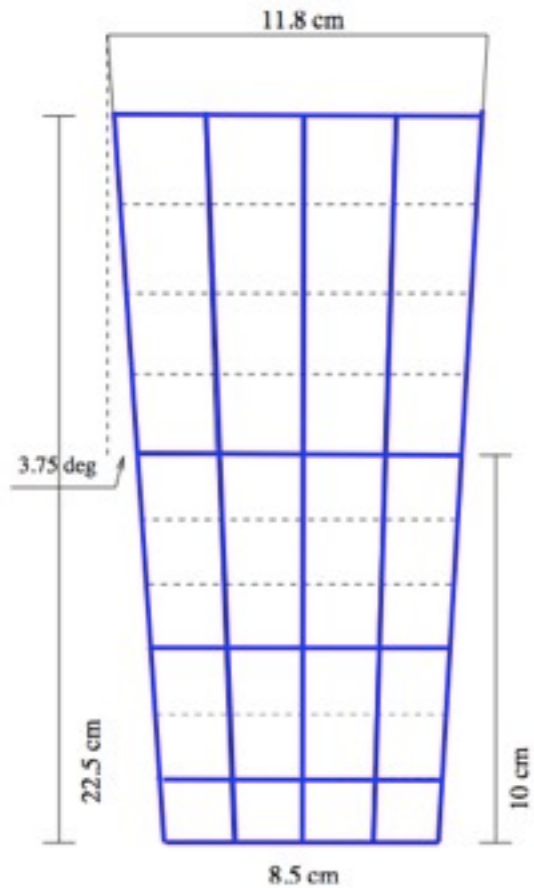

### Expected next week

- 2 preamp/sum and bias boards
  - 2x40 preamps
- 80 light guides from Santa Maria

### On-hand

- 3 Flash ADCs
  - 16x2 channels for mini-Bcal
  - 16 channels for trigger
- 1 F1 TDC
  - 12 channels for mini-Bcal
  - 4 channels for trigger
- Power supplies
  - Bias ~70V for SiPMs
  - +/- 5V for preamps
- Cables

- 200 lbs weight
- Keep SiPMs out of harm's way
- Couple pivot to middle
- Pivot to align to electrons
- Transition piece or rotate entire unit on floor



Positioner

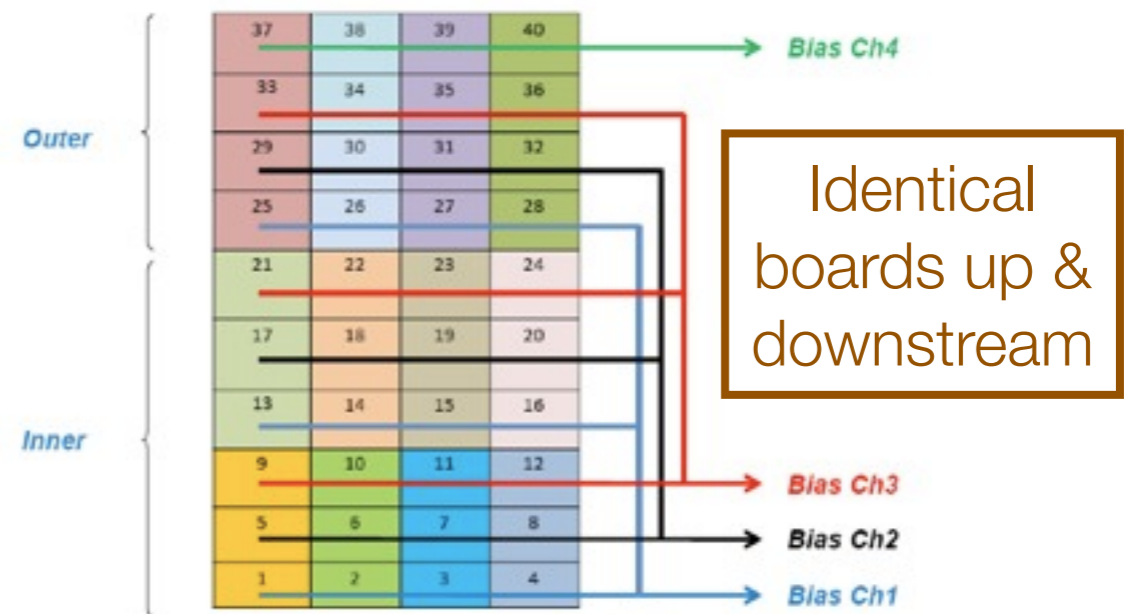

# Beam Test IV - Positions/Energies (A. Semenov, I. Semenova)

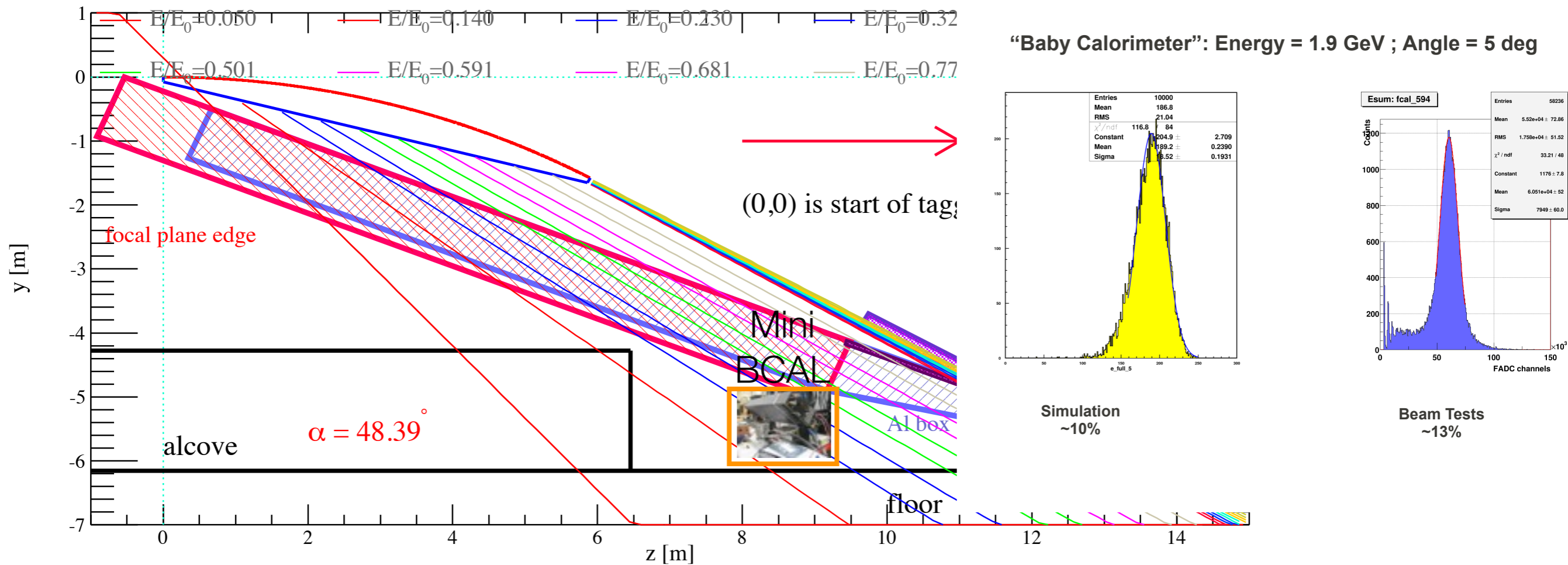

Set#1: 0.6GeV, 90 deg / Set#2 1.2GeV, 20 deg, Set#3 1.9 GeV, 5 deg

- Set#1 0.22E<sub>0</sub>, Temp 15-18 deg, mechanical fixes needed
- Set#2 0.22E<sub>0</sub>, Temp unstable, ringing in downstream board improved
- Set#3 0.35E<sub>0</sub>, Temp 11 deg, both boards improved (pileup...)
- Analysis continues: timing information



# Mini BCAL Bench Tests (T. Beattie, T. Bogart, E. Smith)

- SiPM Bias set to 74-75V (+1.2V overbias); cell summing, temp at 16<sup>o</sup> C.
- LED operation (one side): lower operational bias range ~6V; 42hrs stability: ±0.04%. Visible by eye.
- Far/Near ratio is good.
- Optical cross talk examined.
- Cosmic muons used to test SiPM signals; LED coupling
- Changes: bias distribution modification; ground traces, assembly procedure, gain dropped by x2.5
- Work continues.

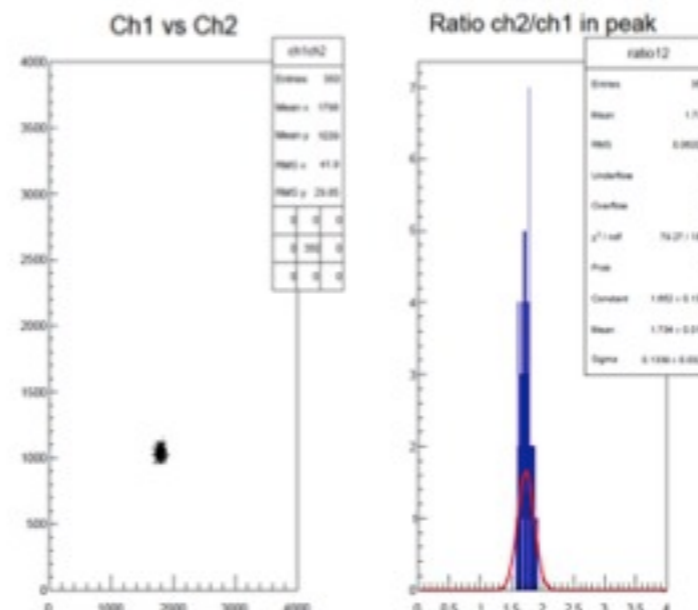
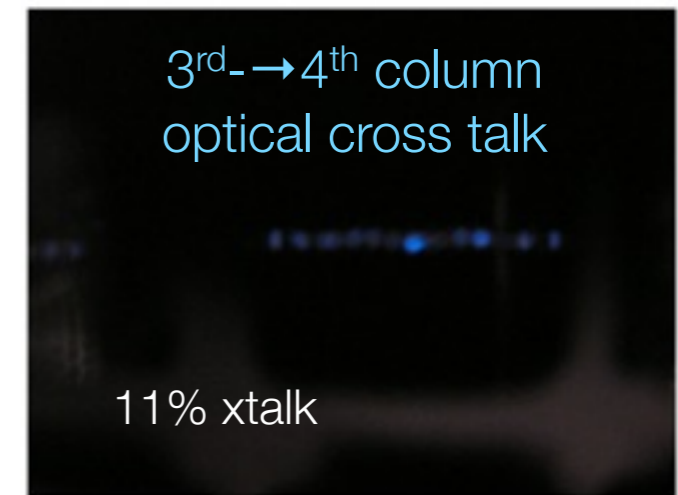

| Up/Down Ratio 2nd | Up/Down Ratio 3rd |
|-------------------|-------------------|
| 1.57              | 2.37              |
| 1.61              | 3.49              |
| 1.82              | 1.83              |
| 2.41              | 2.44              |
| 2.72              | 2.64              |
| 2.68              | 2.48              |
| 2.07              | 2.40              |
| 1.96              | 2.63              |
| 2.14              | 2.13              |
| 1.84              | 2.52              |

# SiPM Readout Assemblies (F. Barbosa et al., E. Smith)

- Two prototype boards tested during April-May Beam Test.
- These were modified over the summer and assembled into readout packages. The SiPM binning was employed to select units.
- Boards now have mirror arrangement: bias voltage inputs now power the same calorimeter cells for the upstream and downstream; fADC and TDC with the same no on downstream and upstream, correspond to same cell.
- Measured the response of the sensors to the monitoring LED light.
- Assembly process was streamlined and components were simplified.
- Amplifier gain was reduced by a factor of  $\times 2.5$ , although the gain of the TDC relative to fADC was kept at  $\times 5$ .
- Ground traces on the new boards were increased from 0.5 and 1.0 oz of Cu to 1.0 and 2.0 oz of Cu to reduce the ringing on the boards induced by large signals in adjacent sensors and coupled through the input bias.
- We have verified that the improvements over the prototype design will meet the design goals:
  - Output gain measured at  $\times 2.1$ ; ok, since overbias might drop to +1.2V.
  - Ringing substantially reduced to 7 counts above pedestal.
  - Summed output of the induced ringing noise is  $\sim 0$ .

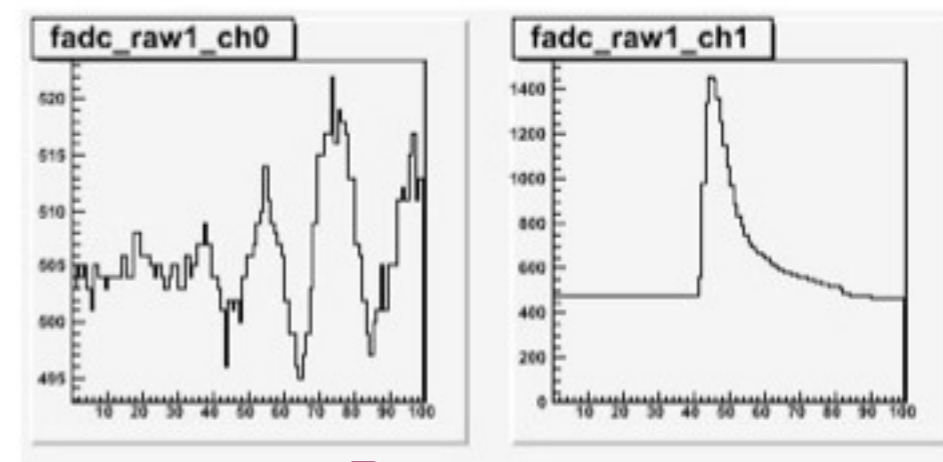

Prototype

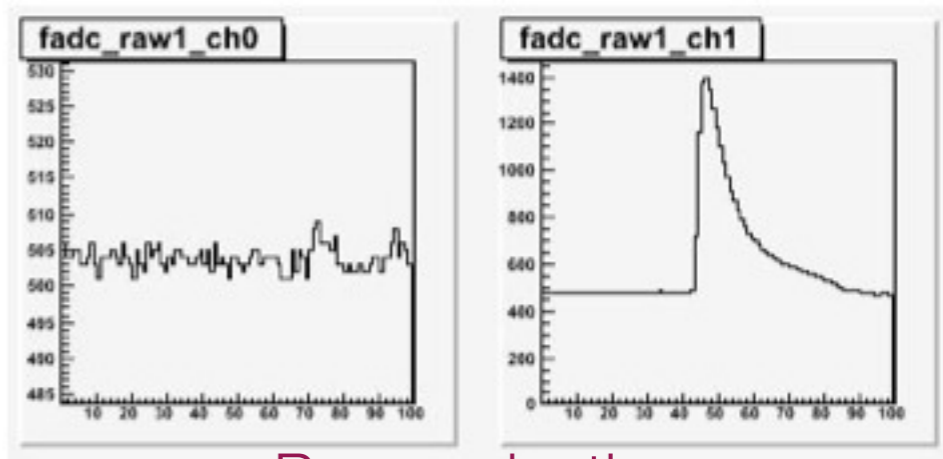

Pre-production

# Cosmics with SiPMs (T. Beattie, A. Fischer, S. Krueger, A. Semenov)

- Cosmic runs to extract fiber parameters using SiPMs

- Ham. R329-02 PMTs/grease/Winston Cone/grease

- 2010 Pre-prod SiPMs/dry/Chilean Guides/grease

- 5 trigger scint pairs

- ADC, TDC info

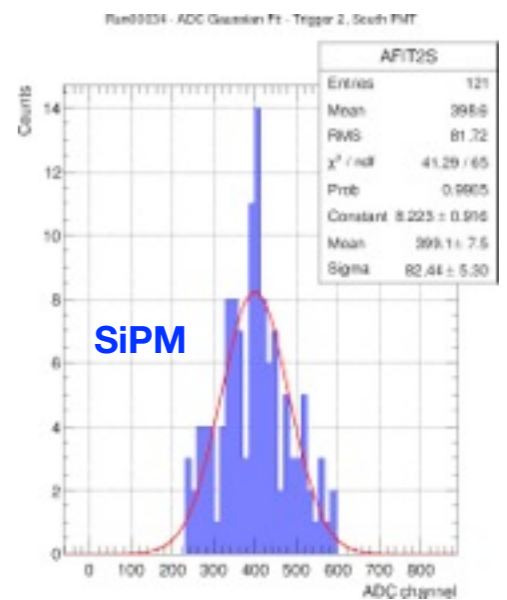
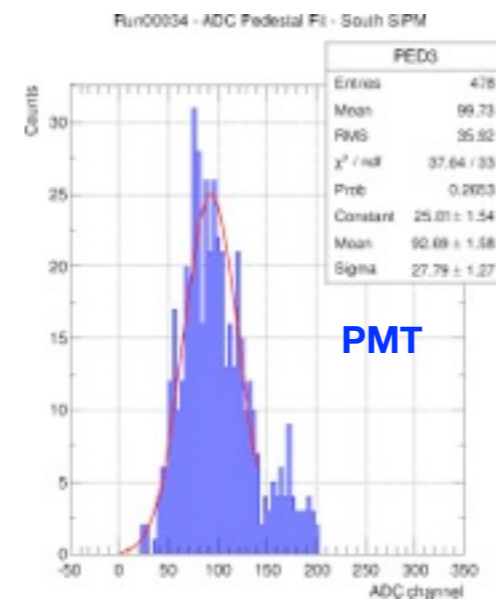
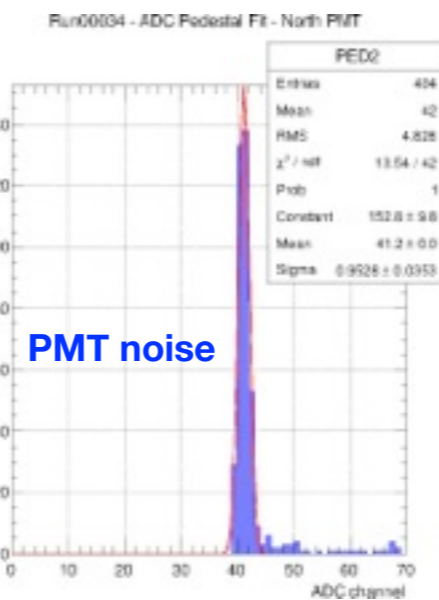
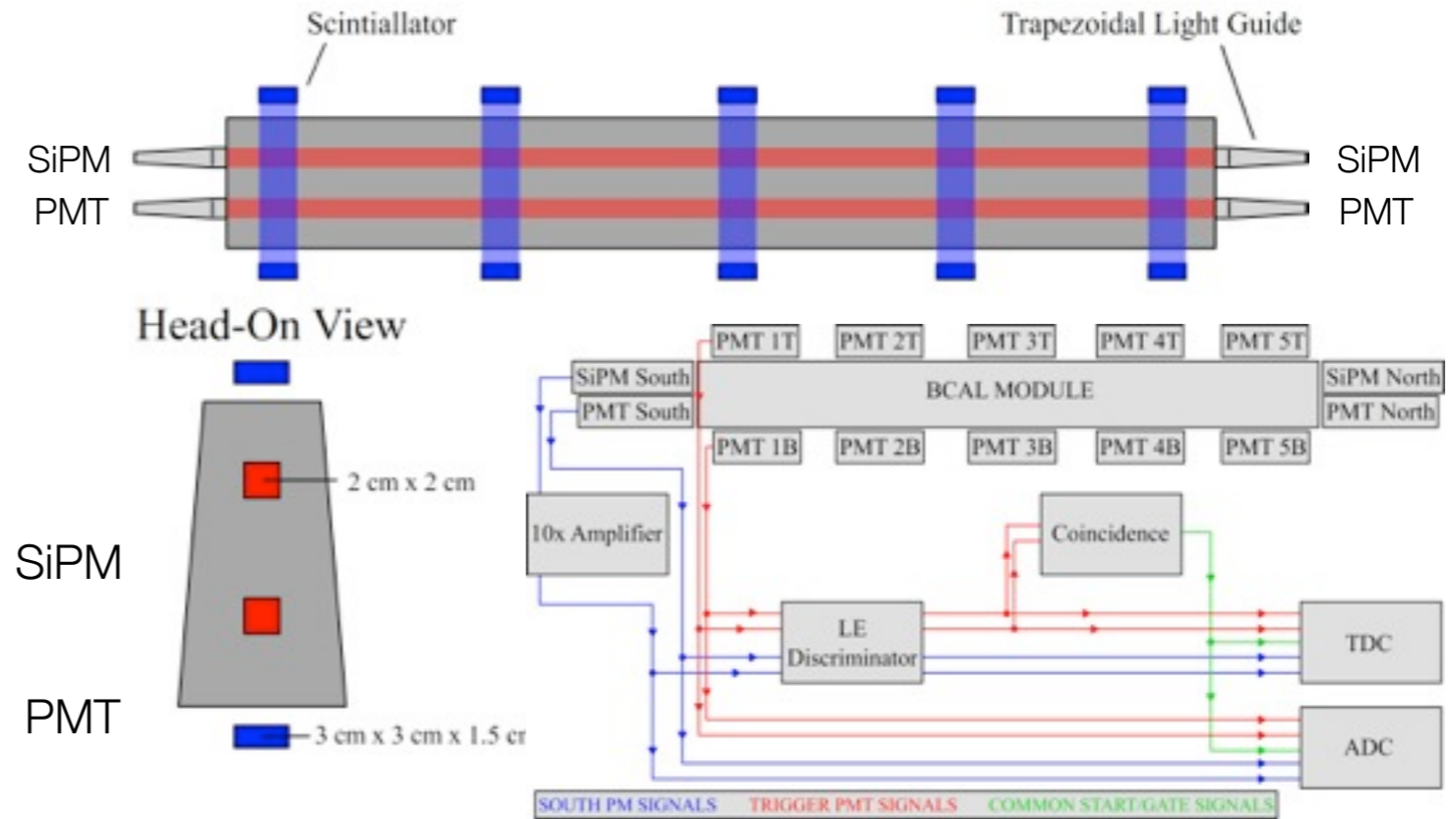



# Cosmics II

- AttenLen PMT =  $(325 \pm 5)$  cm
  - 2010 test:  $(318 \pm 6)$  cm
- AttenLen SiPM =  $(436 \pm 13)$  cm!
  - “Naked fibers”:  $(377 \pm 15)$  cm
  - Blue-green fibers
- Time-walk corrections
- Light Speed =  $(17.4 \pm 0.3)$  cm/ns for PMT
- Light Speed =  $(17.0 \pm 0.3)$  cm/ns for SiPM
- Timing Res PMT = 410ps
- Npe SiPM  $\sim 30$ p.e. - somewhat low, but still checking...

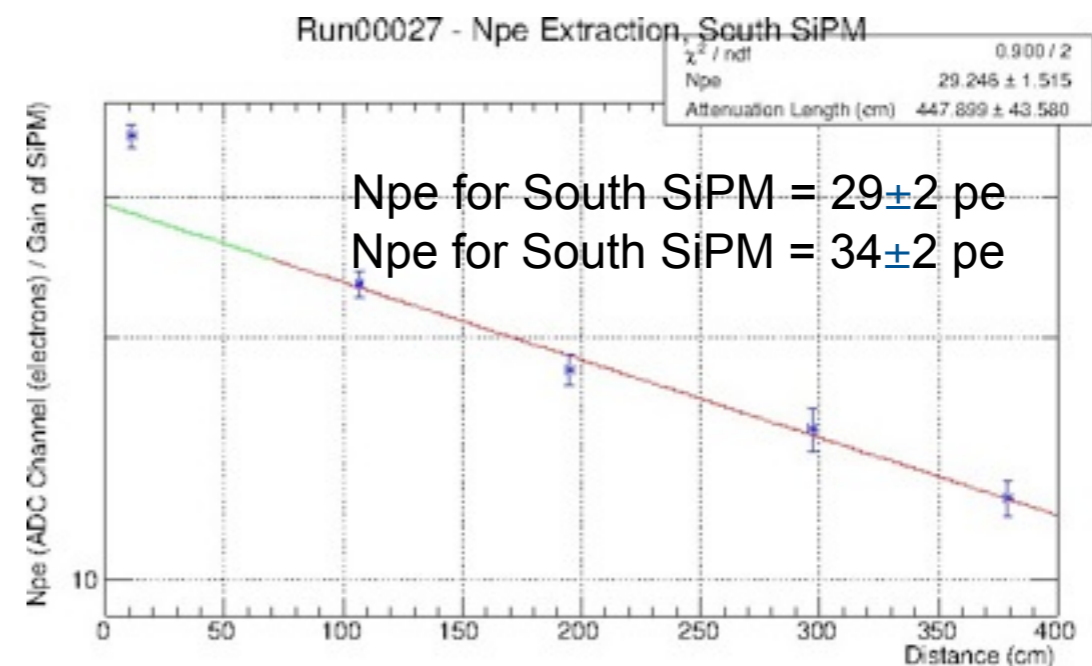
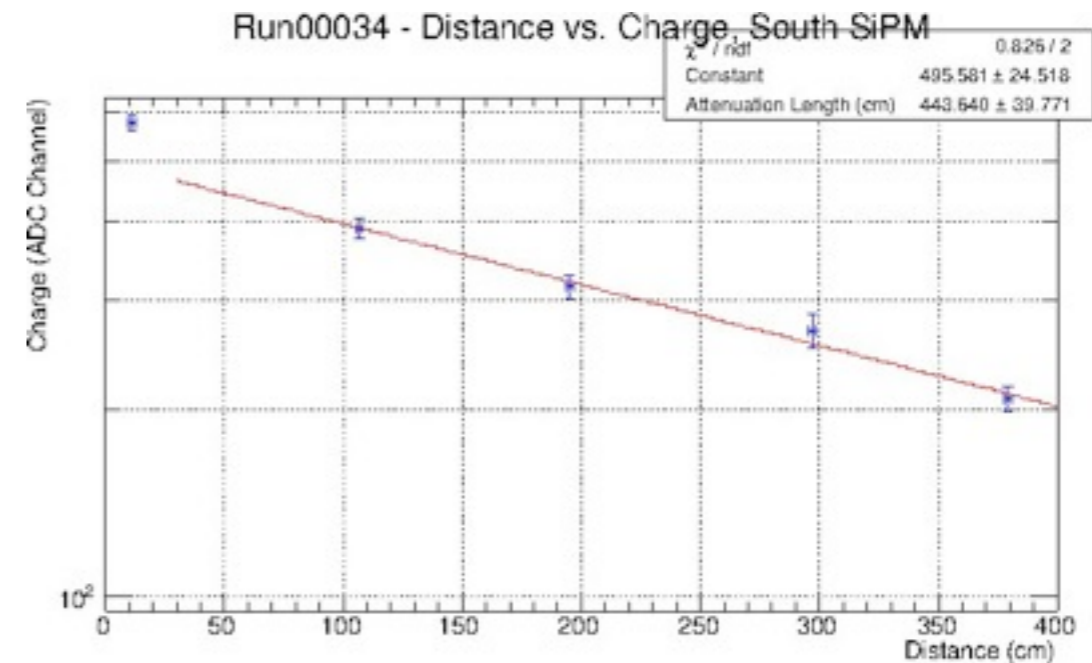

# SiPM Resolution using a UV Laser (S. Kruger)

- PicoQuant PDL 800-B laser
- 2.5 MHz frequency pulses
- 2 ms timer to slow count rate
- Bias supplied by Keithley 6487 Voltage Source
- Signals check on scope and fed into ADC

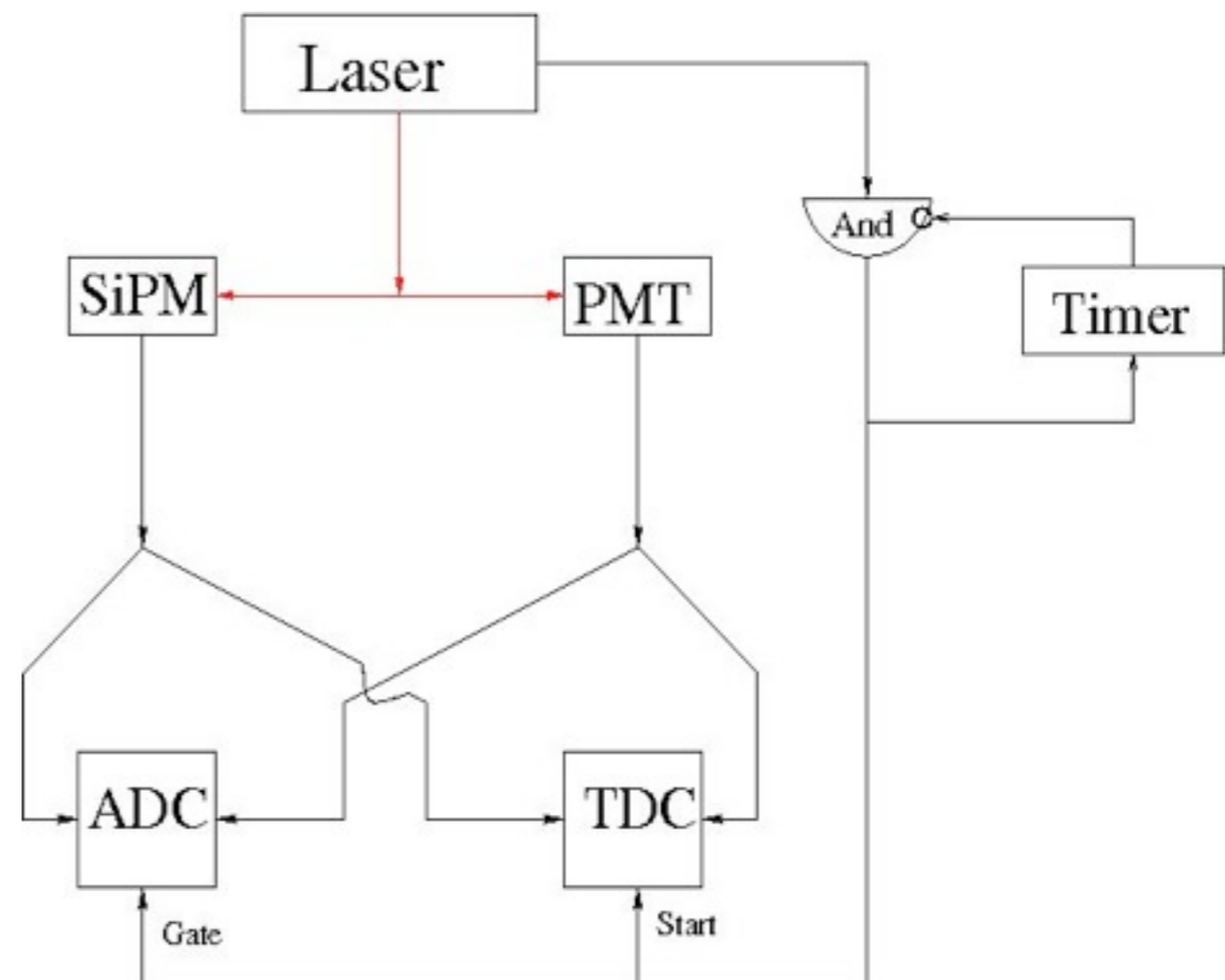

# SiPM Resolution II

- Plot of RMS/Corrected Mean vs bias
- Top: Laser Intensity 2.2 a.u.
- Bottom: Laser Intensity 2.6 a.u.
- Seeking minimum in resolution for our operation: uncertainty in breakdown bias value.
- $(70.79 - 0.9) \text{ V} = 69.89 \text{ V}$ , but we may be seeing a higher value

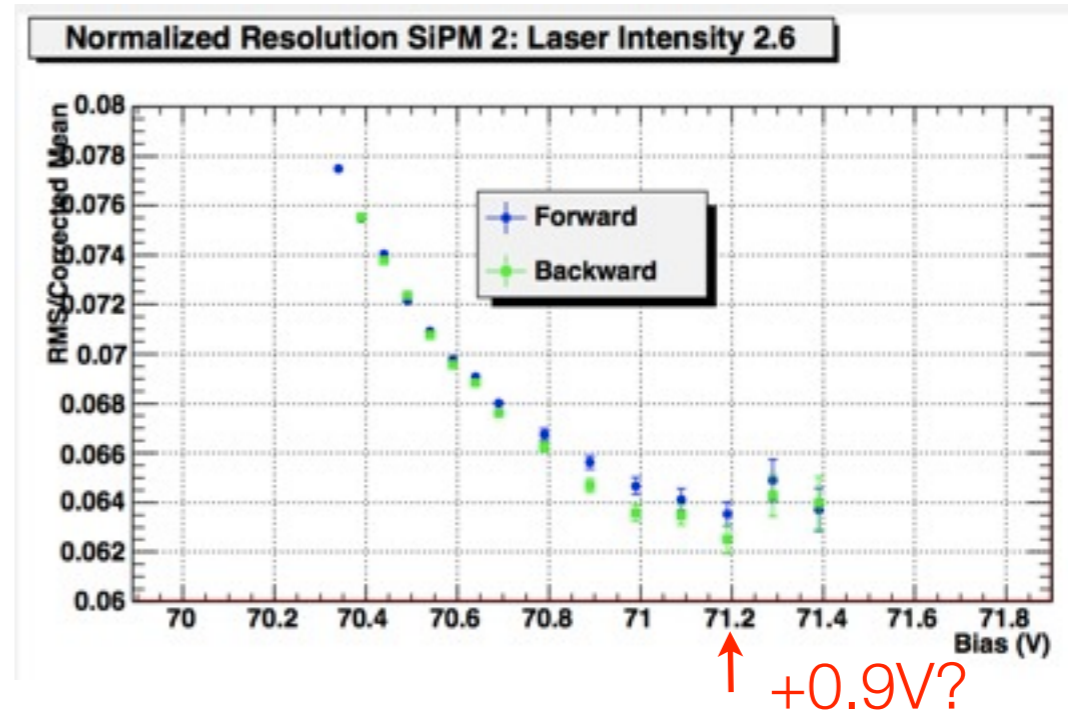
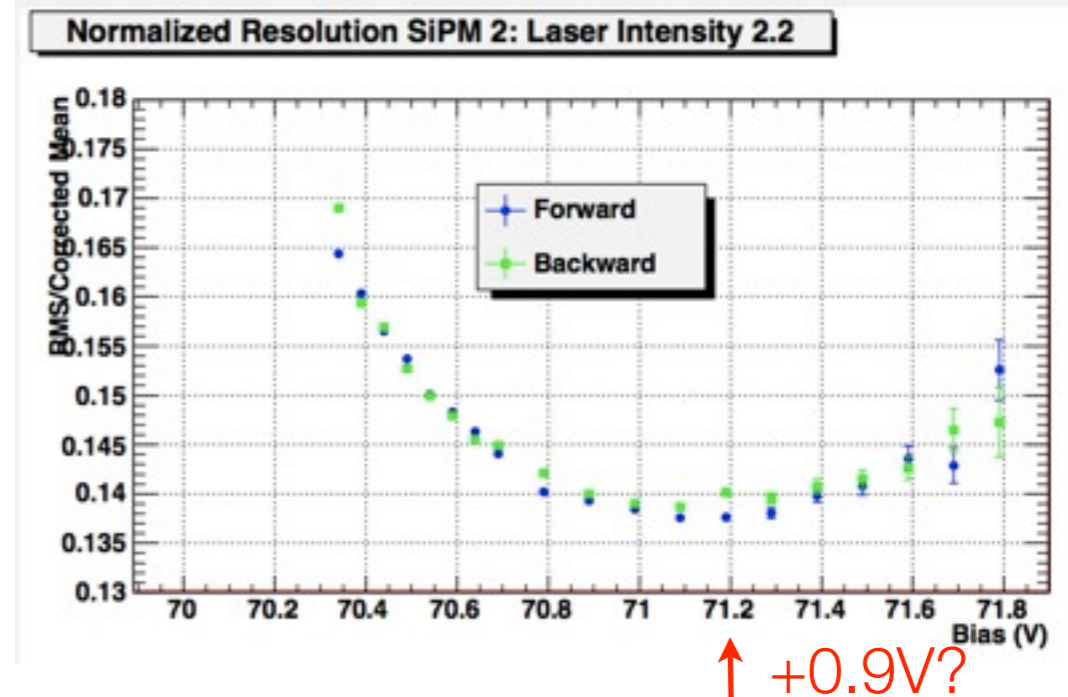



# SiPM Resolution III

- Plotted Dark Current ( $\mu\text{A}$ ) on log scale vs bias.
- Point of rapid growth indicates breakdown point: we don't see it quite yet.
- Limitation using ADC: down to 40 channels; next we will:
  - use x10 amplifier to zoom in
  - do conventional IV scan

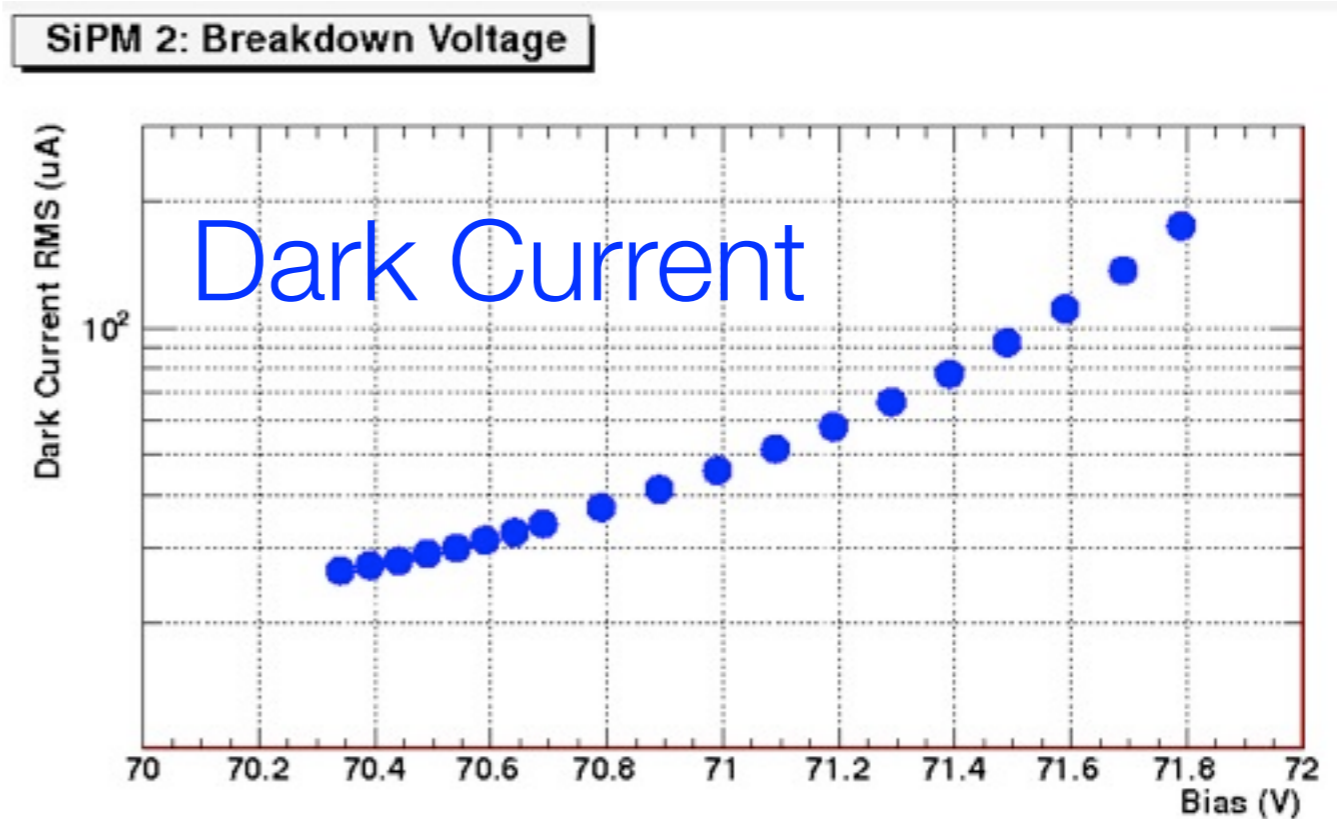

- Inside dark box
- No laser Light
- SiPM and Board are on

# SiPM Cross Talk & After Pulsing (Y. Qiang, I. Tolstukhin)

- Separate Xtalk and After Pulses
- Measure the dependence of Xtalk and After Pulses on bias
- Time constant of After Pulses
- 4 SiPM Array units
- 0.6-1.4 V overbias scan
  - Hamamatsu suggests +0.9V
  - Our plan was at +1.2V
- 0%-6.3% intensity scan
- Gate 150ns-1μs

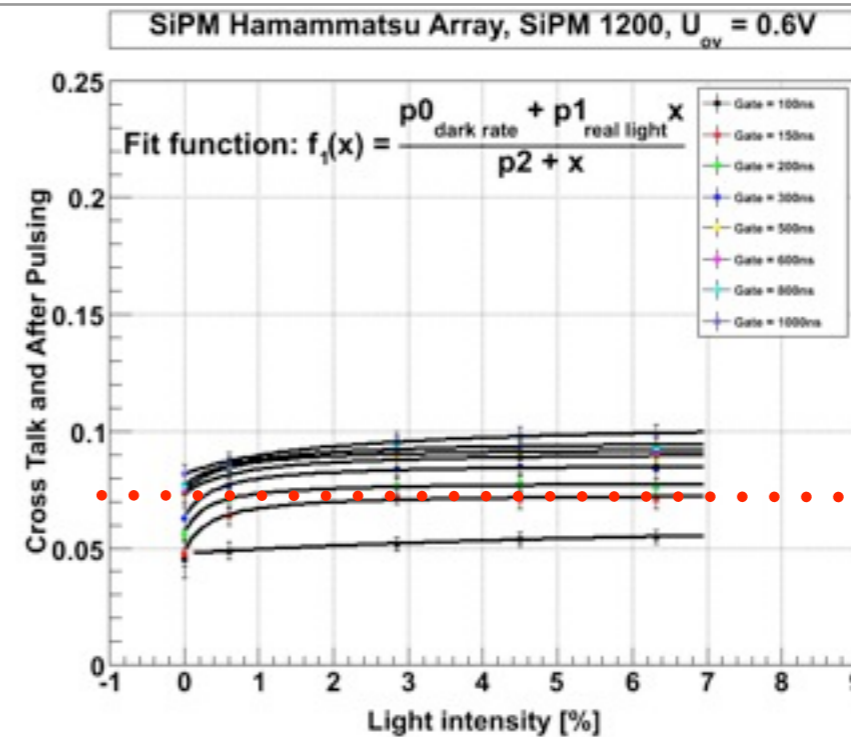

+0.6V

150ns gate

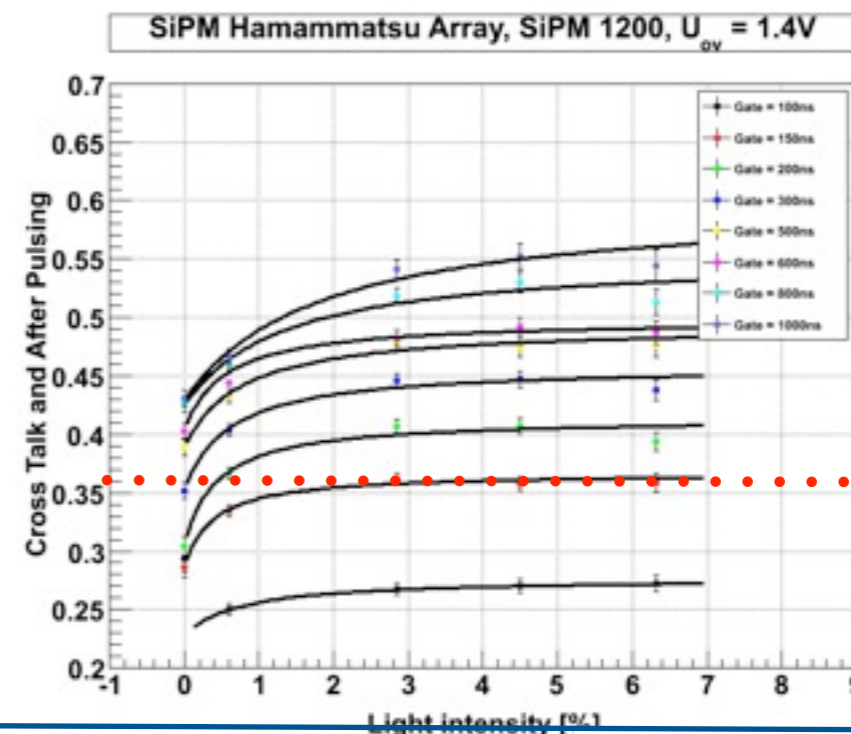

+1.4V

150ns gate

# SiPM XTalk & AP II

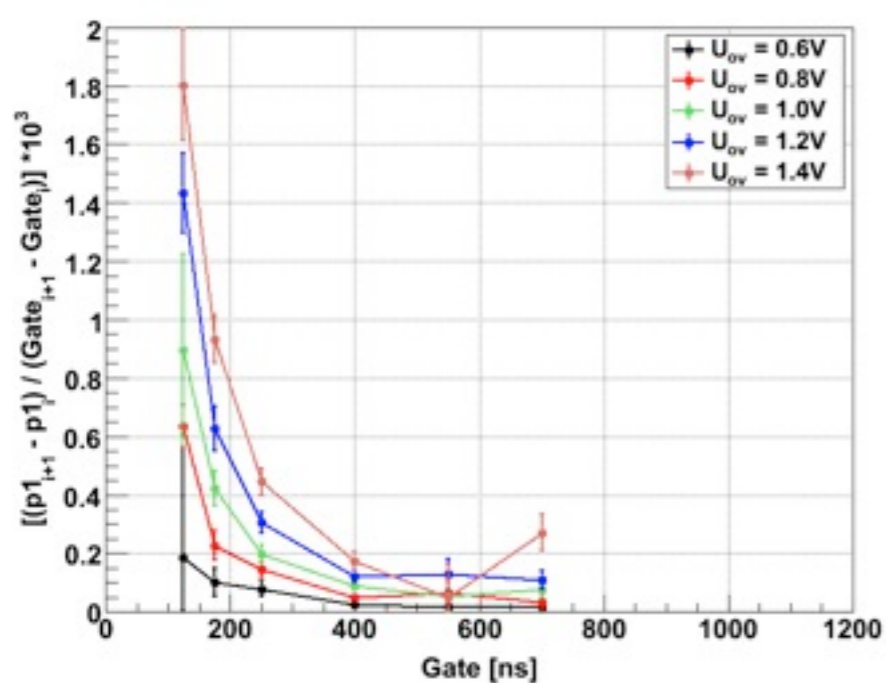
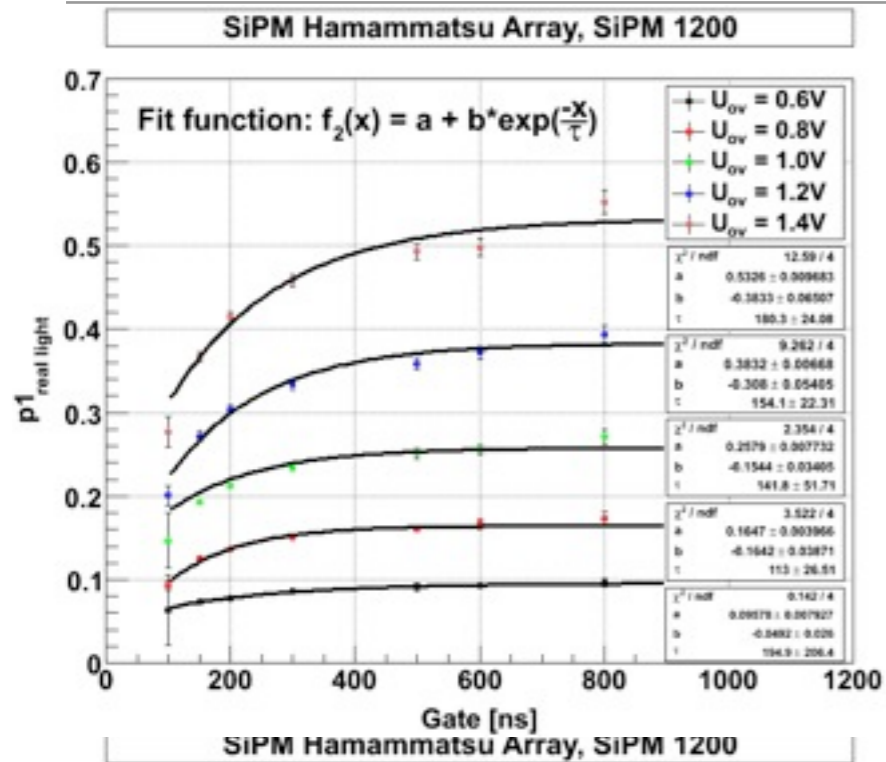

- The total Xtalk and After Pulses for real light as a function of the gate for different overvoltages and SiPMs.
- $f_2(\infty) = p_0 = \text{After pulses} + \text{Xtalk}$
- $f_2(50 \text{ ns}) = \text{Xtalk}$  (50 ns – gate start to signal max)

Time constant of the Xtalk and After Pulsing

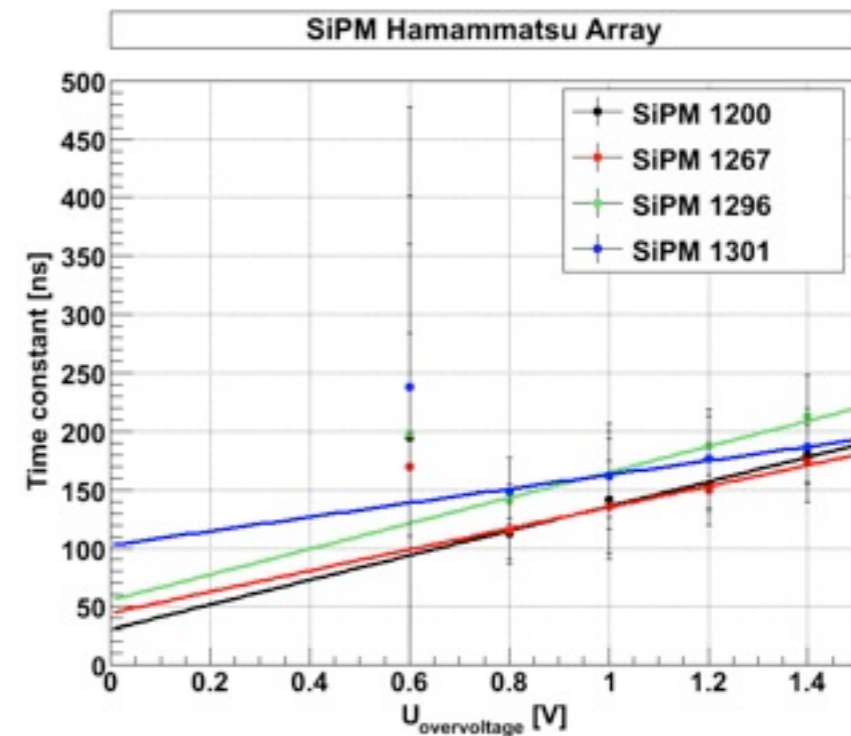



# SiPM XTalk & AP III

- Method results in disentangling Cross Talk from After Pulsing
- Results show values quite high at +1.2V (ca 20% EACH!)
- Consider operating at +0.9V-1.0V (close to Hamamatsu operating bias)

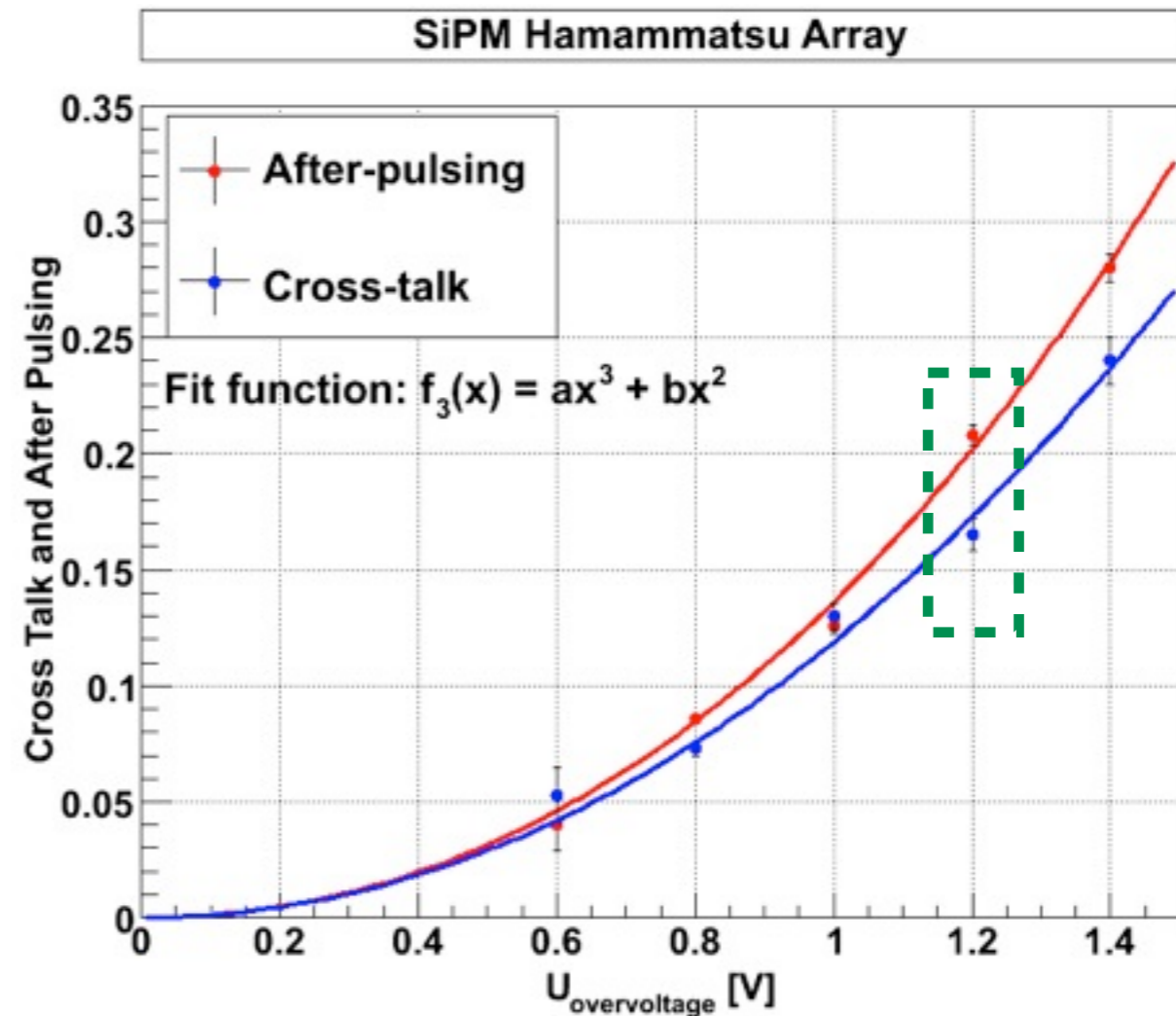

# Sampling Fraction Simulation (A. Semenov, I. Semenova)

- Currently we use a single value for the S.F. at 9.5% across all cells, for all energies and angles.
- Simulate/understand the fine grained behavior, and include in a look up table/parametrization
- Challenge in fitting tails.
- Work is going well, hope to bring to a conclusion and update the code.

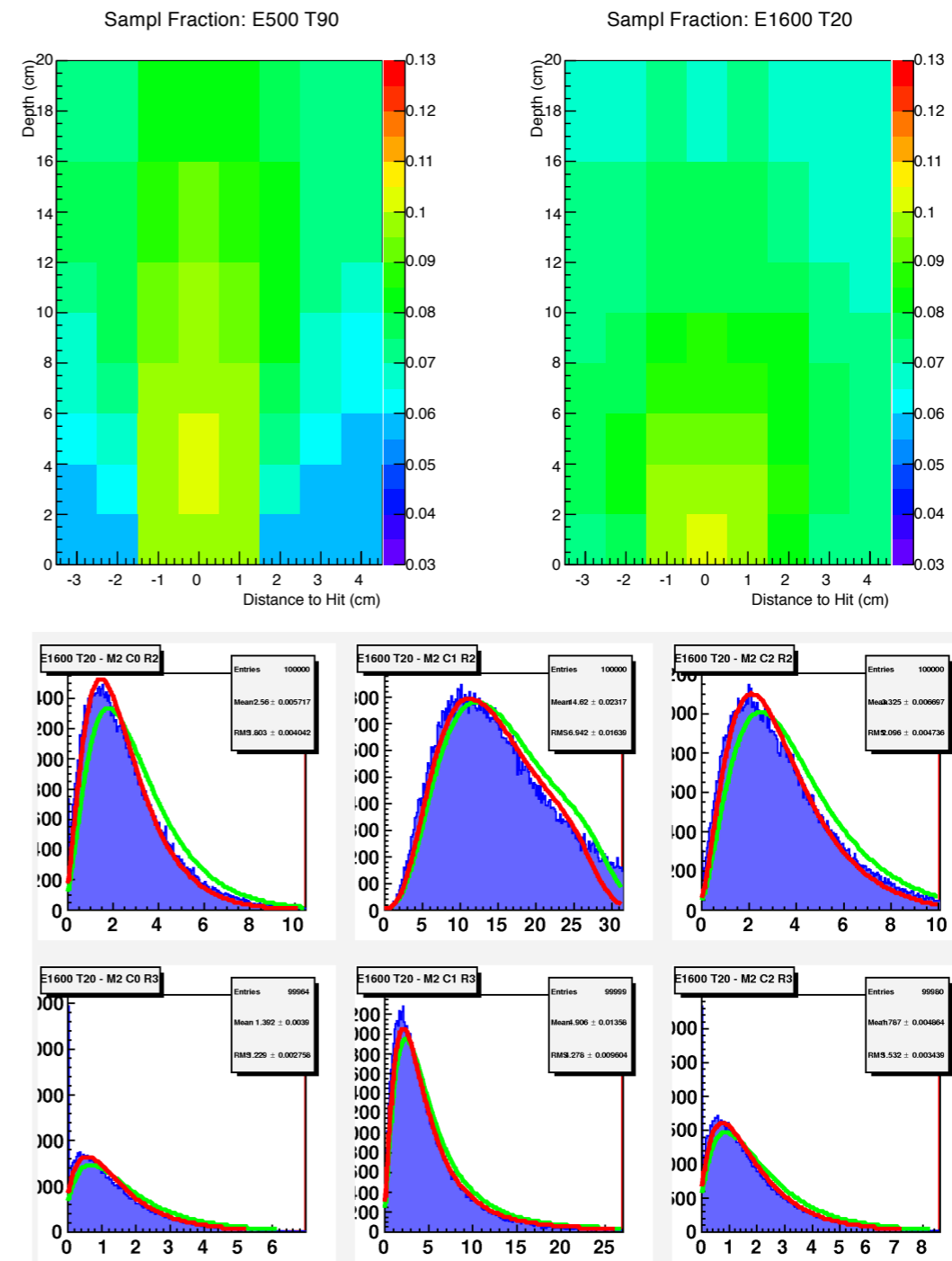

# BCAL Simulated Signal Formation (D. Lawrence)

- **Realism in code**; push towards calibration db usage, detail sampling fraction application
- Energy weighted timing spectra are written out for each SiPM from hdgeant
- Smearing stage (mcsmear) adds in several resolution effects and forms electronic pulse shape
- Threshold crossing (4mV) is used to set integration window and determine timing of pulses
- Separate TDC hits are generated using different threshold (45mV)

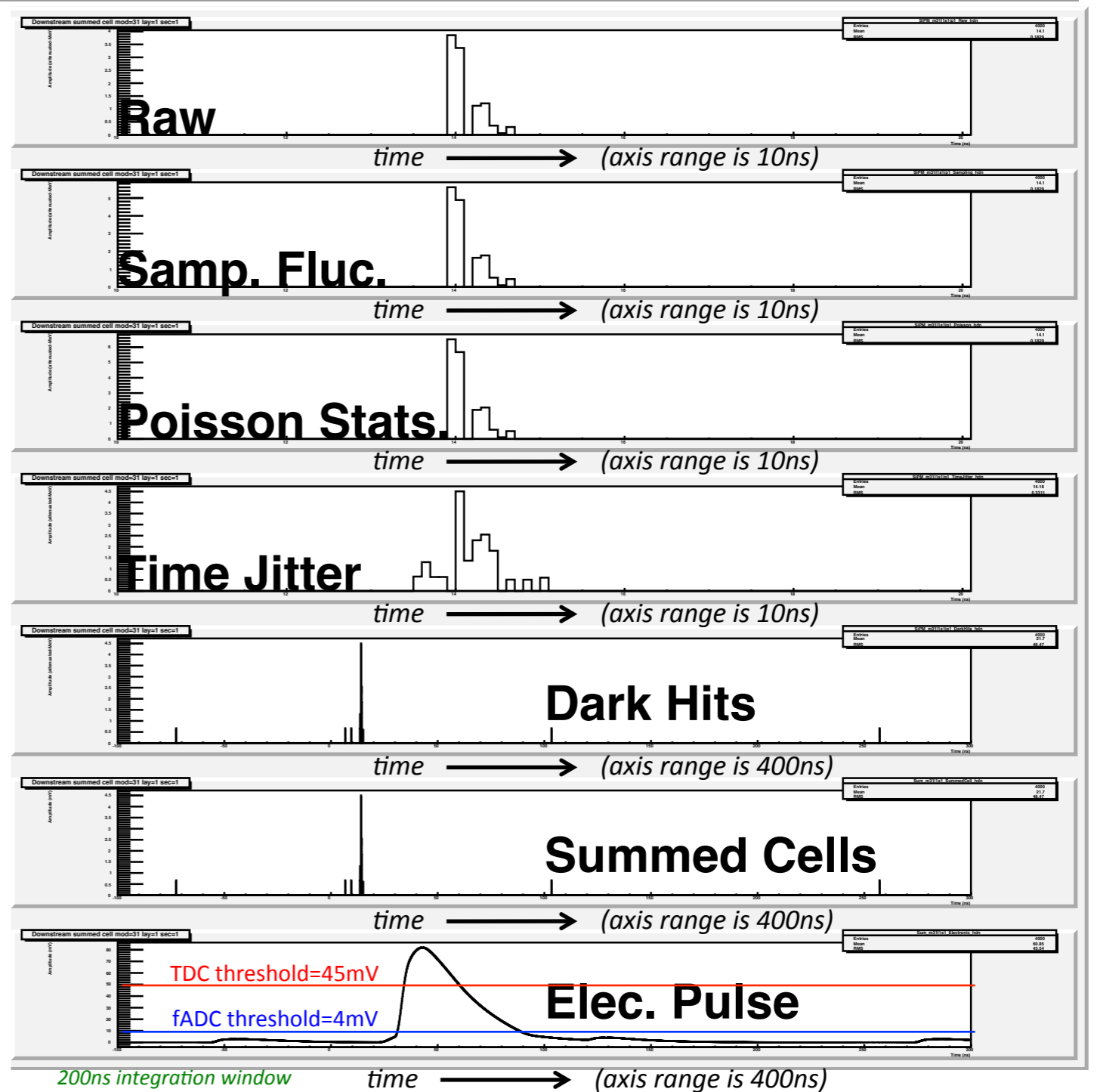



# BCAL Energy Resolution From Simulated Data

(IU algorithm)

Multiple sets of mono-energetic photons simulated and reconstructed

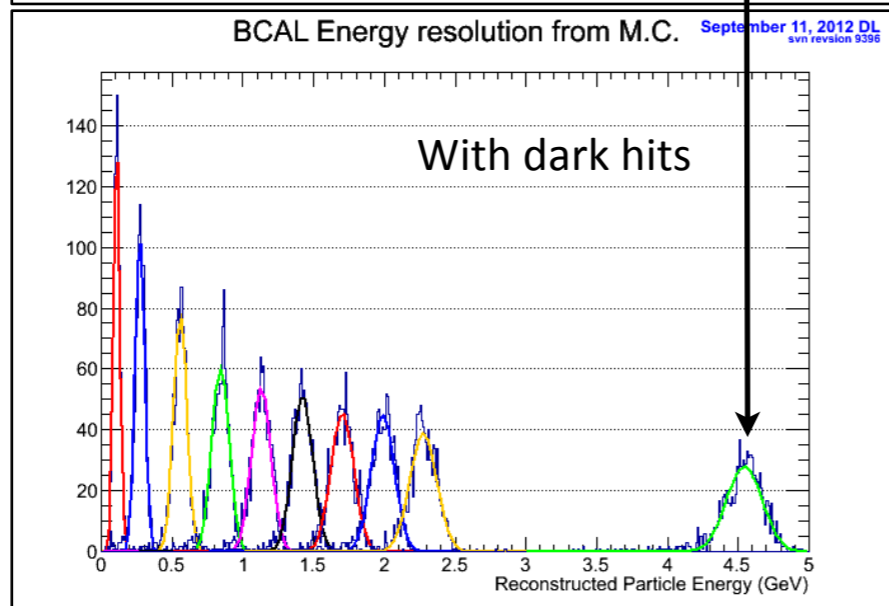
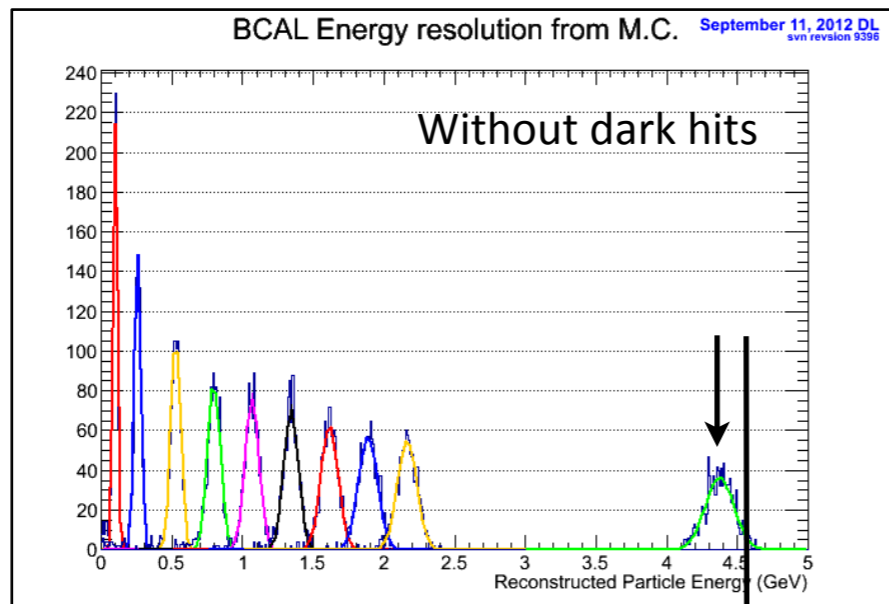

- Reconstructed peak fit to Gaussian
- $\sigma$  over mean of fit determines resolution (see next slide)
- Dark hits pedestals not subtracted leading to slightly better  $\sigma/E$  resolutions than we actually expect

Each cell included in cluster contains dark hits which effectively increase the pedestal. No pedestal subtraction was done for the current plots.

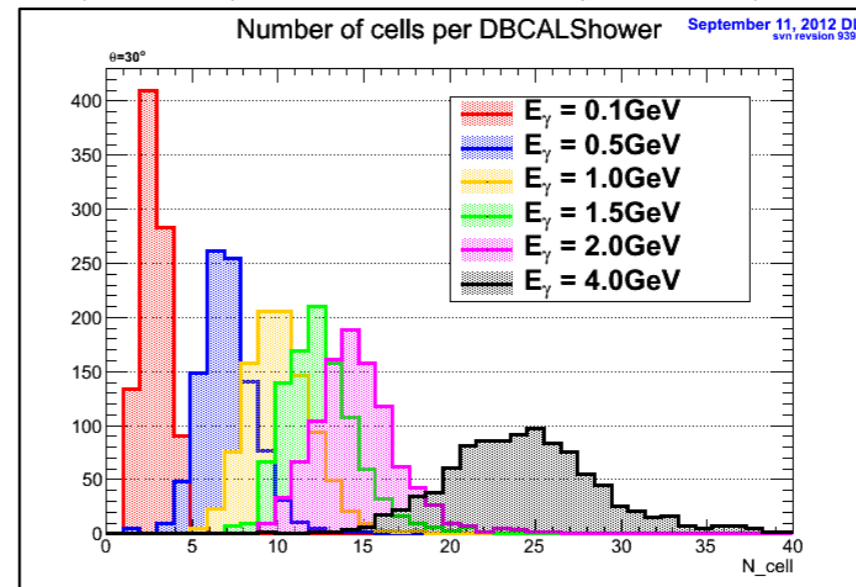

# BCAL Energy Resolution II

BCAL Energy resolution from M.C. September 20, 2012 DL  
svn revision 9396

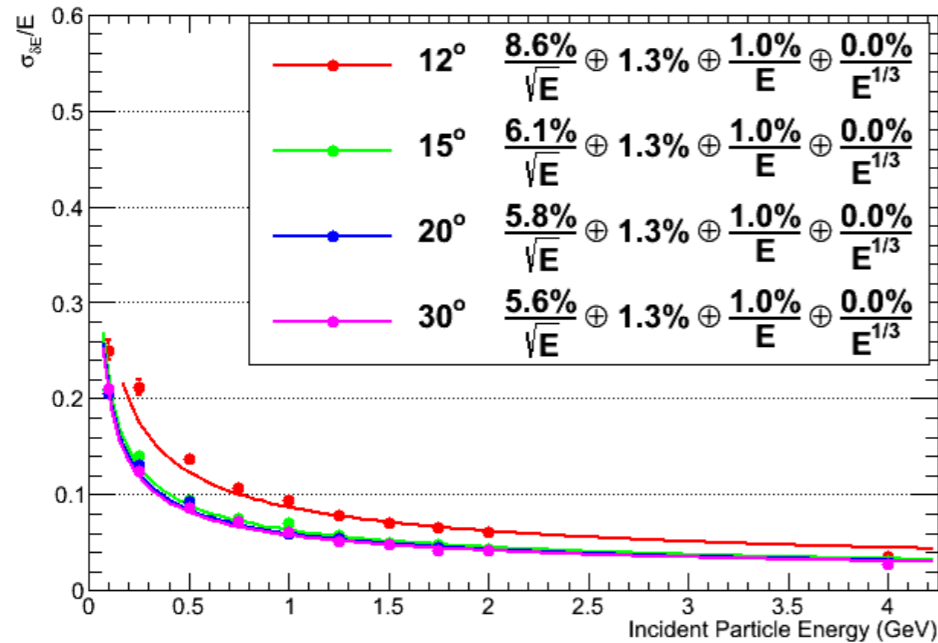

BCAL Energy resolution from M.C. September 20, 2012 DL  
svn revision 9396

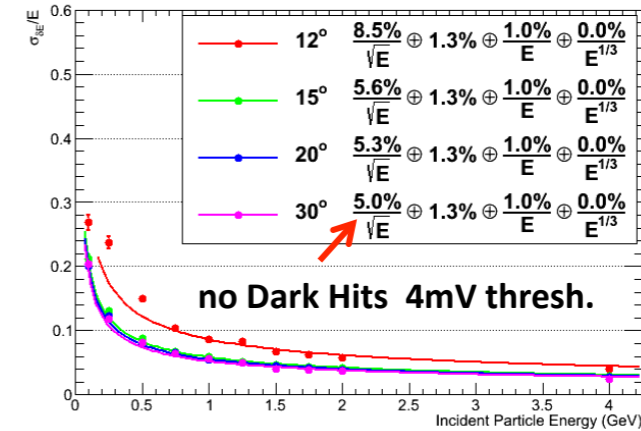

BCAL Energy resolution from M.C. September 20, 2012 DL  
svn revision 9396

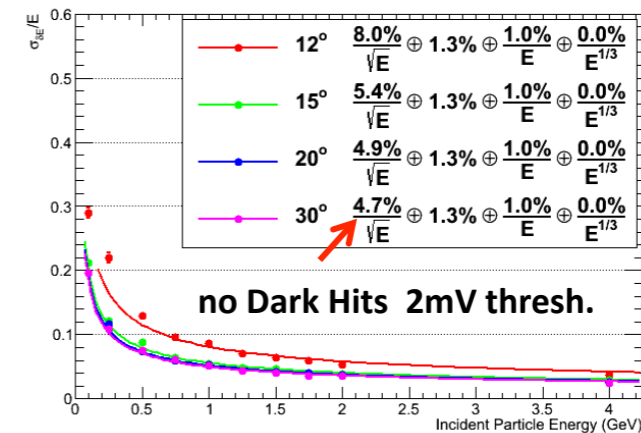

BCAL Energy resolution from M.C. September 20, 2012 DL  
svn revision 9396

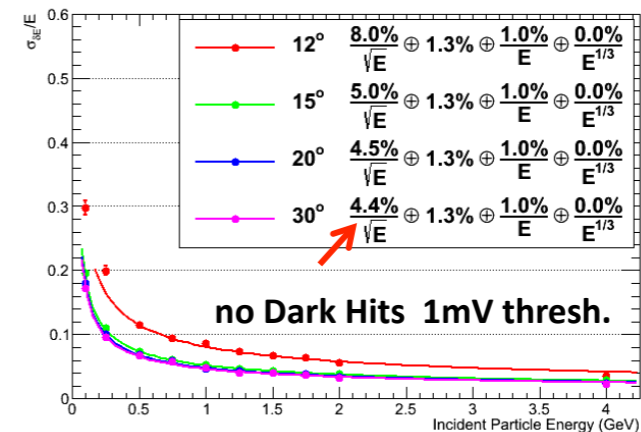

- Smearing includes 4.2% stochastic ( $1/\sqrt{E}$ ) term and 1.3% floor term as input
- Fits include noise term fixed at 1.0%/E and floor term fixed at 1.3% (only  $1/\sqrt{E}$  term allowed to float)
- Dark hits add  $\sim 2.5\%/\sqrt{E}$  for 15°, 20°, and 30° data
- 4mV Threshold adds  $\sim 2.5\%/\sqrt{E}$  for 15°, 20°, and 30° data





# what's next?

---

- LG & LED gluing; installation (T. Whitlatch talk)
- Simulation/Reconstruction efforts: (E, $\theta$ ) grid into code, etc.
- SiPM Evaluation:
  - finalize expected performance characteristics
  - understand optimal starting performance
- Beam Test: finish analysis, look at timing information.
- Calibration: carry out studies.
- TDR: continue working on it in the fall, finalize BCAL part by Feb meeting.