

# **Linearity Test of the Active-base Amplifier**

Sasha

JEF meeting, 11 February, 2021

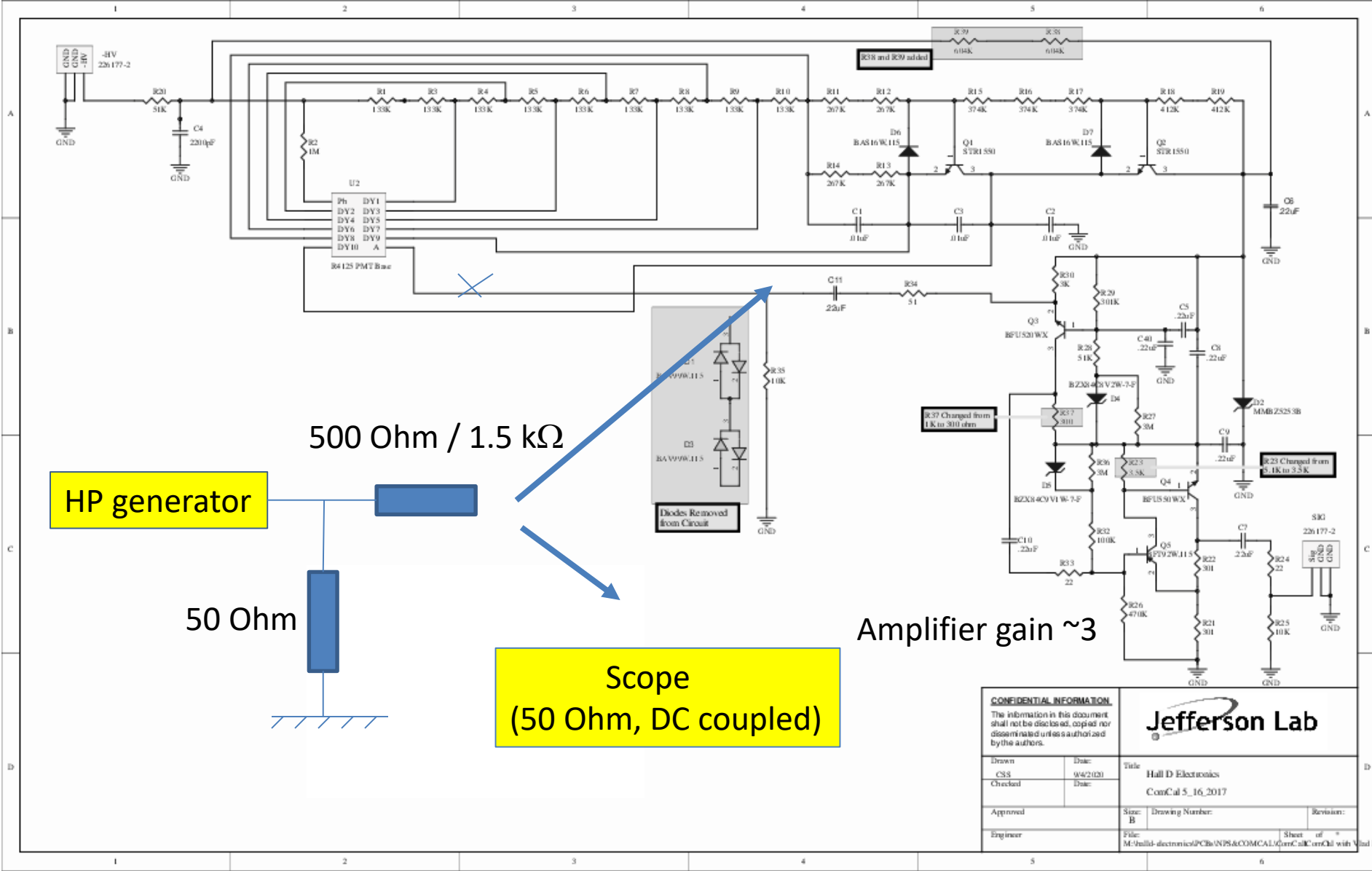

Possible bias/systematics of measurements (?)

## Signal pulse from generator

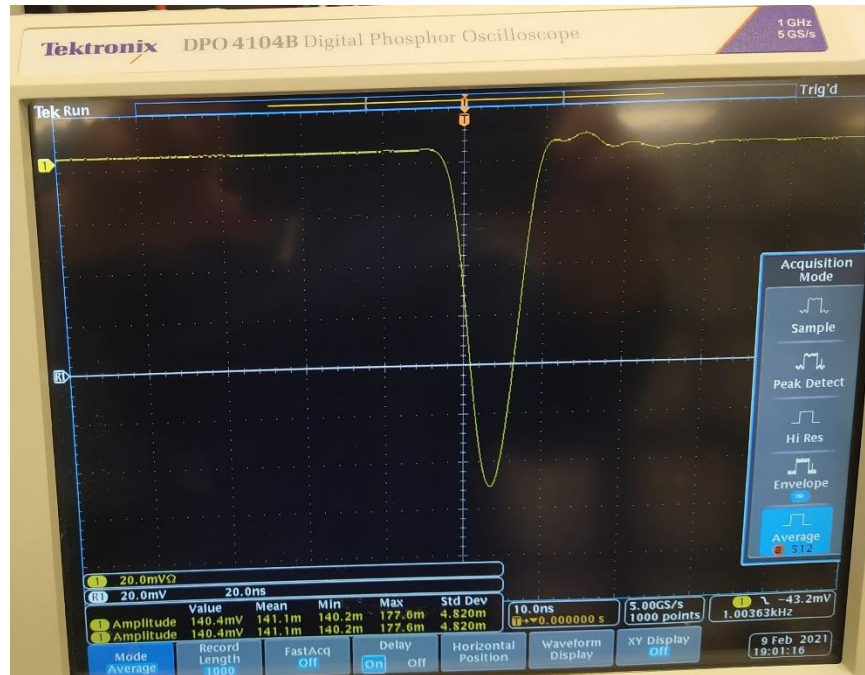

## Amplified signal pulse

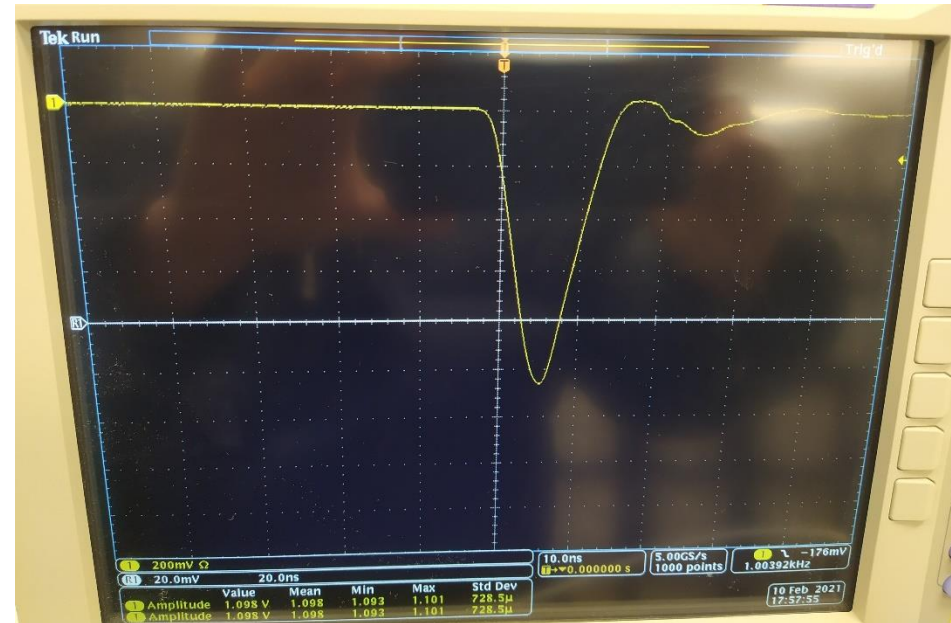

full width ~10 ns

# Amplifier Gain ( $A_{\text{amp}} / A_{\text{HP}}$ )

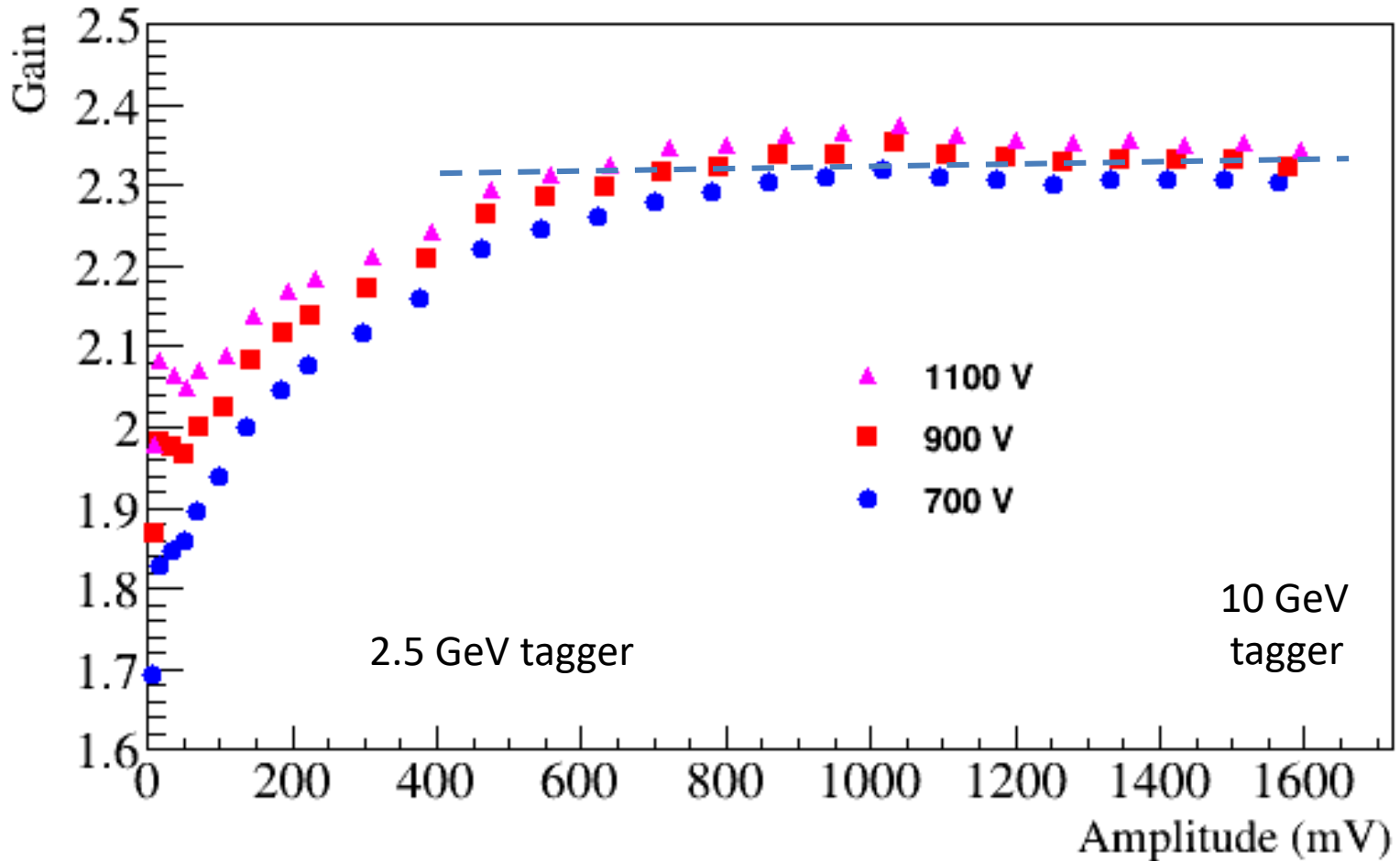

- Relatively stable gain for large amplitudes between 0.5 V and 1.6 V
- Non linearity on the level of 10 % below 0.5 V

# Non linearity for different divider current

700 V - 700  $\mu$  A  
900 V - 900  $\mu$  A  
1100 V - 1.1 mA

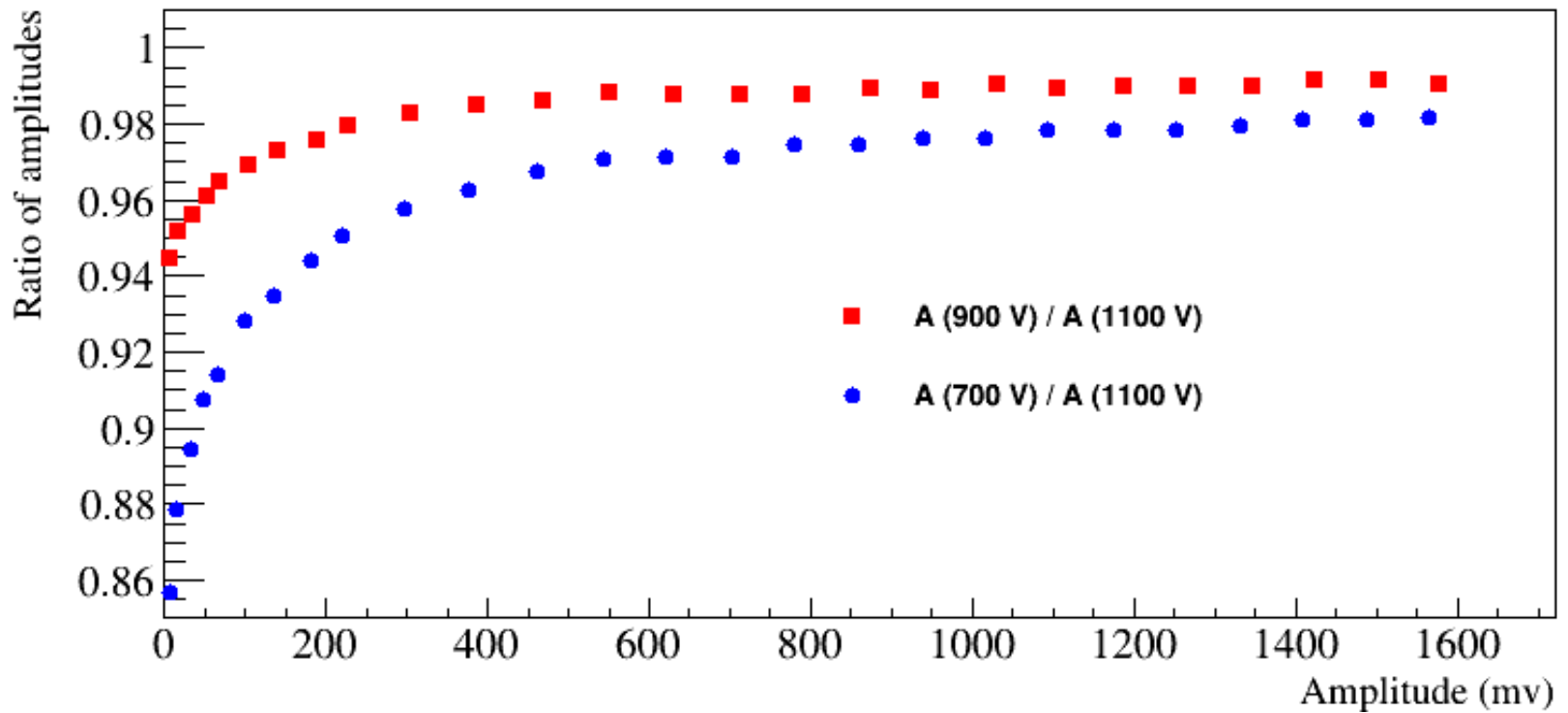

- Better linearity at larger divider currents

# Discussion

Measured gain verified our beam tests results  
(if measured the gain correctly . . . )

FCAL:

- An amplifier will be needed for inner FCAL insert layers, though with a relatively small gain between 3 and 6.
- Possible solutions to improve the amplifier:
  - use on-board amplifier, provide additional power to the amplifier (decouple power for divider and amplifier), use one extra cable to each PCB
  - use external amplifiers for modules in inner layers (place inside dark room ?)
  - apply non-linearity corrections for already existing bases

# Discussion

## CCAL:

- Estimated the anode current to be relatively small for PrimEx runs, a few micro amps. We can operate the base without an amplifier (use an amplifier with a small gain x3 as a backup) .

Note, we can change the ADC voltage range from 2 V to 0.5 V, if really needed

- Performance of the modified divider with the stabilization on last dynodes is good (checked)
- Order dividers for the CCAL with a switchable gain bypassed (default) / gain of 3 (optional, exists on the PCB)

# Amplifier Gain ( $A_{amp} / A_{HP}$ )

Use different 'injection' resistors.

compare measurements for 500 Ohm and 1.5 k $\Omega$

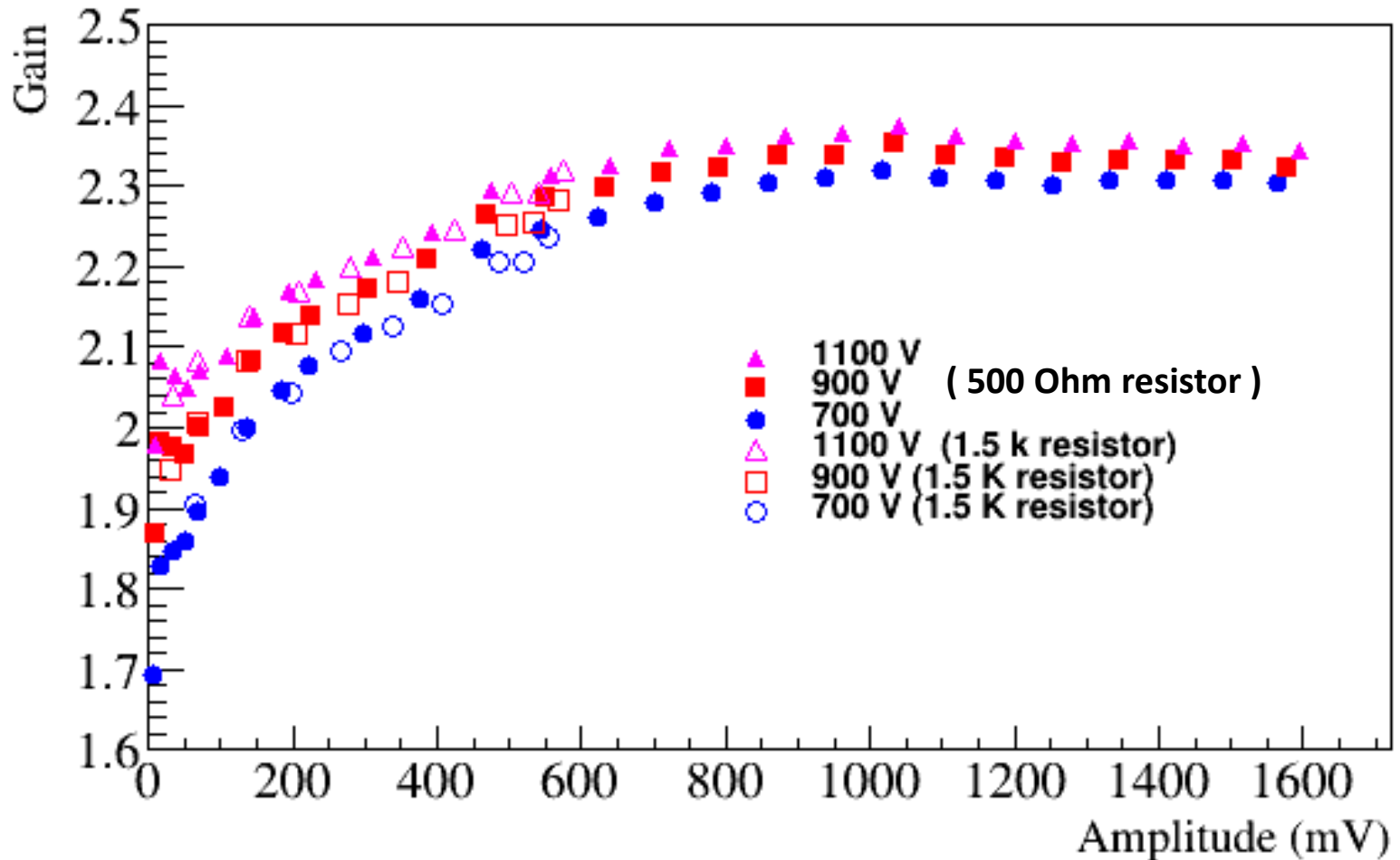



# Modifications of the base

V, Popov

Some attempts to linearize performance

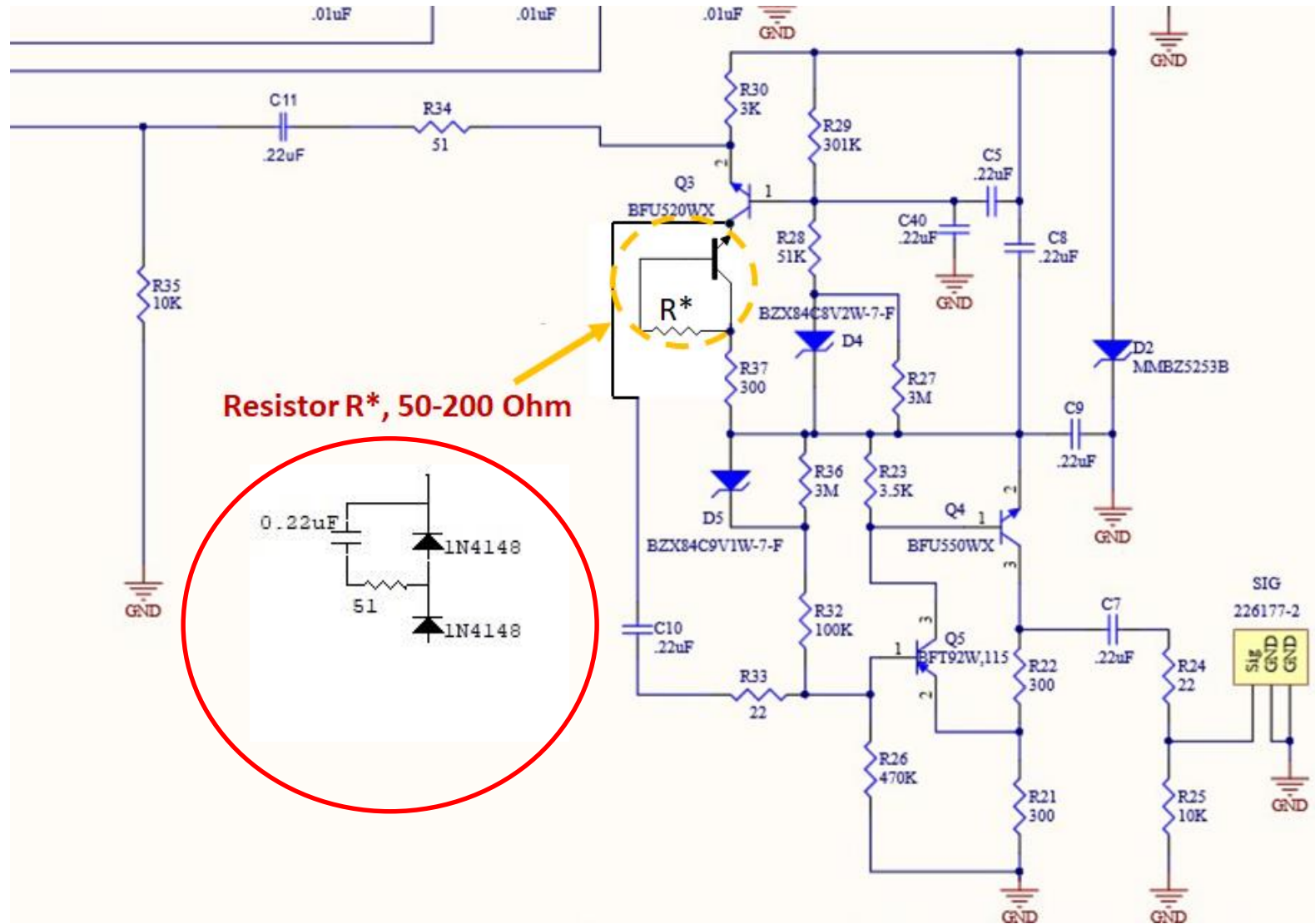

# Amplifier Gain ( $A_{amp} / A_{HP}$ )

## Default amplifier

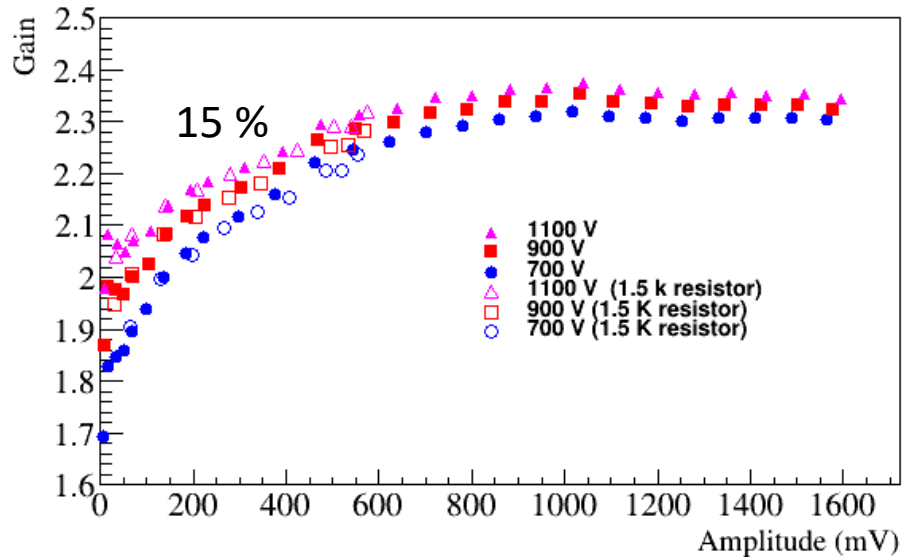

## Add a diode

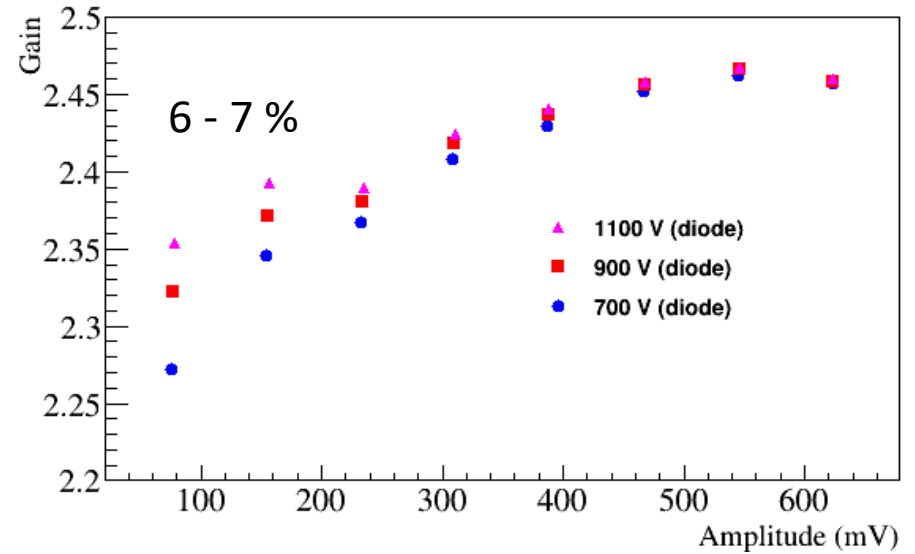

# Two diodes

HP resistor 1 k $\Omega$

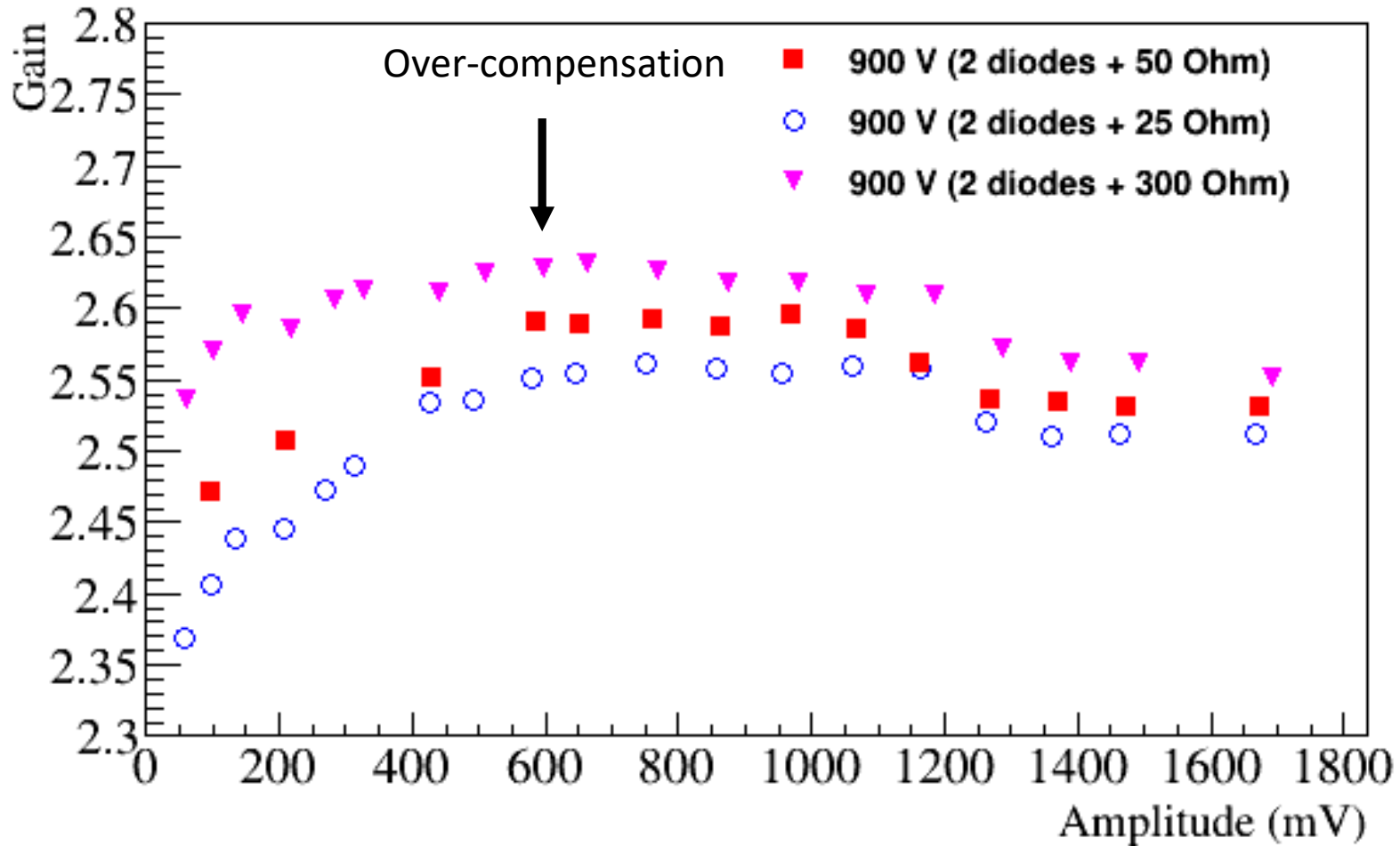

# Discussion

- Test 1 – 2 options
- Start redoing dividers for CCAL.

Default: bypassed amplifier

Optional: gain of 3, the best we can get  
no space on the existing PCB for the 2-diode scheme

- May continue with the divider optimization when the lab is re-opened
- Consider on-board OPS bases amplifier (Fernando's design)  
- perform tests in the lab
- Prepare new dividers and install them after the PrimEx run  
- test with the SRC experiment during this year

# Single Diode

$$R_{HP} = 1 \text{ k}\Omega$$

