



THOMAS JEFFERSON NATIONAL ACCELERATOR FACILITY  
12000 Jefferson Avenue  
Newport News, VA 23606

HALL D PROCEDURE NO.:  
D000000-01-06-P007 Rev -

TITLE: Hall D FCAL2 Assembly Procedure

DATE: 06/01/2023

BY: Keith Harding

APP: Tim Whitlatch

CHK: Scot Spiegel

APP: \_\_\_\_\_

REV.	DESCRIPTION	BY	CHK.	APP.	APP.	DATE

# FCAL Insert Design

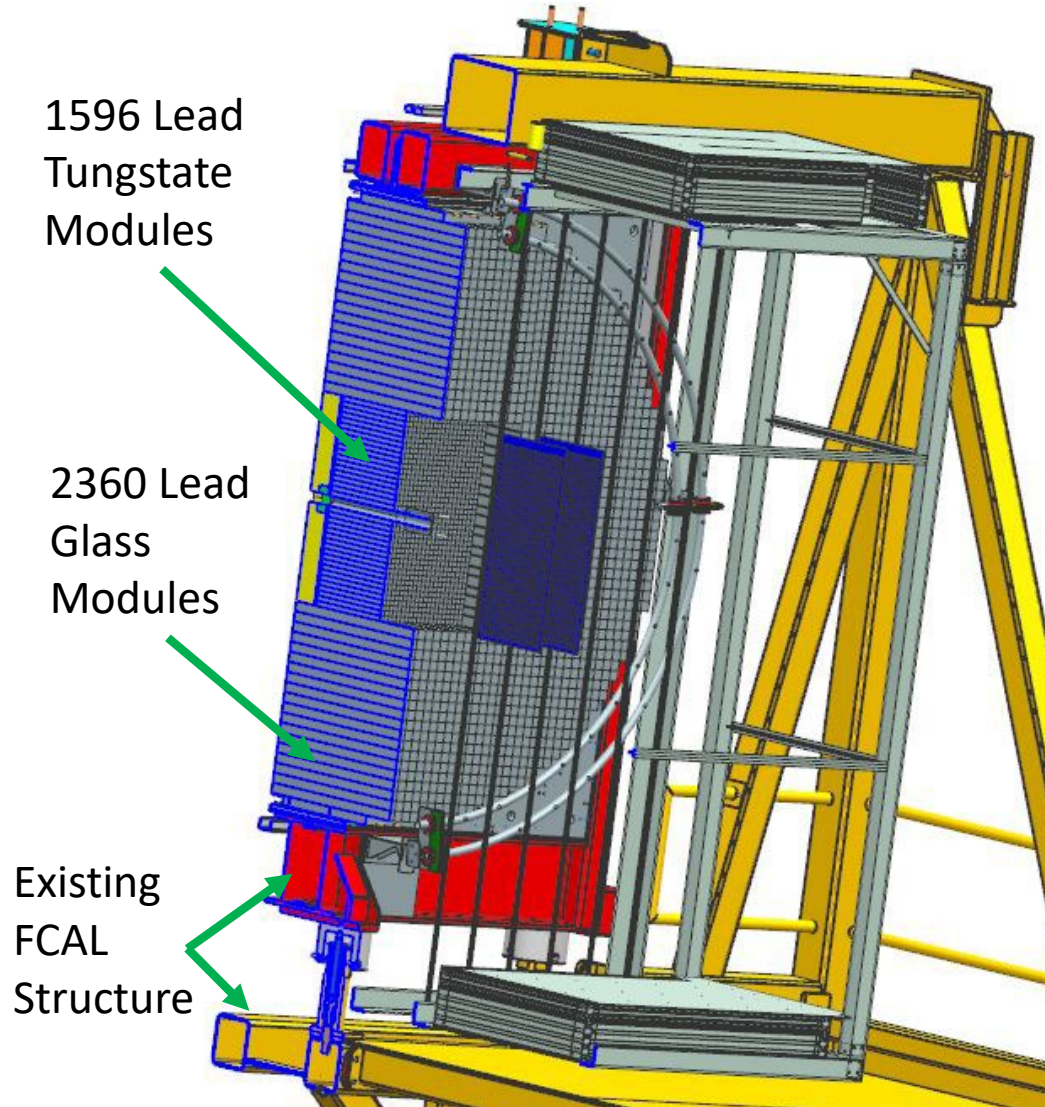

- Borrowed Designer from Engineering – Keith Harding
- 40x40 (2cm) Lead Tungstate Insert
- Design of infrastructure and Modules complete
- Complete set of preliminary drawings have been produced
- All crystal module components on order
- FCAL Darkroom becomes a Refrigerator

Items needing decisions;

- Tungsten absorber size
- Monitoring Panel config.
- PMT Bases – Heat load may be 4KW.

# FCAL Insert Cooling Design

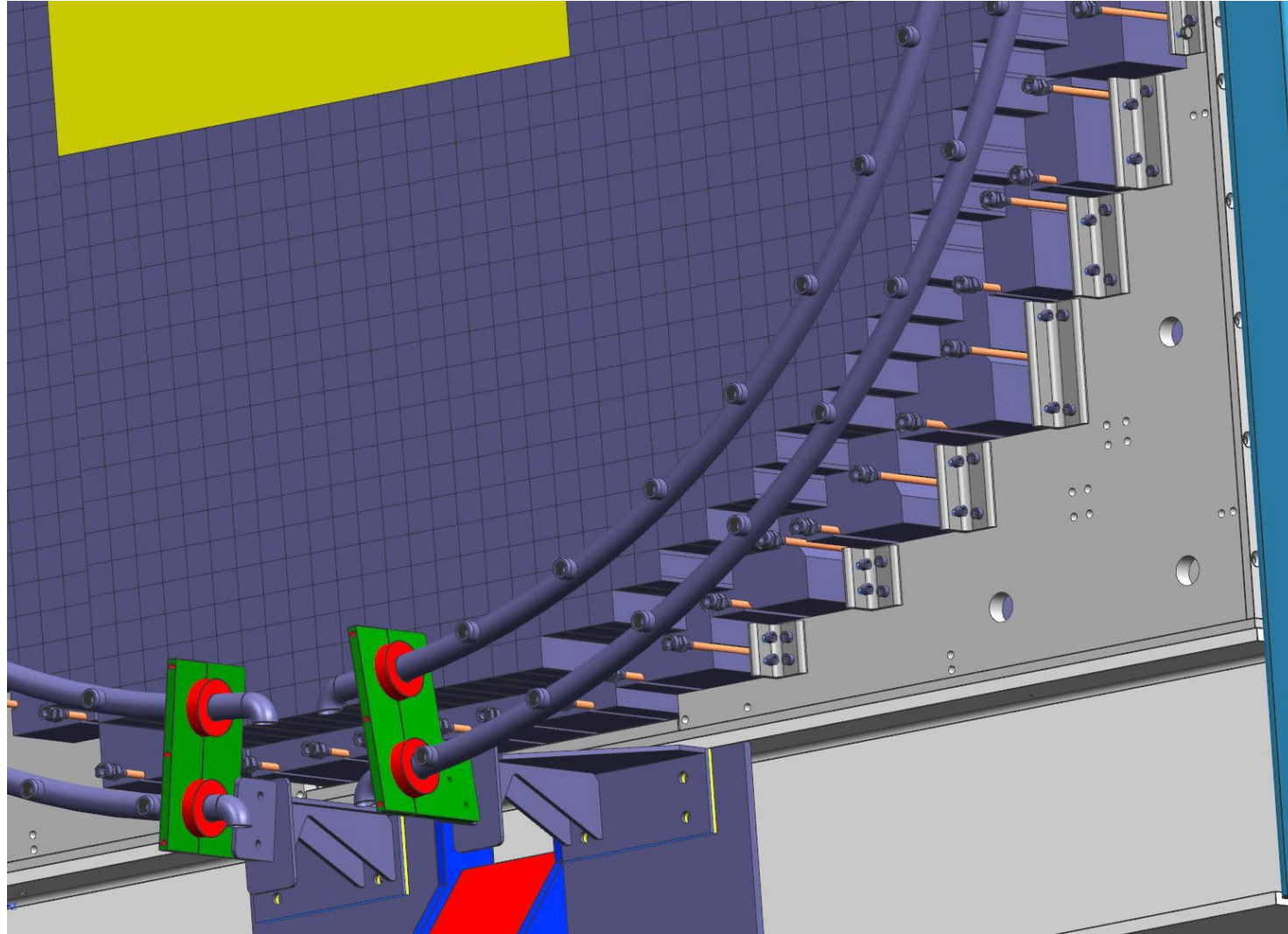

# Required documents

- Aluminum Cooling Block Layout With Dimensions
- D00000-01-06-1201 Lifiable Frame Modifications
- D00000-01-06-0200 FCAL 2 Assembly
- Original Assembly Procedure for FCAL Frame
- D00000-05-00-1021 FCAL Platform assy
- D00000-00-00-1023 FCAL2 Installation
- Table 1 Stack Widths (included in this document)
- Stacking map outlining where blue and green modules go

# Additional Information

- The glass modules are 40.2082mm X 40.0558mm or average of 40.132mm<sup>2</sup> They are stacked alternating larger side up vertical then horizontal. Based on IU info
- The crystal modules are 20.9mm<sup>2</sup> square, measured 40 modules in test set up and came up with the same.
- Measured existing glass vertical height (59 modules) = 2369.15mm (1.37mm higher), yields 40.155mm average
- Measured existing glass horizontal span (59 modules) = 2368.404 (.62 mm wider), yields 40.142mm average. Measured test set up with 21 modules and came up with the same.
- This is small enough to easily be within any available adjustment for x and y

Final Module Arrangement  
2360 Lead-Glass Modules  
1596 Lead Tungstate Modules

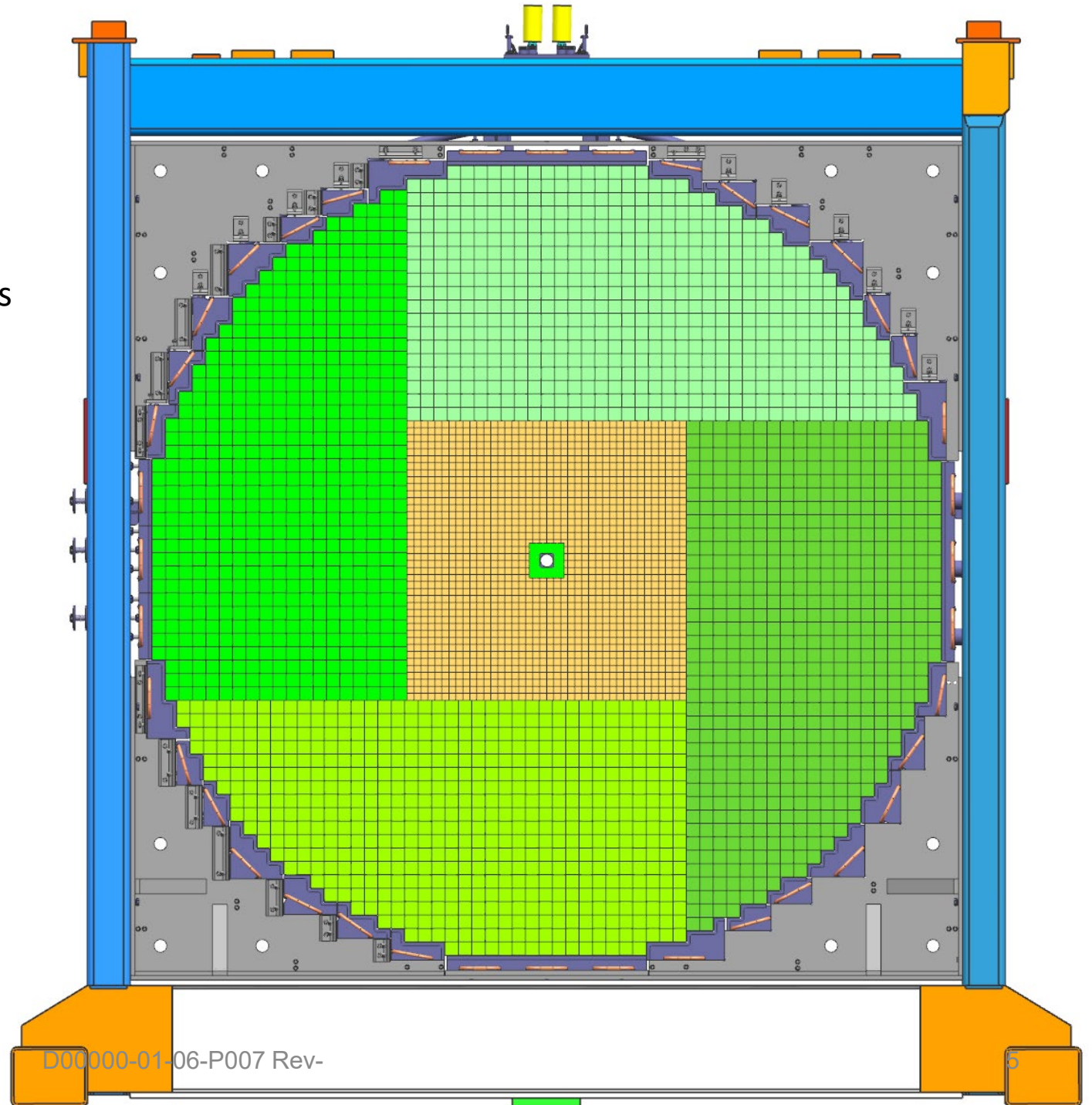

## Initial Preparations

- Before moving the existing FCAL, Survey as found -  
Move platform as far down stream as possible
- Re-survey position for X and Y deltas –
- Remove VESDA piping from Darkroom –
- Remove DS panels, cable labyrinth and 8” side panels from Darkroom
- Remove cabling
- Remove TOF and monitoring panels –
- Categorize all module assemblies –
- Before disassembly of our current FCAL detector, we need to get the best average Vertical and Horizontal Glass Module dimensions.
  - From those dimensions, determine the best shim sizes (vertically and horizontally).
  - Create large printout of the layout to assist in tracking and calculating shims.
  - **Shims (80 um) are to be added under the 1<sup>st</sup> row blocks where the straps are located on the sides.**

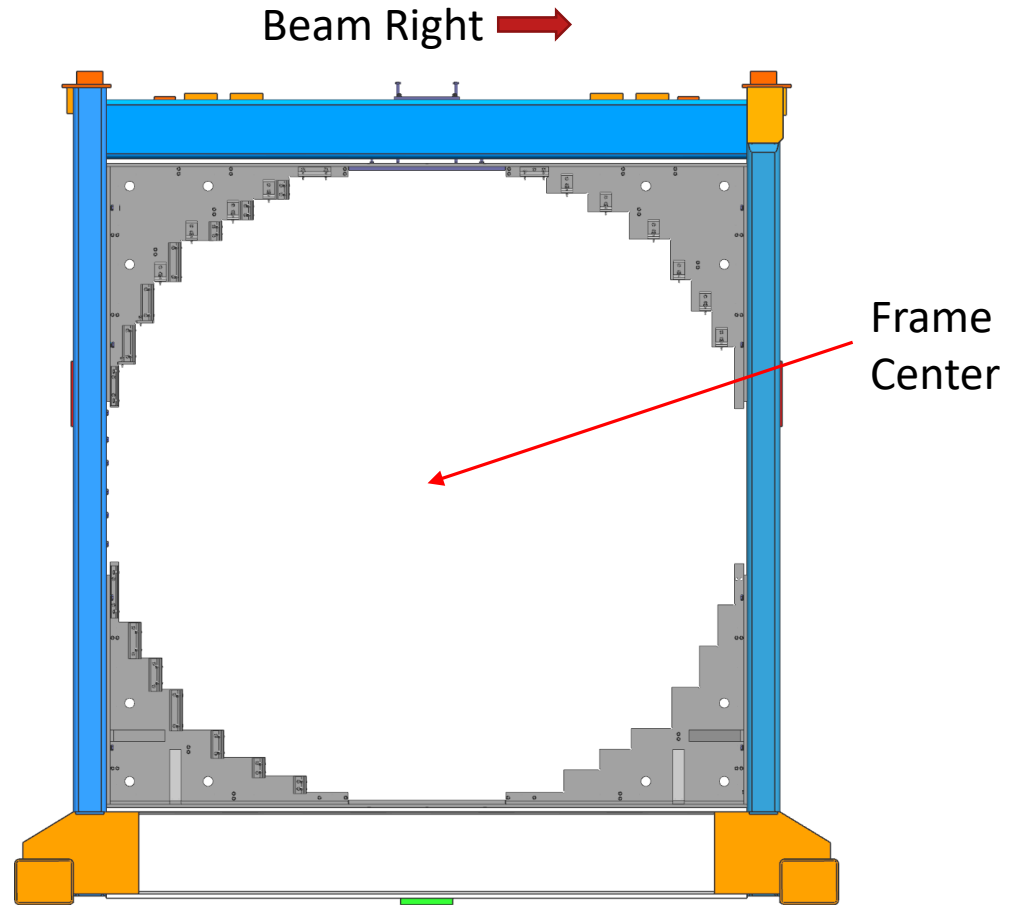

- Remove FCAL Acrylic Light Monitoring System (See dwg D00000-01-06-1214 Plexiglass light monitoring system)
- Unstack all modules and repair as needed
- Remove the liftable frame from the platform and place on floor (See dwg D00000-05-00-1021 FCAL Platform assy)
- Disassemble the frame components in reverse order per “Assembly Procedure for FCAL Frame”
- Modify frame per D00000-01-06-1201
- Assemble FCAL2 frame components per D000000106-0200 with the exception of the Lead glass and crystal modules. Beam right components should be pressed tight against support steps **and pushed all the way downstream**
- Survey the entire assembly and adjust/shim as required to get steps **and the frame square** within 500 um (See layout for baseline dimensions). Tighten all screws on beam right lower blocks to secure in place.
- Fiducialize frame to center on beamline, making allowance for deviations in frame geometry
  - The base plate should be used as the datum defining the X-Z plane
  - The Beam right side plate should be used as the datum defining the Y-Z plane (**secure in place once set**)
  - Mark the centerline on the base plate for horizontal and side plates for vertical based on the fixed beam right side
  - Determine best plane on “Z” for Up-stream face of Glass Bar Modules – will be flush with cooling block supports
- Install the cooling manifold to ensure all components fit
- Remove bottom **beam left** cooling blocks. All upper cooling blocks should be secured in fully retracted position
- Remove the cooling manifold if there will be interference during frame installation.
- Crane frame assy onto platform (D00000-05-00-1021 shows hardware)
- Survey to get the frame in nominal position taking the Z location into consideration and difference in X and Y when platform will be moved into position. Initial center location should be 2.3mm BR and 1mm low as the platform will move BL and up as it moves into final position.



## STAGE 1 Stacking

- At this point, it is undecided whether there will be a thermally conductive silicone pad placed between the BR and BL modules and the cooling plates. If it is decided to use this, it should be placed on every row.
- Install first **Beam Left** Cooling Block with Block fully retracted and **pushed downstream**. **If there are not 40 x 40 crystals**, install shims for vertical alignment that will make top row of tungstate crystals level or above the glass modules on beam right – nominally 7mm offset. Ensure the upstream edges are in the proper Z plane
- Lay the first row of glass bar modules starting tight against the beam right block. Alternate vertical Straps top and bottom) and horizontal (straps on sides) strap orientation as shown on layout. The first module is to be vertical. Place an 80 um SS shim under each horizontal module.
- The orientation of the base from the Downstream (DS) end should look like the picture to the right (for all modules!).
- Using a straight edge across the top of the first row, Ensure the top of the glass modules are within **300 microns (.012 inch)** of each other and the next step on the cooling blocks.
- Use a straight edge across the upstream face of the module to ensure they are in the same Z plane and flush **with the upstream edge** of cooling blocks
- Carefully snug the set screws evenly **finger tight** on beam left to force the first row of modules to beam right. **Torque all screws evenly in 1 inch-lb increments to achieve the row width according to table 1**. Record the screw torque and displacement of the row of modules. **The rows width should equal those in the table 1 +/- 1mm.**

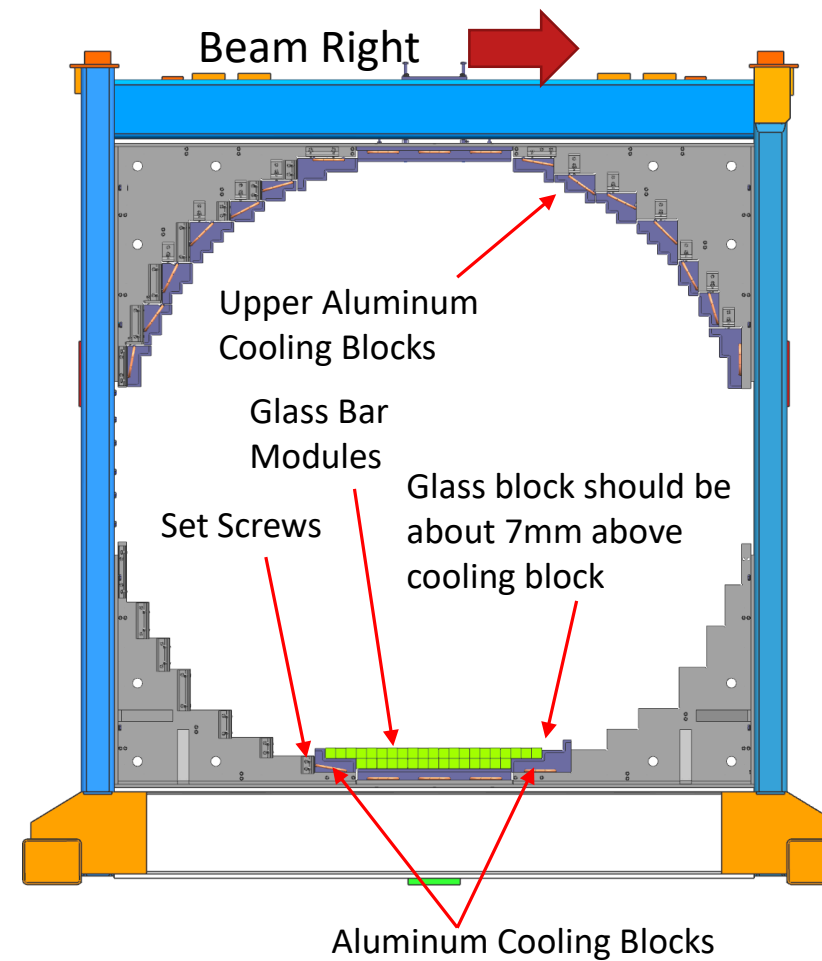

Module Base Orientation – typical for all modules

## STAGE 1 Stacking con't

- Loosen the set screws to make enough room to be able to install the 2<sup>nd</sup> row
- Lay in the 2<sup>nd</sup> row of Glass Bar Modules (alternating each 90° along BL axis). **Always ensure the module above is rotated 90° from the one below. The PMT base should always be oriented the same regardless of module orientation.**
- **Place and 80 um shim under the horizontal modules that are against the cooling blocks only.**
- Ensure the upstream face of the modules are aligned in the same Z position flush with the **upstream edge** of cooling blocks.
- The module will stick up over the beam right cooling block step by 7 mm. This is as designed
- Tighten these rows to Beam Right (Think Pre-Loading) **finger tight then 1 in-lb increments to achieve the nominal dimension on table 1. They must be tightened evenly for all four screws.**
- Check the position of the Glass Bar Modules to verify correct positioning in X, ie. Center lines up with center mark. Re-shim on beam right for horizontal alignment if needed
- **Back off screws on the BL cooling block to Release pressure (Do NOT allow Modules to move)**

Beam Right



80 um shim under horizontal modules against aluminum cooling blocks only

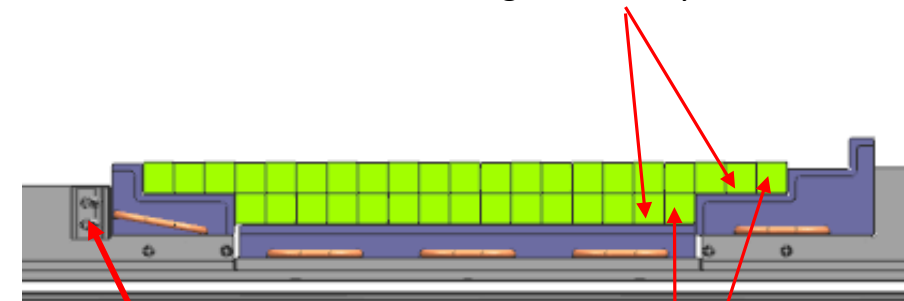

These blocks should have the SS straps on top and bottom (vertical)

Compression (set) screws

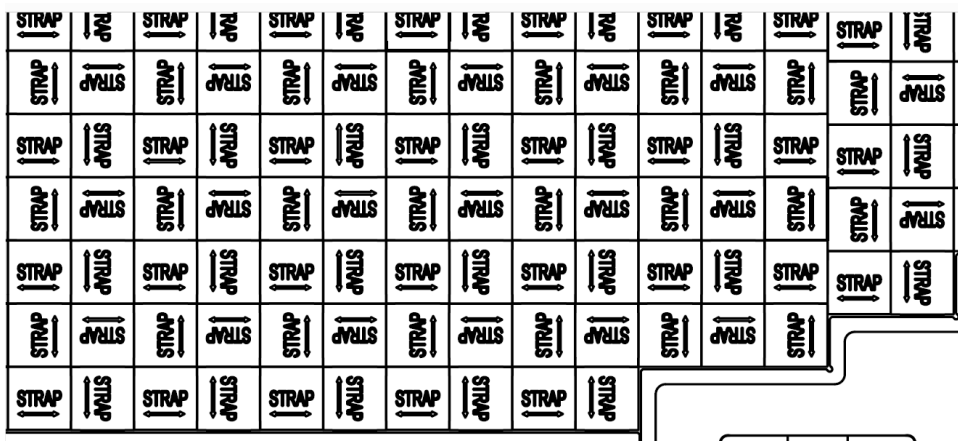

Arrows point towards location of straps



D00000-01-06-P007 Rev-

## STAGE 2

- Install next layer of BL Cooling Block with Block fully retracted and pushed downstream
- Starting from beam right, Lay in the next two rows of Glass Bar Modules from beam right side (alternating each 90° along BL axis). If the 1<sup>st</sup> 2 blocks of the 3<sup>rd</sup> row do not fit, re-shim the 1<sup>st</sup> 2 rows on the beam right side to accommodate.
- Shim (80 um) under the horizontal modules over cooling blocks beam right and beam left.
- Tighten these all rows to Beam Right (Think Pre-Loading)
- Check the position of the Glass Bar Modules to verify correct positioning. The beam right modules should be 7mm (.275 in) below other blocks.
- Check nominal width of rows to table 1 and shim either BL of BR to ensure the rows are tight
- Apply a straight edge to the top of the row and check to make sure there is no gap greater than a 300 um (.012") offset in any block or cooling plate. Shim if needed. **This step can be implemented for every row. Shim if needed.**
- Release pressure (Do NOT allow Modules to move)
- Retighten Stage 1 Cooling Blocks (**Apply penetrating loctite to 4 screws, you may hold off until further rows are installed**)

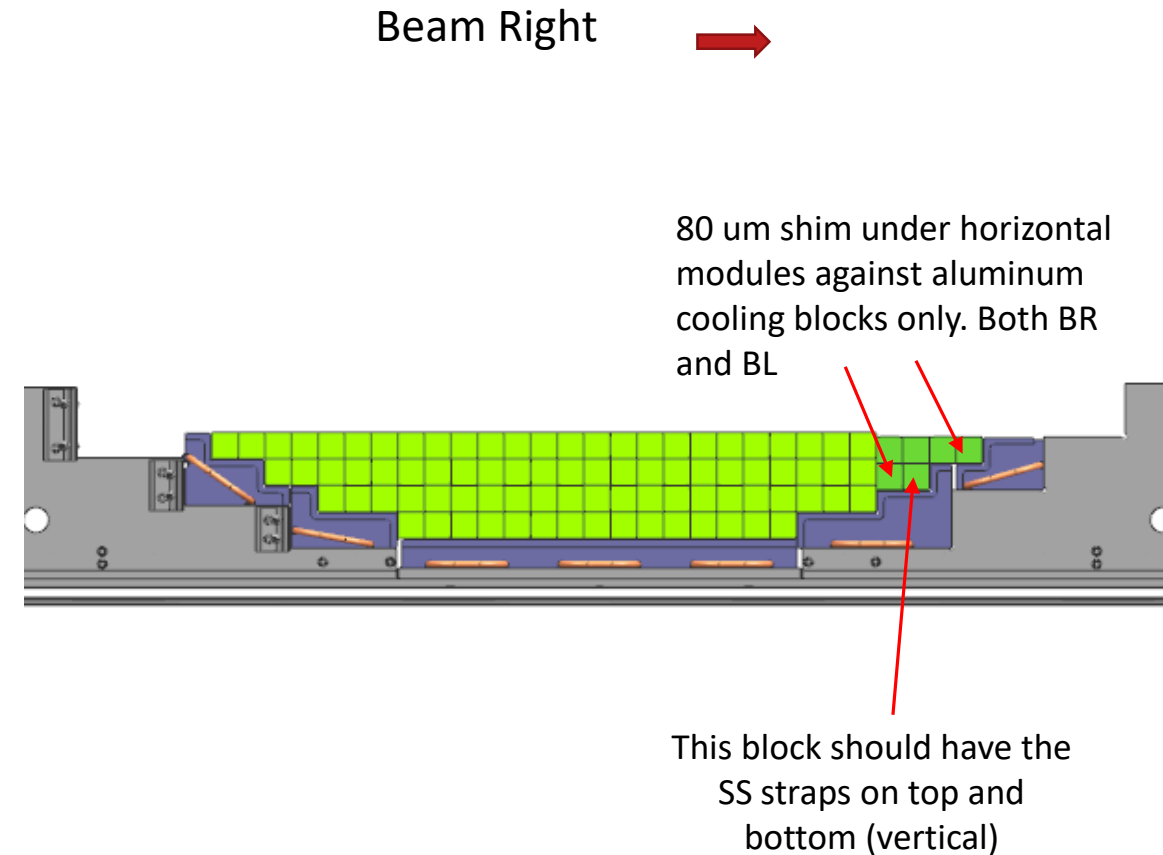

### STAGE 3

- Install next set of Cooling Blocks with Blocks fully retracted and fully Down Stream (DS)
- Lay in the next two rows of Glass Bar Modules using calculated shims (alternating each 90° along BL axis)
- Tighten these rows to Beam Right (Think Pre-Loading) as described earlier.
- Check the position of the Glass Bar Modules to verify correct positioning
- Ensure the vertical delineation line is straight and vertical and located properly in X (**within  $\pm 0.5$  mm**). If too far out, the subsequent rows may need to be shifted)
- Release pressure (Do NOT allow Modules to move)
- Retighten Stage 2 Cooling Blocks
- Apply a straight edge to the top of the row and check to make sure there is no gap greater than a 250  $\mu$ m (.010") offset in any block. **This step can be implemented for every row. Shim if needed.**
- Use Survey optical tool to verify if needed
- Survey frame fiducials to ensure the assembly is still in proper position. Adjust if needed.

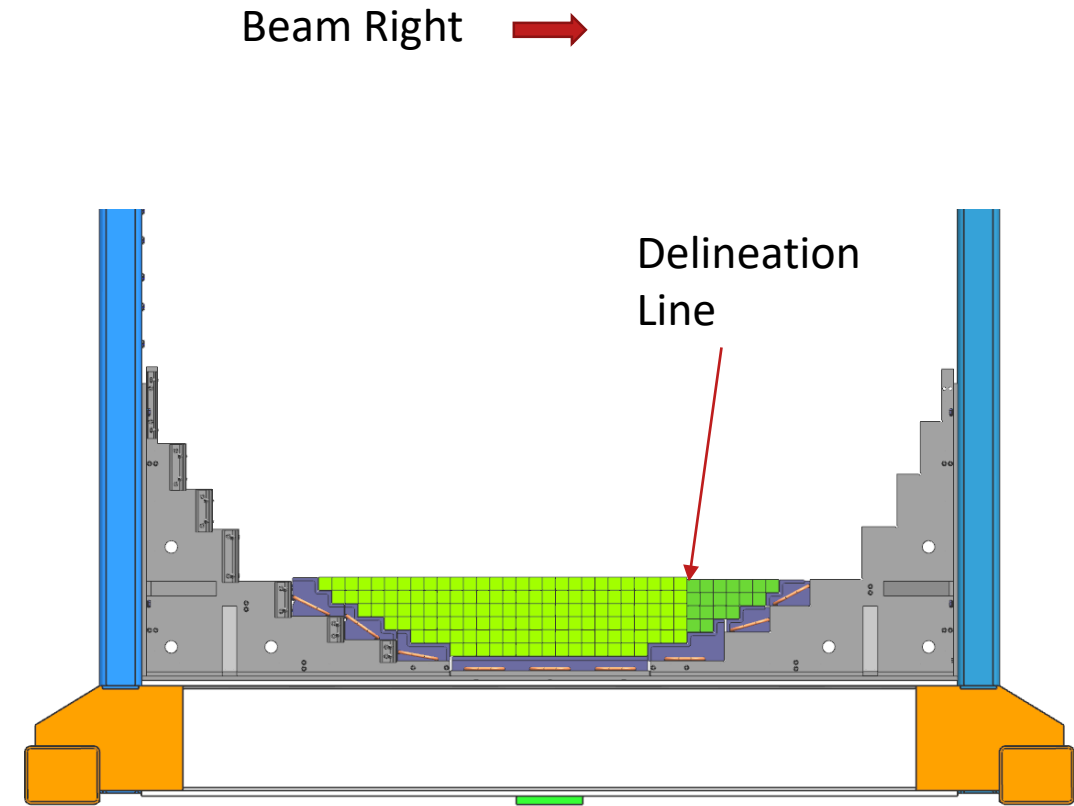

## STAGE 4

- Install Cooling Blocks with Blocks fully retracted
- Lay in the next four rows of Glass Bar Modules (alternating each 90° along BL axis).
- Shim (80  $\mu$ m) under horizontal modules on top of cooling blocks
- Tighten these rows to Beam Right (Think Pre-Loading)
- Check the position of the Glass Bar Modules to verify correct positioning
- Ensure the vertical delineation line is straight and located properly in X. If too far out, the subsequent rows may need to be shifted)
- Ensure all is straight and level
- Shim if required
- Release pressure (Do NOT allow Modules to move)
- Retighten Stage 3 Cooling Blocks

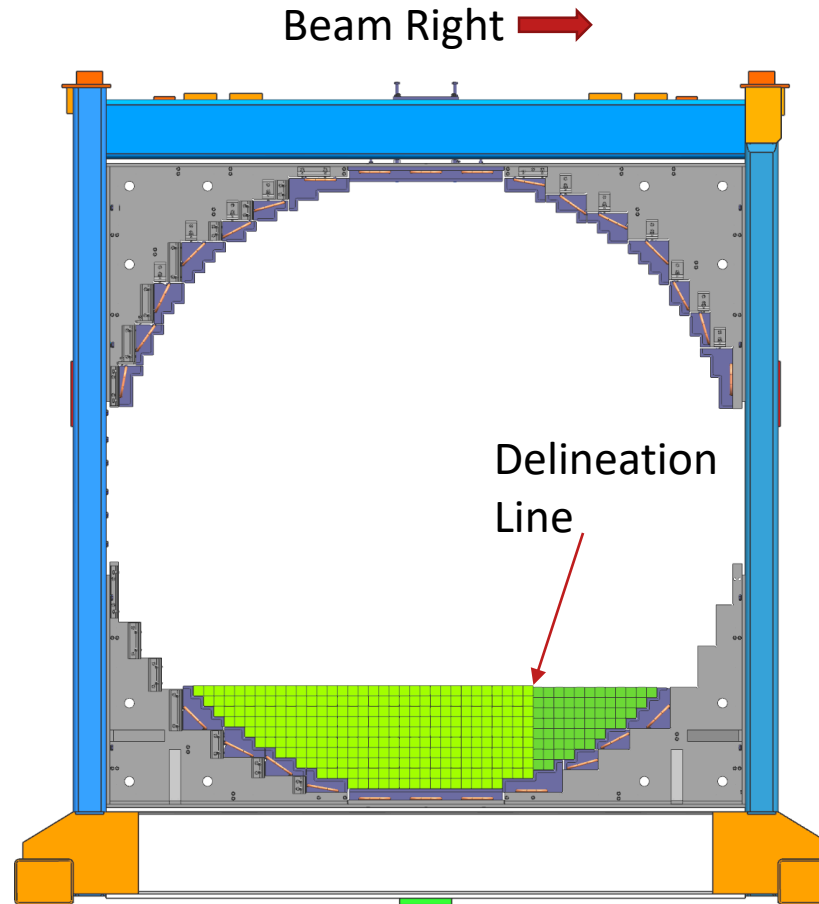

## STAGE 5

- Install Cooling Blocks with Blocks fully retracted
- Lay in the next four rows of Glass Bar Modules (alternating each 90° along BL axis).
- Shim (80  $\mu$ m) under horizontal modules on top of cooling blocks
- Tighten these rows to Beam Right (Think Pre-Loading)
- Check the position of the Glass Bar Modules to verify correct positioning
- Ensure the vertical delineation line is straight and located properly in X. If too far out, the subsequent rows may need to be shifted)
- Ensure all is straight and level
- Shim if required
- Release pressure (Do NOT allow Modules to move)
- Retighten Stage 4 Cooling Blocks

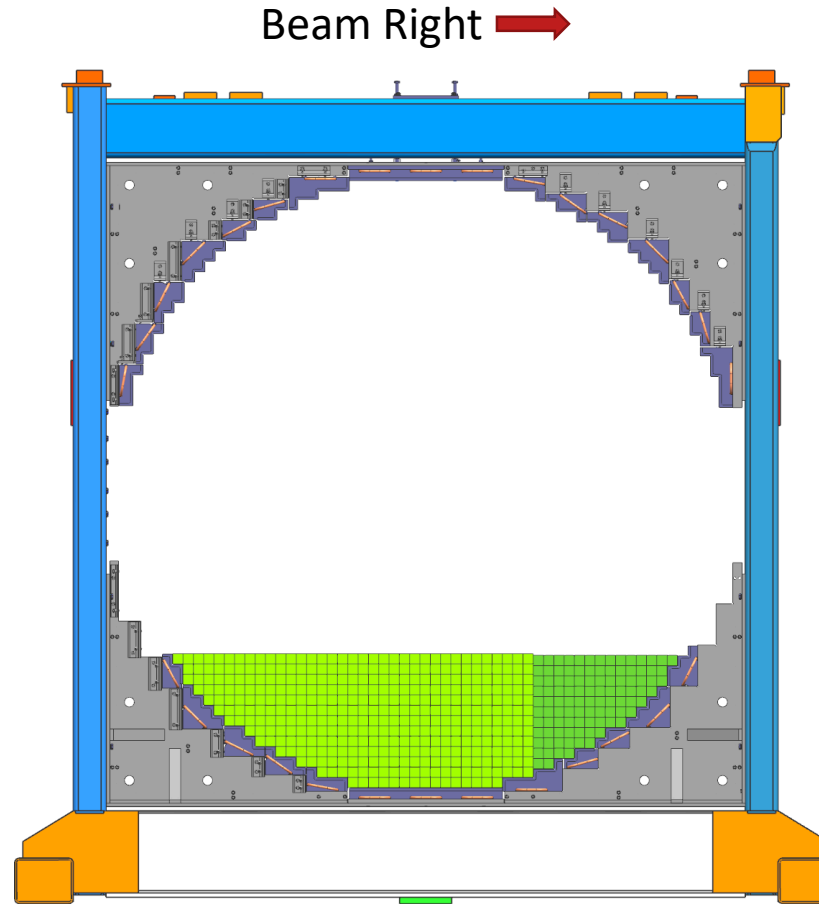

## STAGE 6

- Install Cooling Blocks with Blocks fully retracted
- Lay in the next four rows of Glass Bar Modules (alternating each 90° along BL axis).
- Shim (80  $\mu$ m) under horizontal modules on top of cooling blocks
- Tighten these rows to Beam Right (Think Pre-Loading)
- Check the position of the Glass Bar Modules to verify correct positioning
- Ensure the vertical delineation line is straight and located properly in X. If too far out, the subsequent rows may need to be shifted)
- Ensure all is straight and level
- Shim if required
- Release pressure (Do NOT allow Modules to move)
- Retighten Stage 5 Cooling Blocks

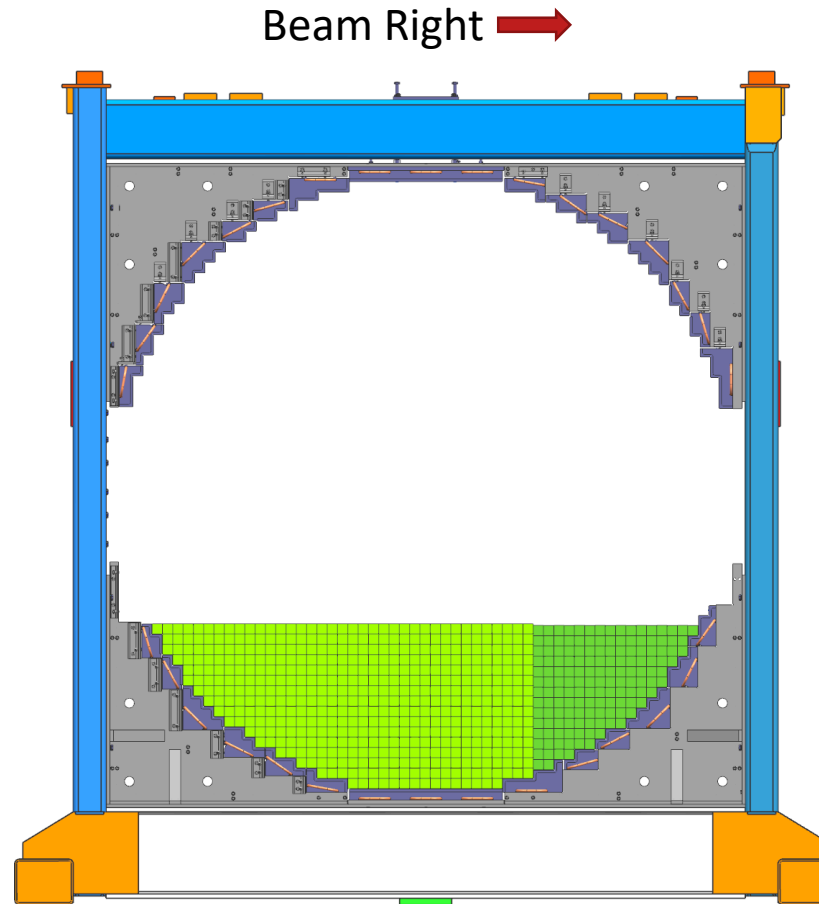

## STAGE 7A

- Install Cooling Blocks with Blocks fully retracted
- Lay in the next three rows of Glass Bar Modules (alternating each 90° along BL axis)
- Tighten these rows to Beam Right (Think Pre-Loading)
- Check the position of the Glass Bar Modules to verify correct positioning (CRITICAL that the tops of Modules be level and straight for this stage)  
**Nominally we will need 160 um shims on every other glass block where crystals will go – maybe a thin aluminum sheet to cover all glass modules? 160 um thick? Shim as needed to yield a flat surface where crystals will go.**
- Get survey and Alignment group to shoot the top row and frame fiducials. Adjust the liftable frame cartridges as needed to bring within +/- 0.5mm.
- Determine the vertical height of the first 19 rows to determine if there will need to be a shim between the lead glass and 1<sup>st</sup> crystal row
- Re-tighten stage 6
- Release pressure (Do NOT allow Modules to move)

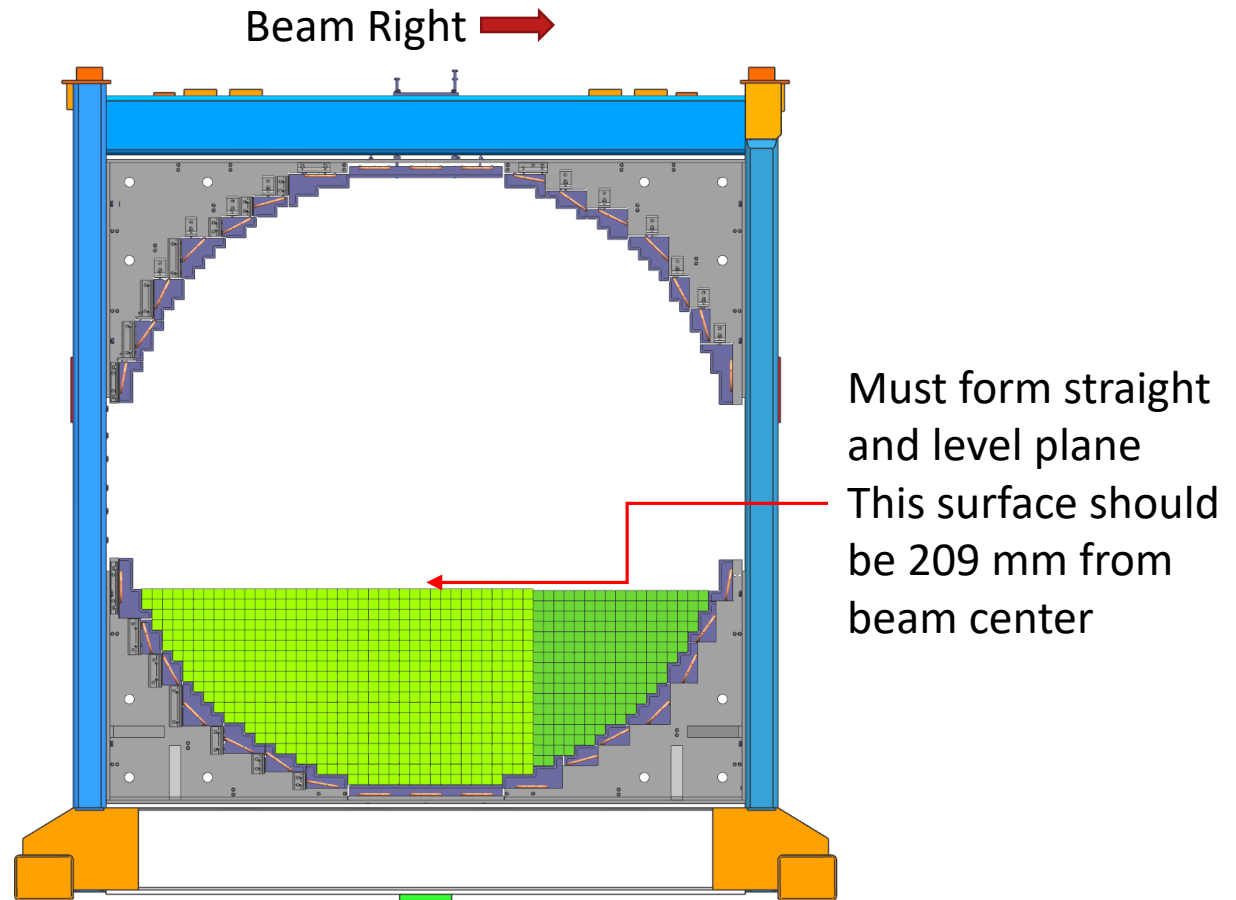



## STAGE 7B & 7C

- Lay in the next three rows (or 1 row at a time) of Glass Bar Modules using calculated shims starting from Beam Right (alternating each 90° along BL axis)
- Install a thin (160 um?) SS sheet on top of the glass modules where crystals and beam left glass modules go
- Compress these rows using plastic Pusher Block, Small
- Validate these rows form a straight and plumb plane (Shim Beam Right as necessary)
- Install a thermally conductive silicone pad (ThermaCool R10404 1/32") against the vertical edge of the glass modules
- Install 5 rows of 40 Lead Tungstate Crystals (maybe only 2) with Up-Beam faces 125mm Down-beam of Glass Bar Module faces always pushing tight to beam right. We may wish to install fewer rows at first to determine how they react to squeezing.
- Install a thermally conductive silicone pad against the vertical edge of the crystal modules. Compress to beam right.
- Install remaining 3 rows of 18 glass Bar Modules. Nominally, a 160um shim will be needed on the beam left side of every other glass module.
- Tighten these rows to Beam Right (Think Pre-Loading)
- Check the position of the Glass Bar Modules and Crystals to verify correct positioning
- The top of the crystals should be Below BR and Below BL modules

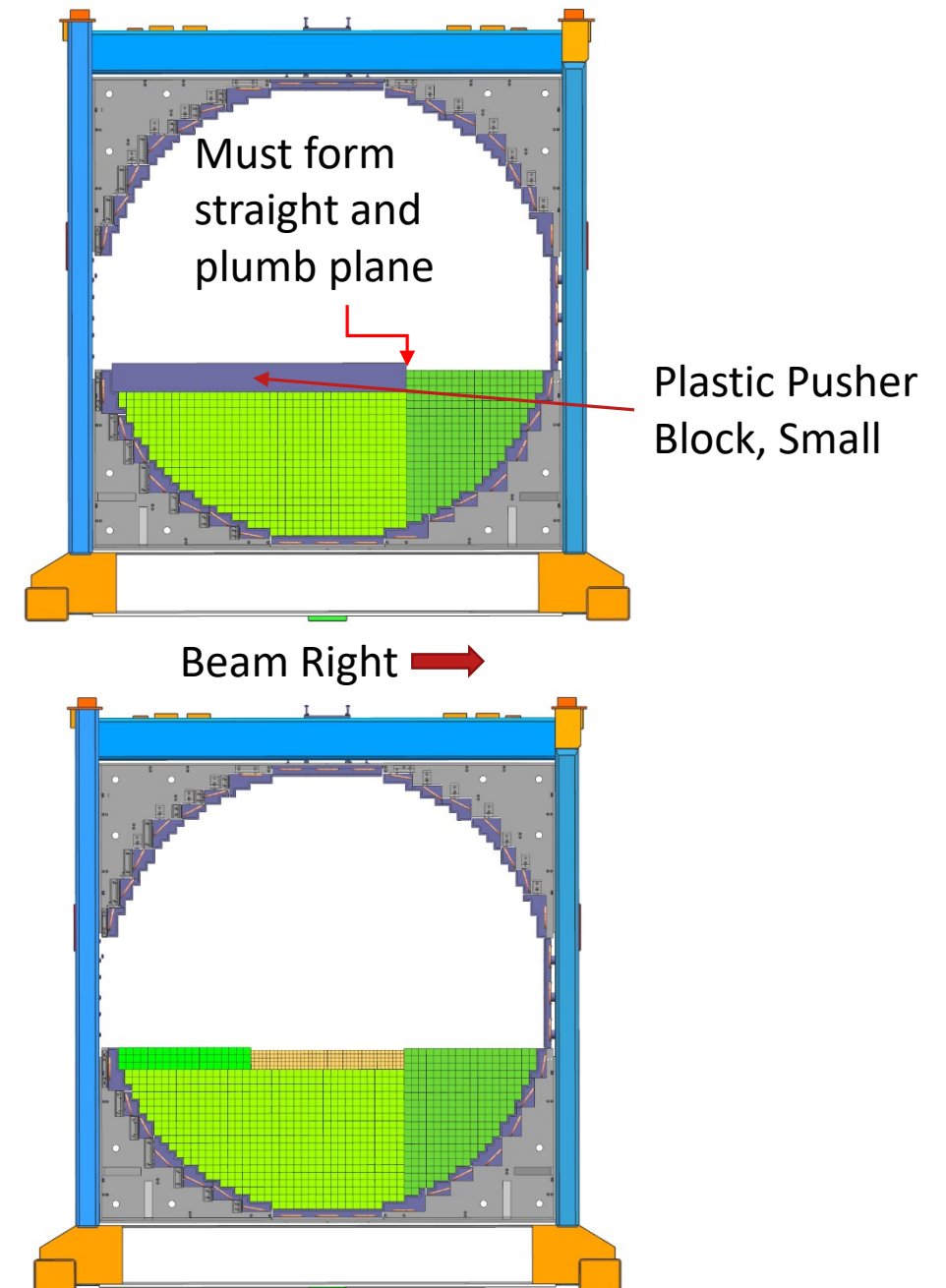

## STAGE 7D & 7E

- Install bottom Beam Left Compression plate and Compression Plate, Beam Right
- Lay in the next **five** rows (or 1 row at a time) of Glass Bar Modules using calculated shims starting from Beam Right (alternating each 90° along BL axis)
- **Compress these rows using plastic Pusher Block, Medium**
- Validate these rows form a straight and plumb plane (Shim Beam Right as necessary)
- **Install a thermally conductive silicone pad against the vertical edge of the glass modules**
- Install **5** rows of 40 Lead Tungstate Crystals (maybe only **2 at a time**) with Up-Beam faces 125mm Down-beam of Glass Bar Module faces always pushing tight to beam right may wish to install fewer rows at first to determine how they react to squeezing.
- **Install a thermally conductive silicone pad against the vertical edge of the crystal modules**
- Install remaining **5** rows of 18 glass Bar Modules. **Nominally, a 160um shim will be needed on the beam left side of every other glass module.**
- Tighten these rows to Beam Right (Think Pre-Loading)
- Check the position of the Glass Bar Modules and Crystals to verify correct positioning (CRITICAL that the tops of Modules and Crystals be level and straight for this stage)
- The top of the crystals should be Below BR and Below BL modules

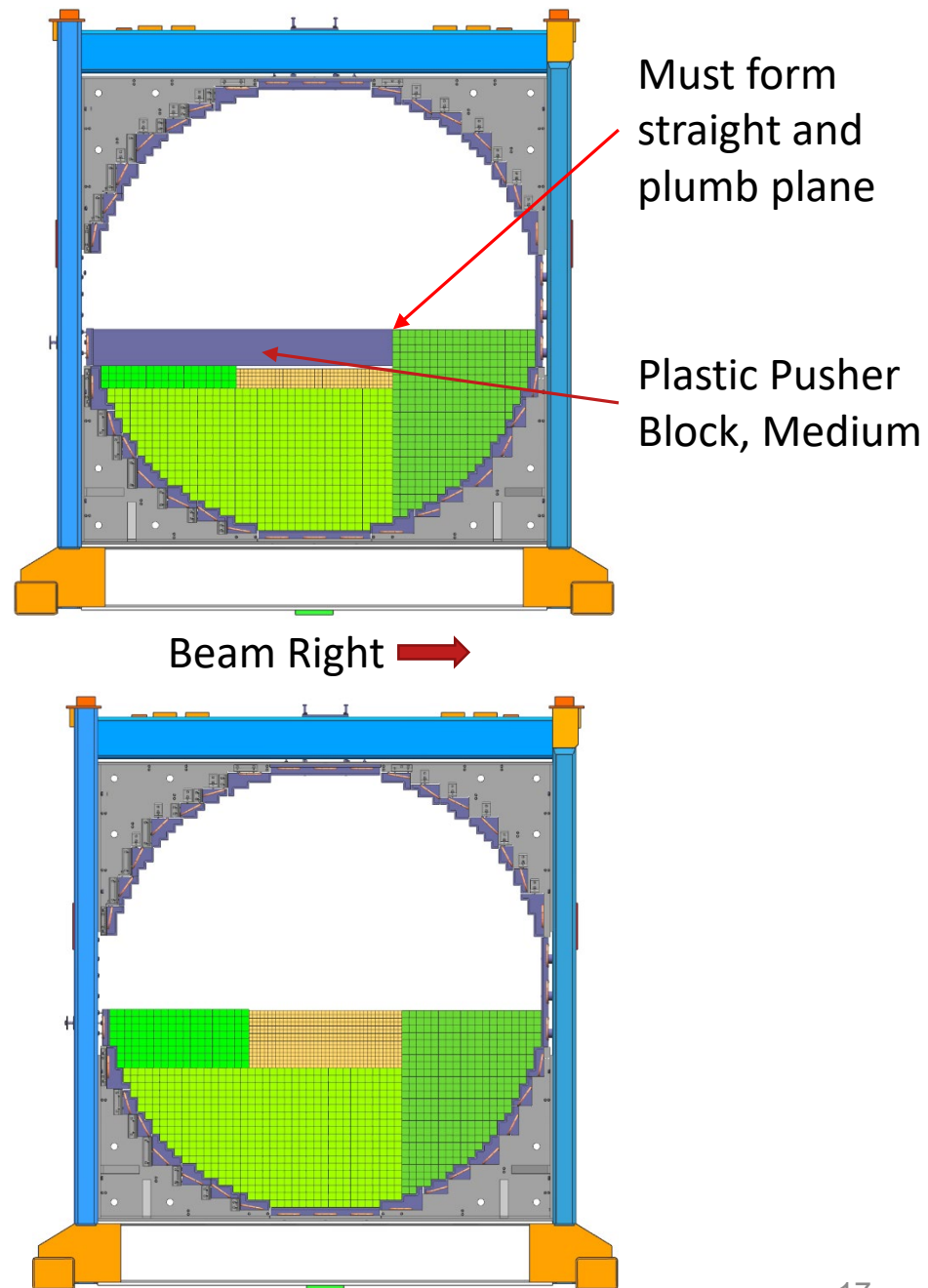

## STAGE 8 & 8A

- Install **middle Compression Plate, Beam Left**
- Lay in the next 5 rows of 19 Glass Bar Modules using calculated shims starting from Beam Right (alternating each 90° along BL axis)
- **Compress glass modules to BR using plastic Pusher Block, Medium**
- Validate these rows form a straight and plumb plane (Shim Beam Right as necessary)
- **Install thermally conductive rubber against vertical edge of glass modules**
- Install 4 rows of 40 Lead Tungstate Crystals with Up-stream faces 125mm Down-stream of Glass Bar Module faces (**may be done in fewer rows at a time to compress**)
- Install 2 rows of 19 Lead Tungstate Crystals then the Beam Tube then the remaining 2 rows of 19 Crystals. Shims may be needed under beam tube to give a flat surface. **Beam Tube should protrude XX mm upstream of the crystal faces**
- **Install thermally conductive rubber against vertical edge of crystal modules**
- Install remaining 5 rows of 19 glass Bar Modules
- Tighten these rows to Beam Right (Think Pre-Loading)
- Check the position of the Glass Bar Modules and Crystals to verify correct positioning (CRITICAL that the tops of Modules and Crystals be level and straight for this stage)
- **Ensure BR step height is 13.34mm To see if future rows may need to be shimmed.**
- Release pressure (Do NOT allow Modules to move)
- Retighten Stage 7 Cooling Blocks
- **Survey to determine center tube location and add to fiducialization**

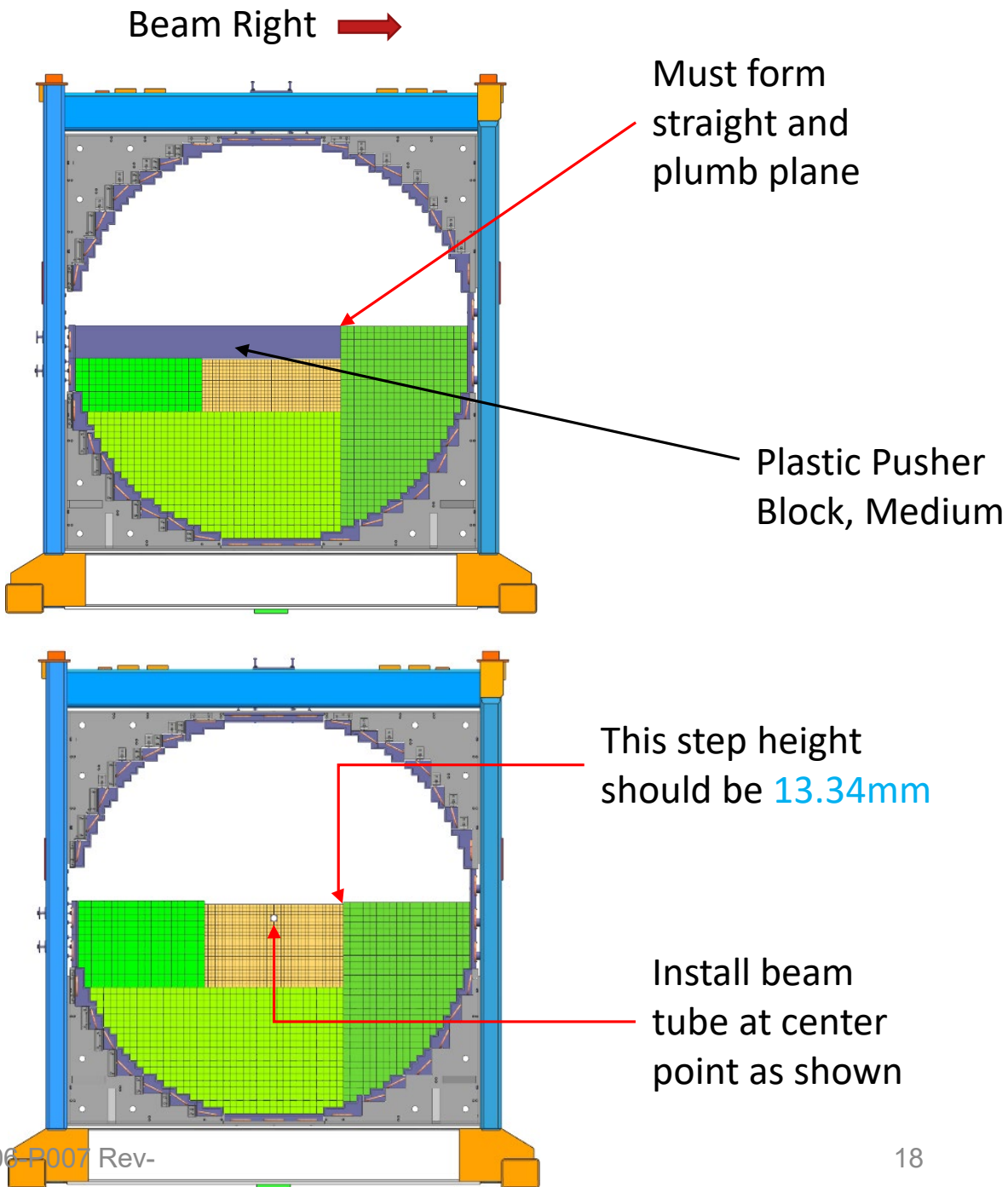

## STAGE 9 & 9A

- Install top Compression Plate, Beam Left
- Lay in the next 5 rows of 19 Glass Bar Modules using calculated shims starting from Beam Right (alternating each 90° along BL axis).
- Compress using plastic Pusher Block, Medium, to beam right
- Install thermally conductive rubber against the vertical edge of glass modules
- Validate these rows form a straight and plumb plane (Shim Beam Right as necessary)
- Install 10 rows of 40 Lead Tungstate Crystals with Up-Beam faces 125mm Down-beam of Glass Bar Module faces
- Install thermally conductive rubber against the vertical edge of crystal modules
- Install remaining 5 rows of 19 glass Bar Modules
- Tighten these rows to Beam Right (Think Pre-Loading)
- Check the position of the Glass Bar Modules and Crystals to verify correct positioning (CRITICAL that the tops of Modules and Crystals be level and straight for this stage)
- Release pressure (Do NOT allow Modules to move)

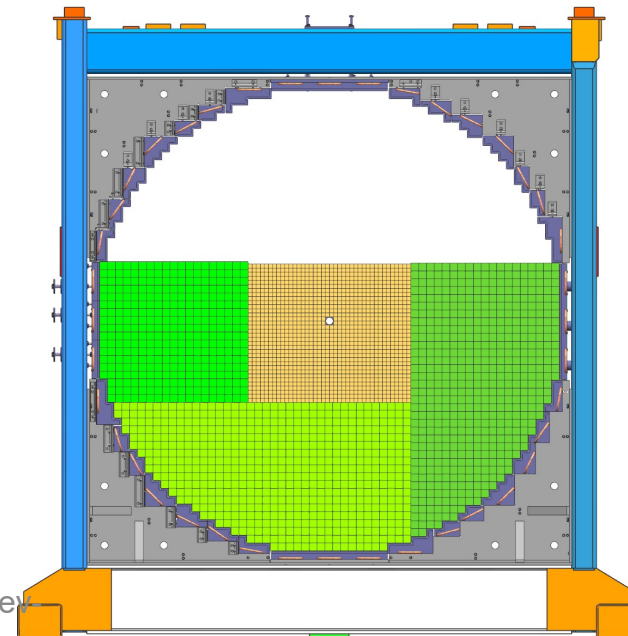
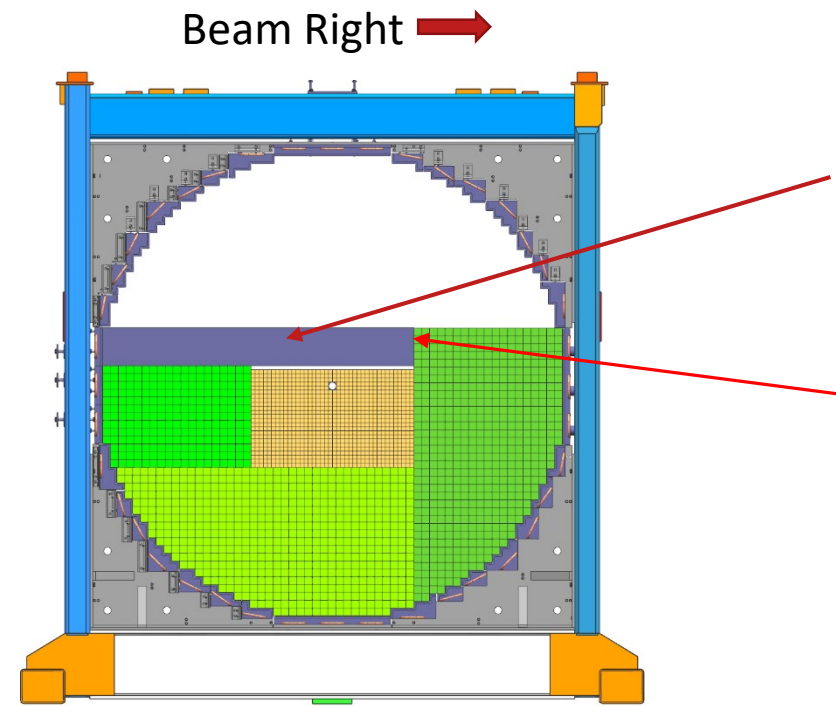

## STAGE 10

- Lower BR cooling block until there is still enough room to install the next 3 rows of modules. Ensure it is pushed all the way BR
- Lay in the next 3 rows of 19 Glass Bar Modules using calculated shims starting from Beam Right (alternating each 90° along BL axis)
- Tighten these rows beam right using pusher block
- Validate these rows form a straight and plumb plane (Shim Beam Right as necessary)
- Install 6 rows of 40 Lead Tungstate Crystals with Up-Beam faces 125mm Down-beam of Glass Bar Module faces
- Install next 3 rows of 19 glass Bar Modules
- Tighten these rows to Beam Right (Think Pre-Loading)
- Check the position of the Glass Bar Modules and Lead Crystals to verify correct positioning (CRITICAL that the tops of Modules and Crystals be level and straight for this stage)
- If the beam right Lead Glass Modules do not align with the top of the Crystals, shim as required on top of Glass Modules to make these flush
- Release pressure (Do NOT allow Modules to move)

Pusher Block

Beam Right →

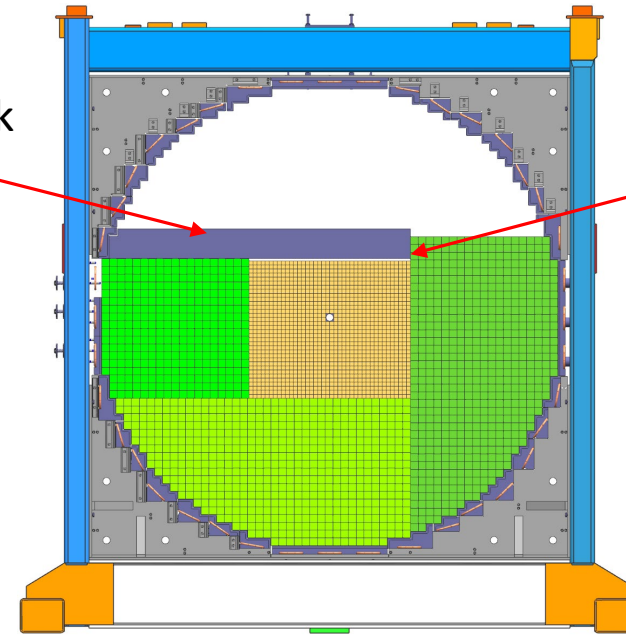

Must form straight and plumb plane

Must form straight and level plane, maybe a thin alum sheet to spread load?

Shim as necessary here

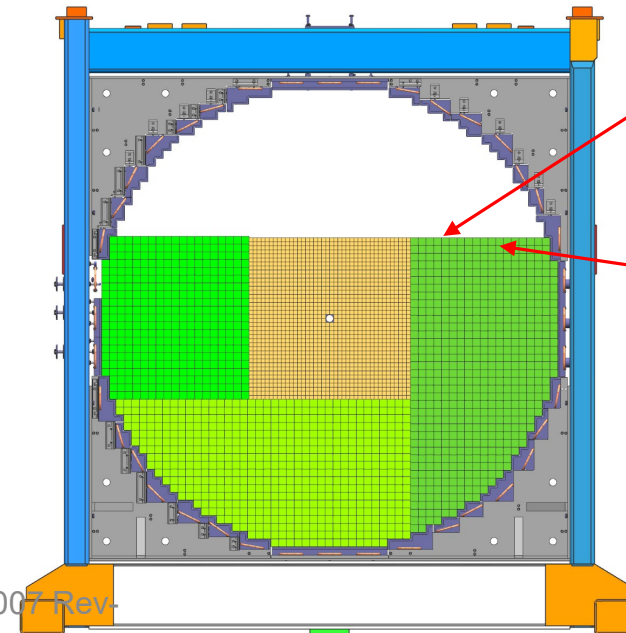

## STAGE 10A

- Install next FULL row of Glass Bar Modules
- Tighten row again and recheck positions of Glass Bar Modules (Straight and level). Shim if needed
- Release pressure (Do NOT allow Modules to move)
- Retighten Stage 8 & 9 Cooling Blocks

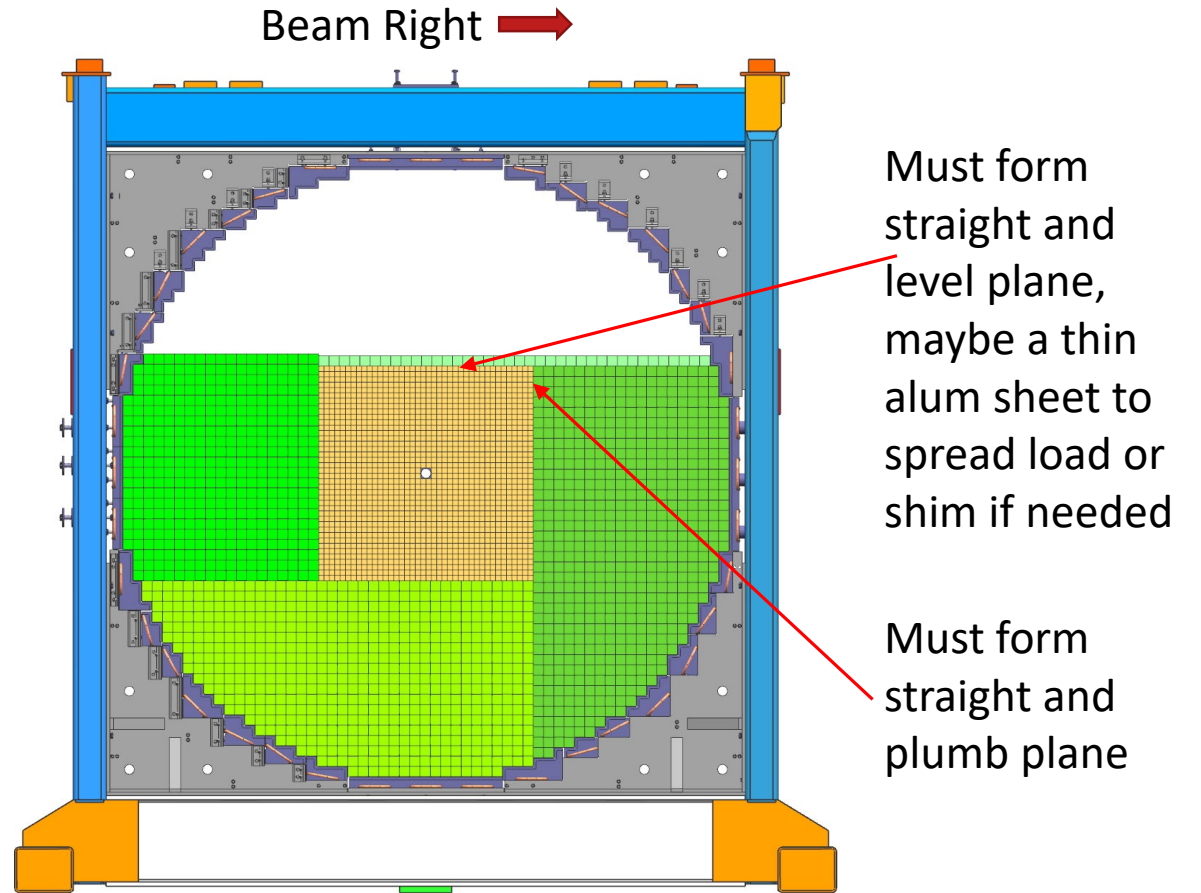

## STAGE 11

- Lower BR cooling block until there is still enough room to install the next 4 rows of modules
- Lay in the next four rows of Glass Bar Modules using calculated shims (alternating each 90° along BL axis)
- Tighten these rows to Beam Right (Think Pre-Loading)
- Check the position of the Glass Bar Modules to verify correct positioning
- Release pressure (Do NOT allow Modules to move)
- Retighten Stage 10 Cooling Blocks

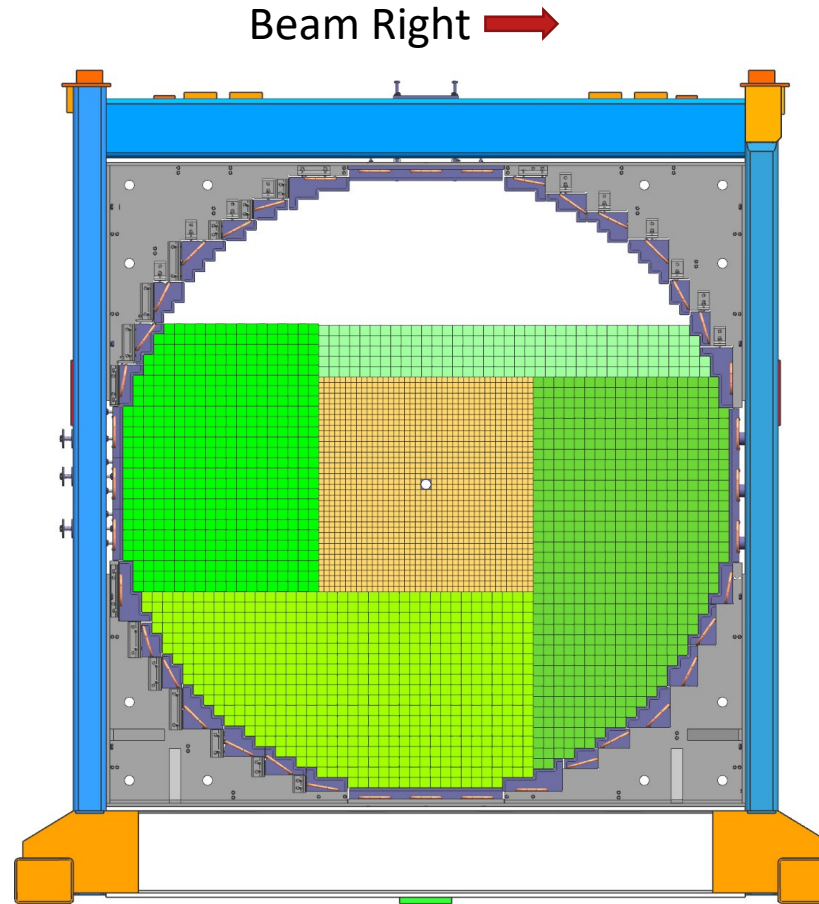

## STAGE 12

- Ensure Cooling Blocks are fully retracted both vertically and horizontally
- Lay in the next four rows of Glass Bar Modules using calculated shims (alternating each 90° along BL axis)
- Tighten these rows to Beam Right (Think Pre-Loading)
- Check the position of the Glass Bar Modules to verify correct positioning
- Release pressure (Do NOT allow Modules to move)
- Retighten Stage 11 Cooling Blocks

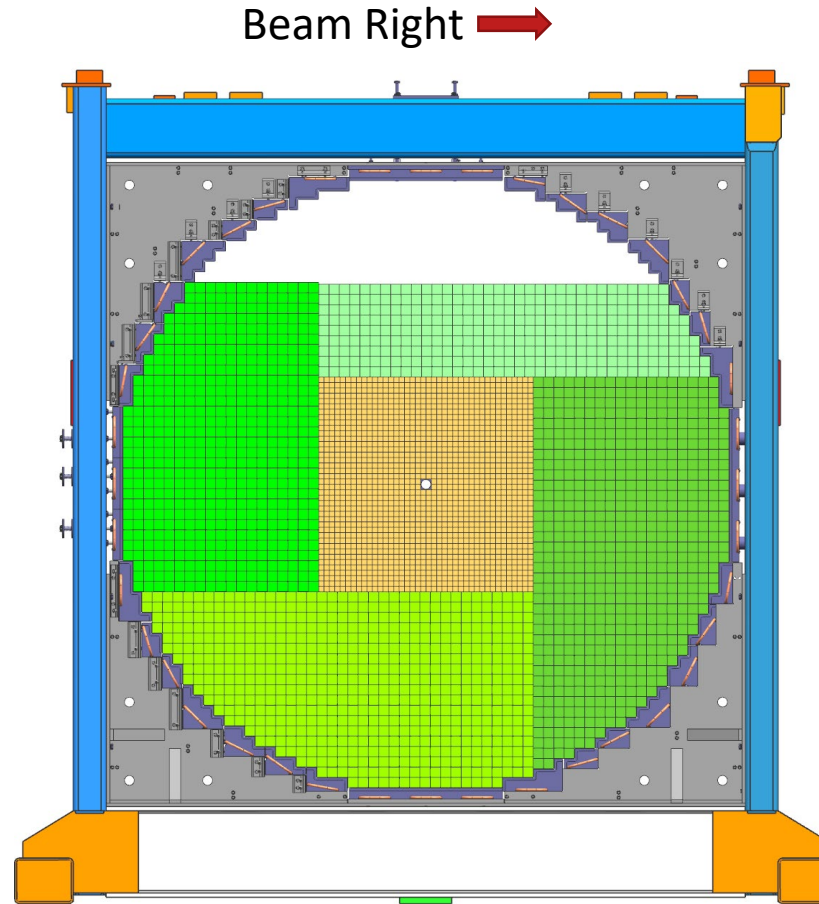



### STAGE 13

- Ensure Cooling Blocks are fully retracted both vertically and horizontally
- Lay in the next four rows of Glass Bar Modules using calculated shims (alternating each 90° along BL axis)
- Tighten these rows to Beam Right (Think Pre-Loading)
- Check the position of the Glass Bar Modules to verify correct positioning
- Release pressure (Do NOT allow Modules to move)
- Retighten Stage 12 Cooling Blocks

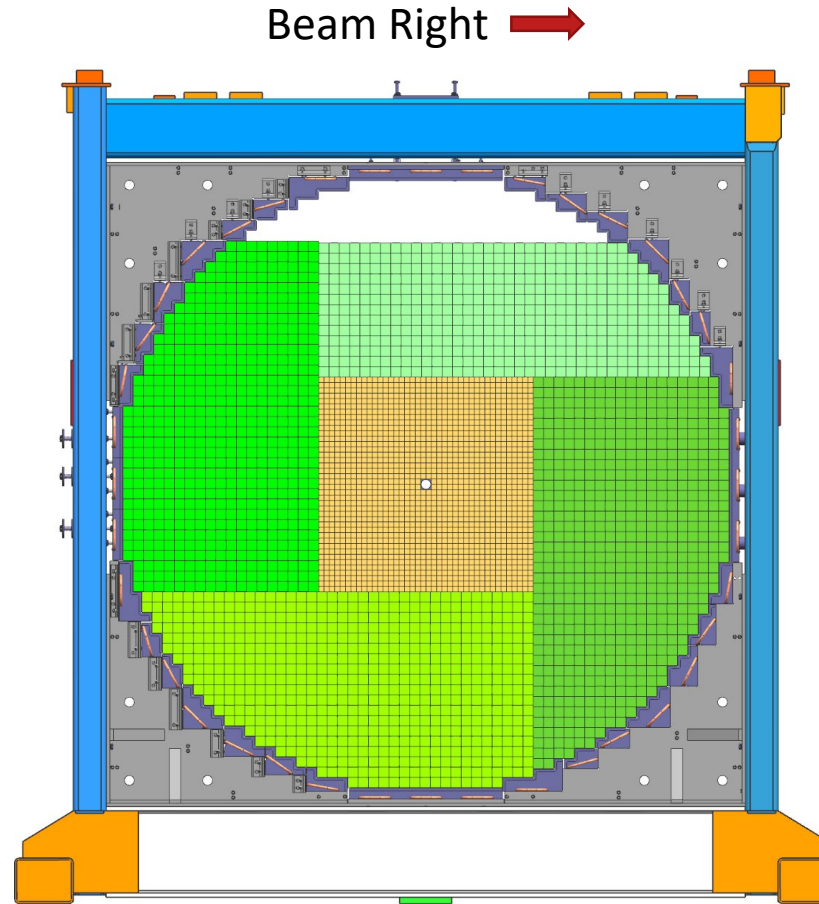

## STAGE 14

- Ensure Cooling Blocks are fully retracted both vertically and horizontally
- Lay in the next four rows of Glass Bar Modules using calculated shims (alternating each 90° along BL axis)
- Tighten these rows to Beam Right (Think Pre-Loading)
- Check the position of the Glass Bar Modules to verify correct positioning
- Release pressure (Do NOT allow Modules to move)
- Retighten Stage 13 Cooling Blocks

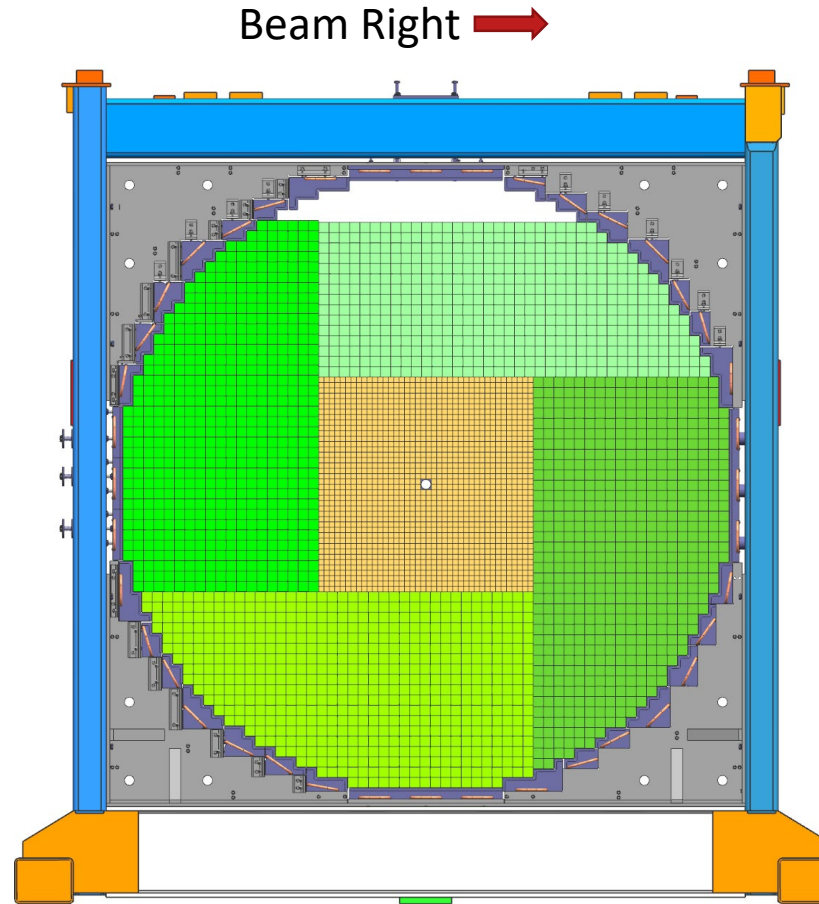

## STAGE 15

- Ensure Cooling Blocks are fully retracted both vertically and horizontally
- Lay in the next row of Glass Bar Modules using calculated shims (alternating each 90° along BL axis)
- Tighten this row to Beam Right (Think Pre-Loading)
- Check the position of the Glass Bar Modules to verify correct positioning
- Release pressure (Do NOT allow Modules to move)
- Retighten Stage 14 Cooling Blocks
- Retract Top Compression Plate fully

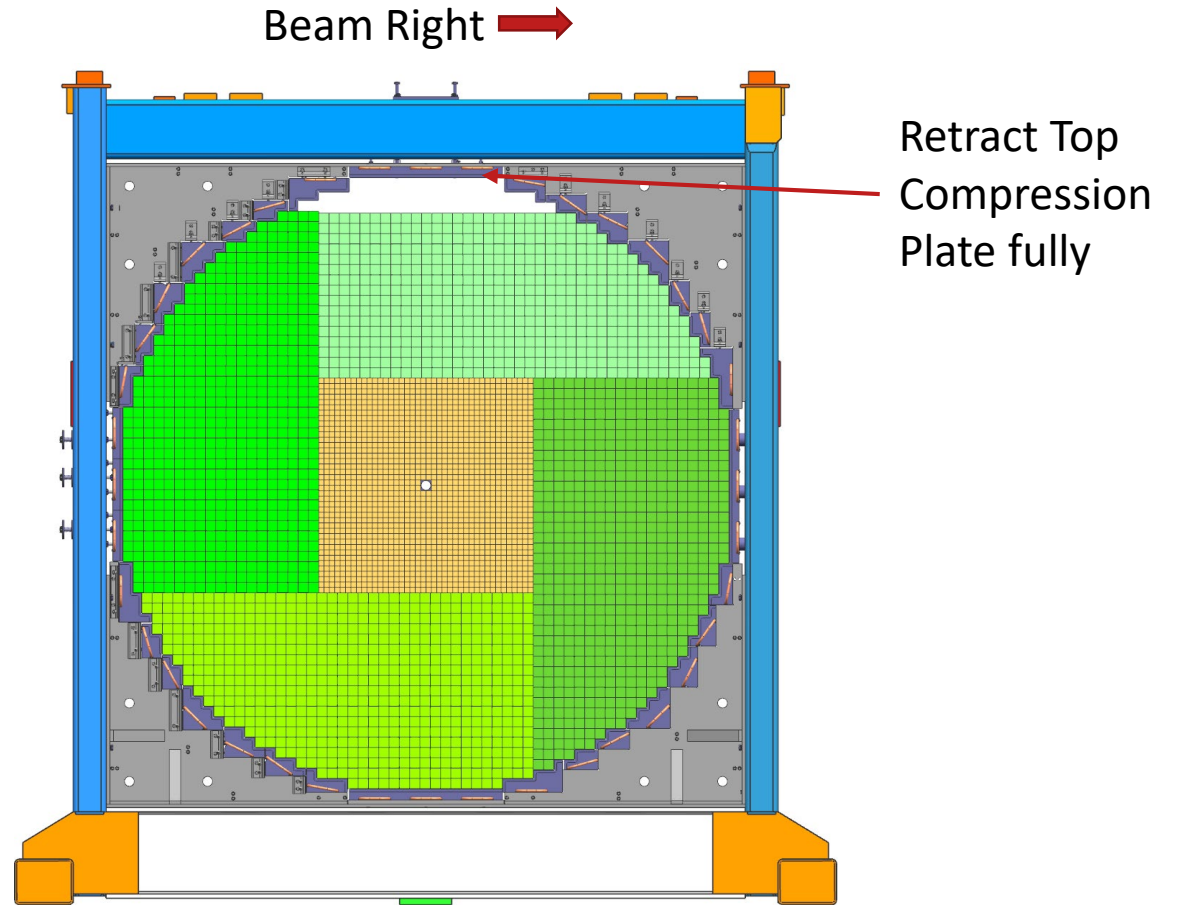

## STAGE 16

- Ensure Cooling Blocks are fully retracted both vertically and horizontally
- Lay in the next row of Glass Bar Modules using calculated shims (alternating each 90° along BL axis)
- Tighten this row to Beam Right (Think Pre-Loading)
- Check the position of the Glass Bar Modules to verify correct positioning
- Retighten Stage 15 Cooling Blocks

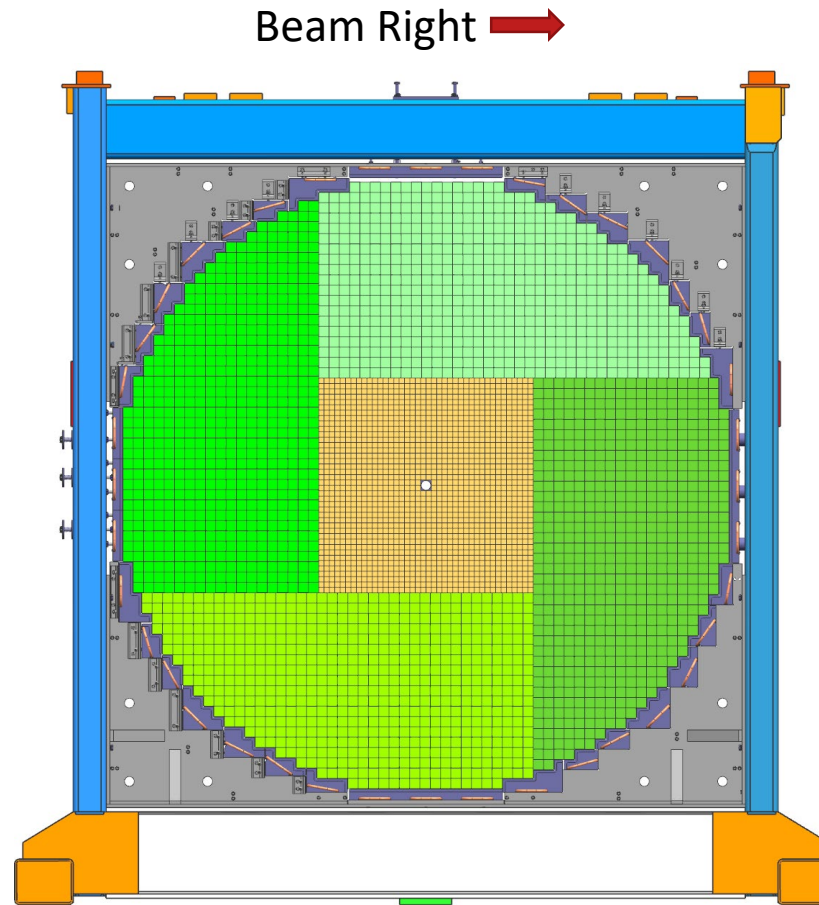

## Completed Detector Assembly

- Install Top Compression Cooling Plate in fully retracted position (if not already installed).
- Install 1/32" thermally conductive pad on top of upper row of modules
- Apply downward pressure to each Upper Cooling Blocks using provided screws
- Apply downward pressure to Top Compression Cooling Plate
- All BL compression screws should be snug and have Loctite applied if not already done
- Survey beamline center to Frame center to verify position (X -2.3mm (BR), Y – 1mm (low) relative to Hall 0,0 point)
- Install Lead Glass Block Light Monitoring System, Crystal LMS, Tungsten Absorber, Insulation, Tedlar light cover
- Temporarily install Removable Inner Tube Cooling Assy.

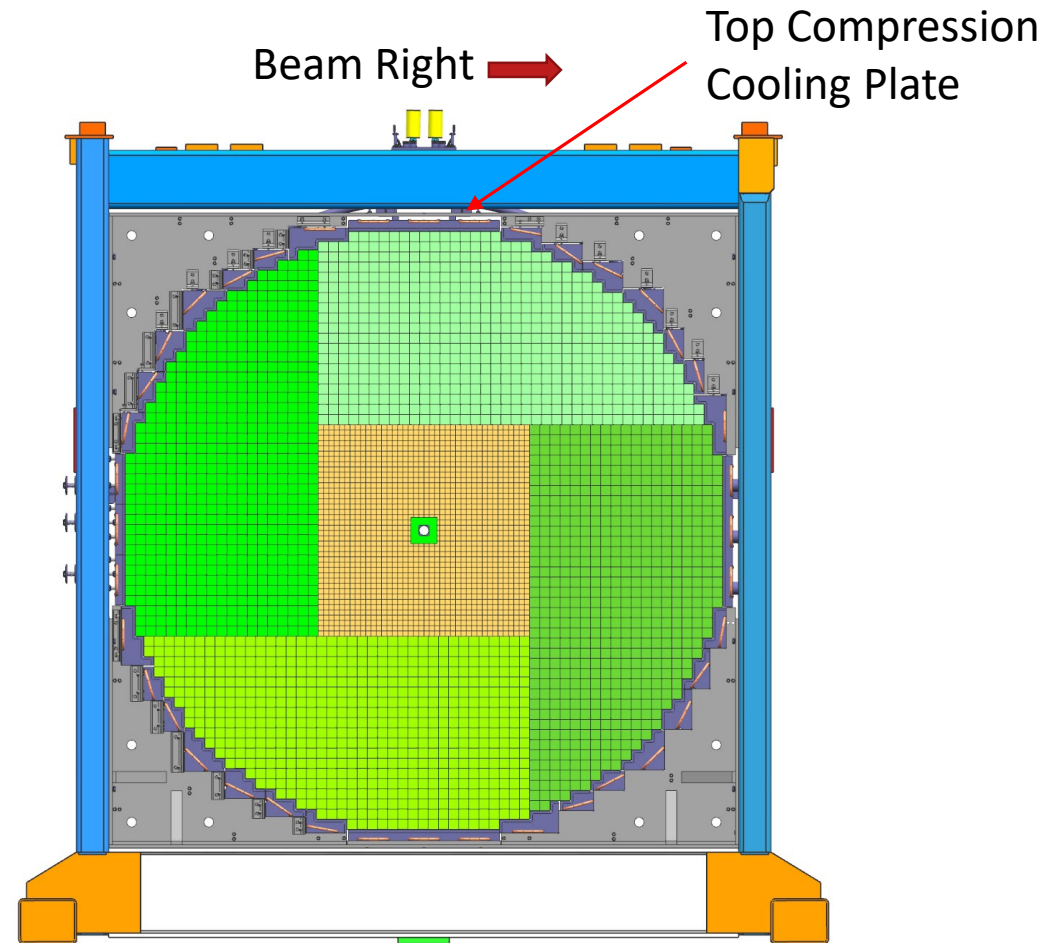

row	#modules	nom mod mm	nom width mm	crystal width	mod width	add material	Total width mm	Total width Inches	actual
59 (top)	15	40.141	602.12	n/a	n/a	n/a	602.12	23.705	
58	21	40.141	842.96	n/a	n/a	n/a	842.96	33.187	
57	25	40.141	1003.53	n/a	n/a	n/a	1003.53	39.509	
56	29	40.141	1164.09	n/a	n/a	n/a	1164.09	45.830	
55	33	40.141	1324.65	n/a	n/a	n/a	1324.65	52.152	
54	35	40.141	1404.94	n/a	n/a	n/a	1404.94	55.312	
53	39	40.141	1565.50	n/a	n/a	n/a	1565.50	61.634	
52	41	40.141	1645.78	n/a	n/a	n/a	1645.78	64.795	
51	43	40.141	1726.06	n/a	n/a	n/a	1726.06	67.955	
50	45	40.141	1806.35	n/a	n/a	n/a	1806.35	71.116	
49	47	40.141	1886.63	n/a	n/a	n/a	1886.63	74.277	
48	47	40.141	1886.63	n/a	n/a	n/a	1886.63	74.277	
47	49	40.141	1966.91	n/a	n/a	n/a	1966.91	77.437	
46	51	40.141	2047.19	n/a	n/a	n/a	2047.19	80.598	
45	51	40.141	2047.19	n/a	n/a	n/a	2047.19	80.598	
44	53	40.141	2127.47	n/a	n/a	n/a	2127.47	83.759	
43	53	40.141	2127.47	n/a	n/a	n/a	2127.47	83.759	
42	55	40.141	2207.76	n/a	n/a	n/a	2207.76	86.919	
41	55	40.141	2207.76	n/a	n/a	n/a	2207.76	86.919	
40	18	40.141	722.54	836	722.538	0	2281.08	89.806	
39	18	40.141	722.54	836	722.538	0	2281.08	89.806	
38	18	40.141	722.54	836	722.538	0	2281.08	89.806	
37	19	40.141	762.68	836	762.679	0	2361.36	92.967	
23	19	40.141	762.68	836	762.679	0	2361.36	92.967	

Table 1  
D00000-01-06-P007 Rev-

row	#modules	nom mod mm	nom width mm	crystal width	mod width	add material	Total width mm	Total width Inches	actual
23	19	40.141	762.68	836	762.679	0	2361.36	92.967	
22	18	40.141	722.54	836	722.538	0	2281.08	89.806	
21	18	40.141	722.54	836	722.538	0	2281.08	89.806	
20	18	40.141	722.54	836	722.538	0	2281.08	89.806	
19	55	40.141	2207.76	n/a	n/a	n/a	2207.76	86.919	
18	55	40.141	2207.76	n/a	n/a	n/a	2207.76	86.919	
17	53	40.141	2127.47	n/a	n/a	n/a	2127.47	83.759	
16	53	40.141	2127.47	n/a	n/a	n/a	2127.47	83.759	
15	51	40.141	2047.19	n/a	n/a	n/a	2047.19	80.598	
14	51	40.141	2047.19	n/a	n/a	n/a	2047.19	80.598	
13	49	40.141	1966.91	n/a	n/a	n/a	1966.91	77.437	
12	47	40.141	1886.63	n/a	n/a	n/a	1886.63	74.277	
11	47	40.141	1886.63	n/a	n/a	n/a	1886.63	74.277	
10	45	40.141	1806.35	n/a	n/a	n/a	1806.35	71.116	
9	43	40.141	1726.06	n/a	n/a	n/a	1726.06	67.955	
8	41	40.141	1645.78	n/a	n/a	n/a	1645.78	64.795	
7	39	40.141	1565.50	n/a	n/a	n/a	1565.50	61.634	
6	35	40.141	1404.94	n/a	n/a	n/a	1404.94	55.312	
5	33	40.141	1324.65	n/a	n/a	n/a	1324.65	52.152	
4	29	40.141	1164.09	n/a	n/a	n/a	1164.09	45.830	
3	25	40.141	1003.53	n/a	n/a	n/a	1003.53	39.509	
2	21	40.141	842.96	n/a	n/a	n/a	842.96	33.187	
1 (bot)	15	40.141	602.12	n/a	n/a	n/a	602.12	23.705	

Table 1 con't