

J-Lab Meeting Notes (10 June, 2014)

Problem: Unacceptably high noise in TIA circuit (Note: input signal is a sine wave with a frequency of 5.0 MHz and an amplitude of 3.5 mV through a 100 pF blocking capacitor and then a 100 ohm resistor, expected current into amplifier ~35 uA)

Likely Cause: Multiple feedback oscillations due to high gain and high slew rate of the circuit

Solution: Isolate feedback frequencies and tune circuitry to remove them

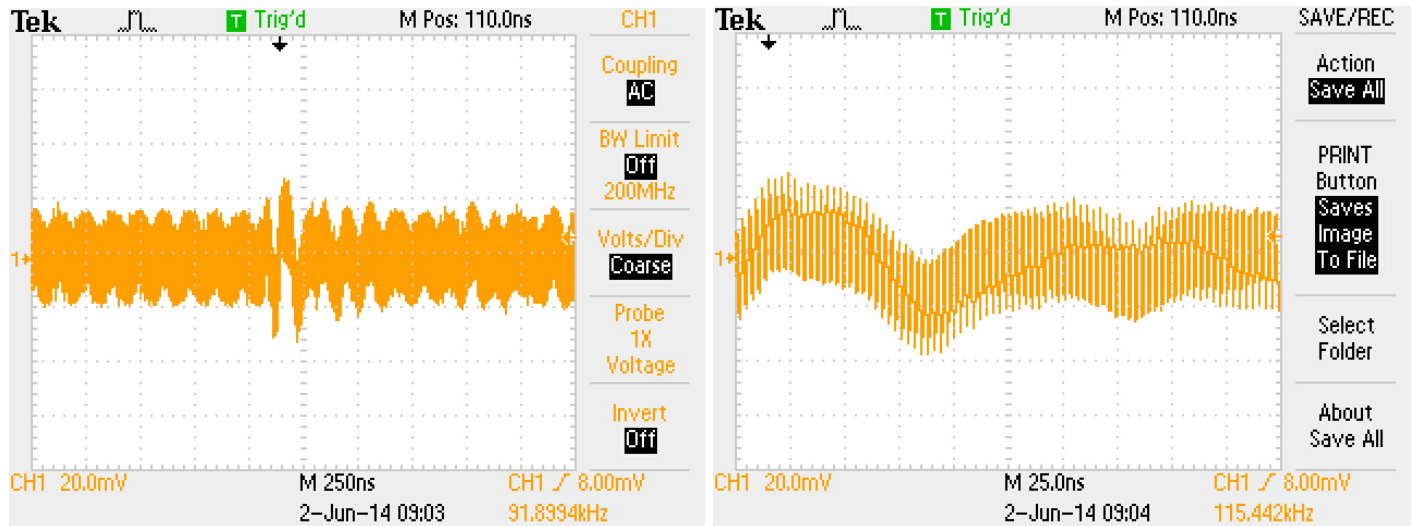

Difficult to visualize the feedback frequencies using just the waveform, use fourier analysis to visualize these frequencies:

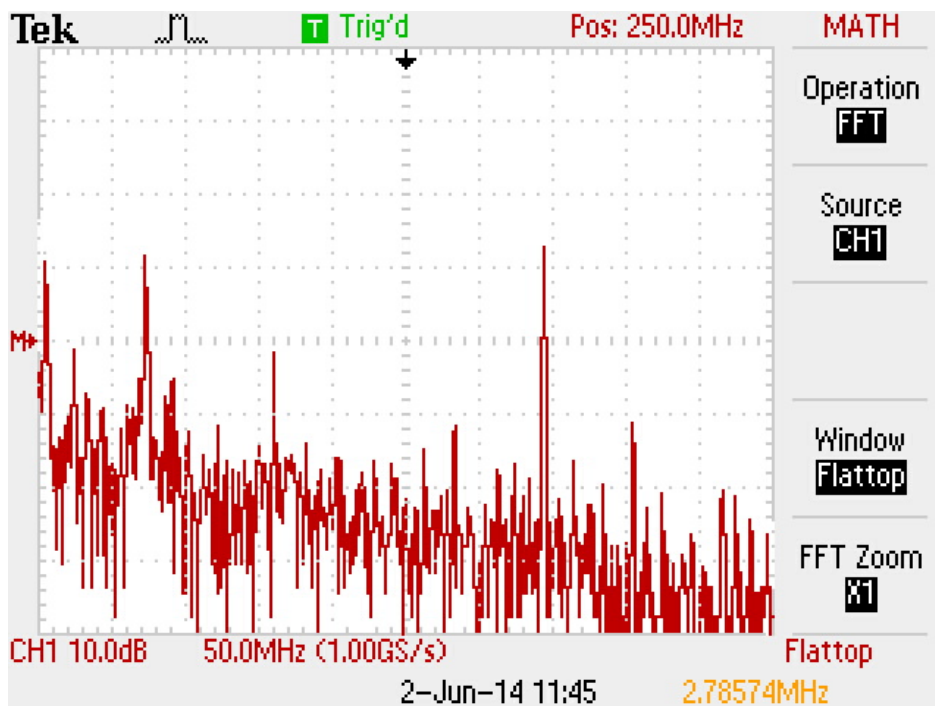

Before and after comparisons:

Before:

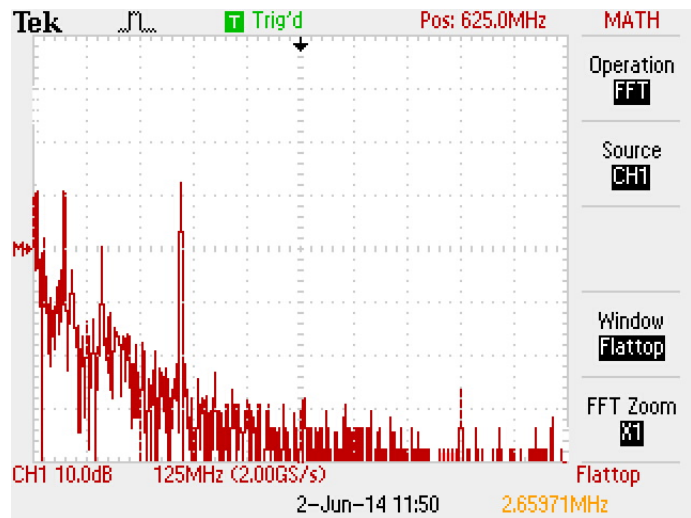

After:

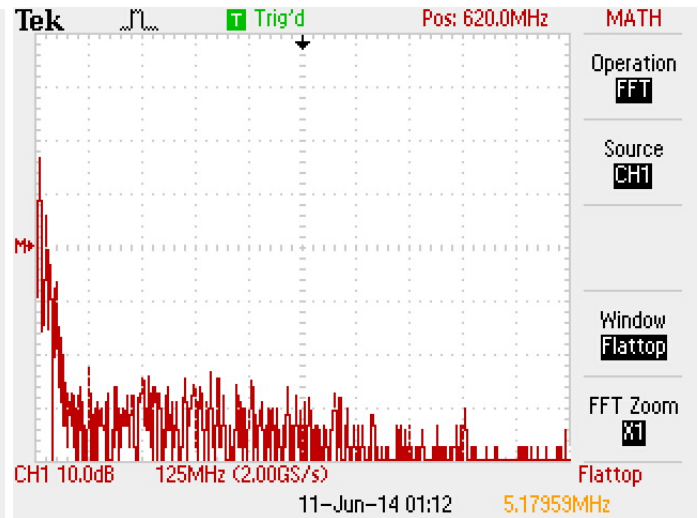

Before:

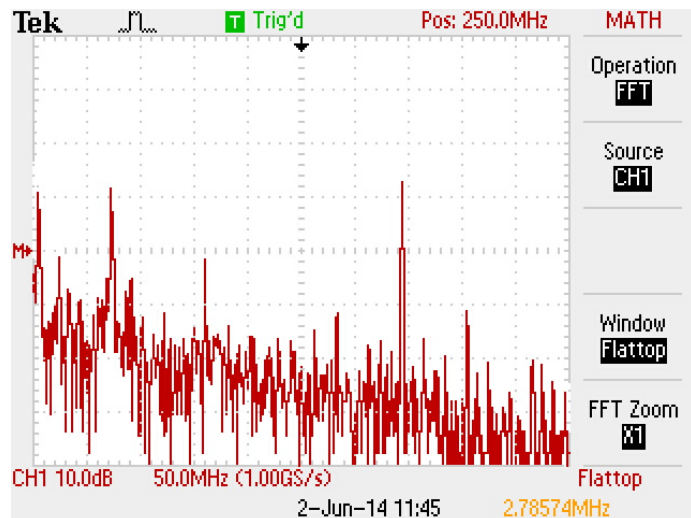

After:

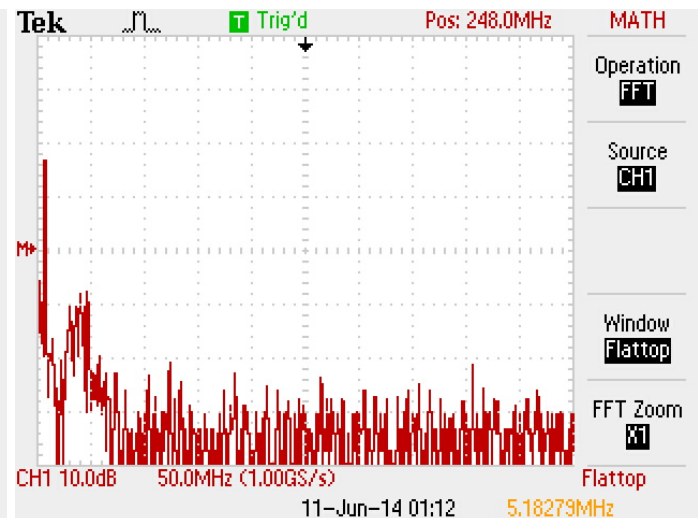

Before:

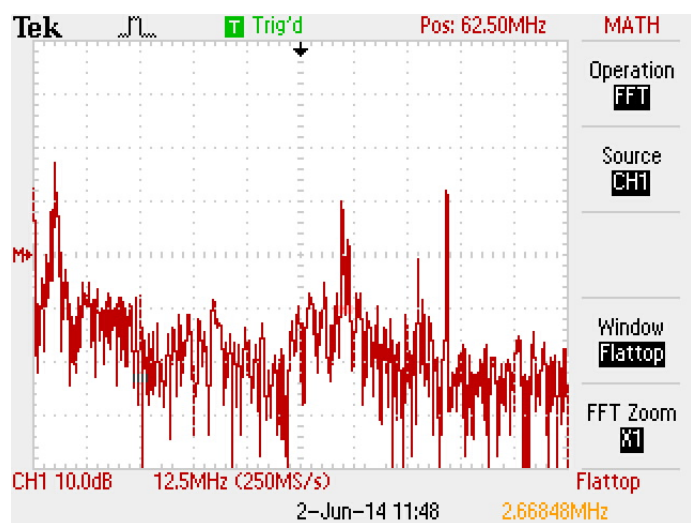

After:

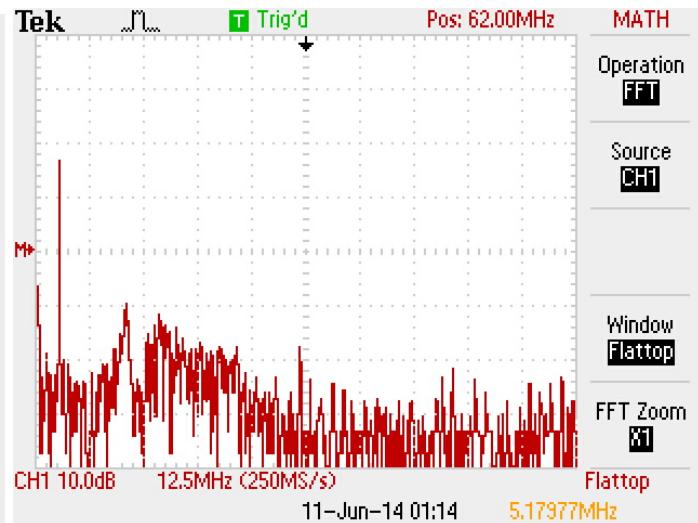

Waveforms now:

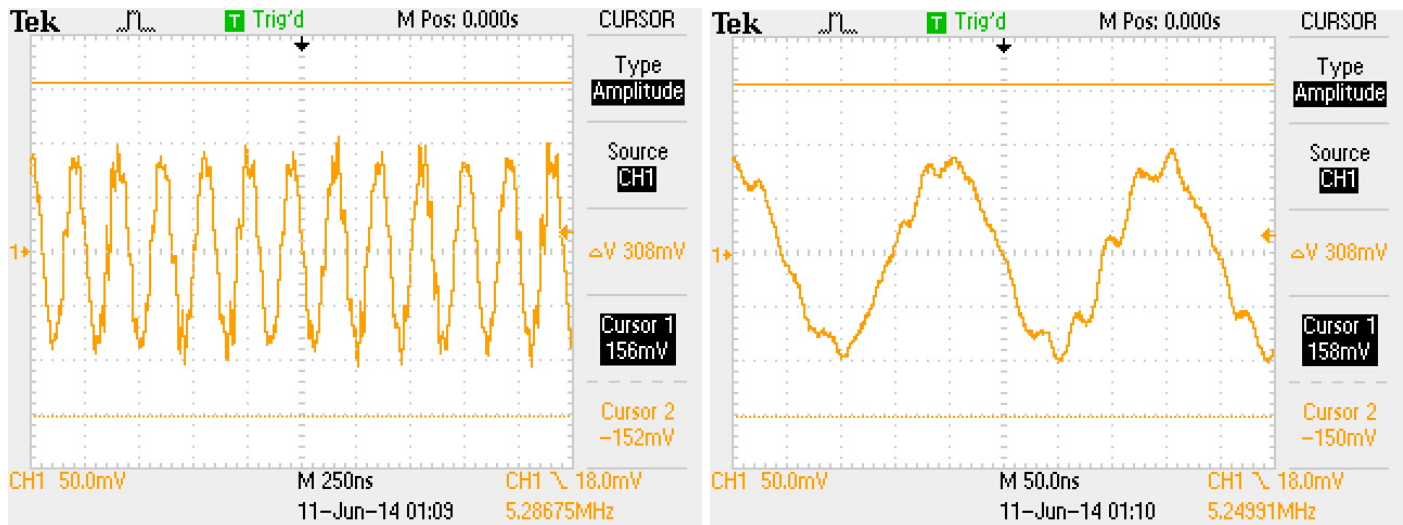

The circuit shows definite improvement but a bit more work is still necessary. The next revision is currently being designed in Altium (I switched from Eagle after talking to Mr. Barbosa). It will probably be sent out to be manufactured in a few days.

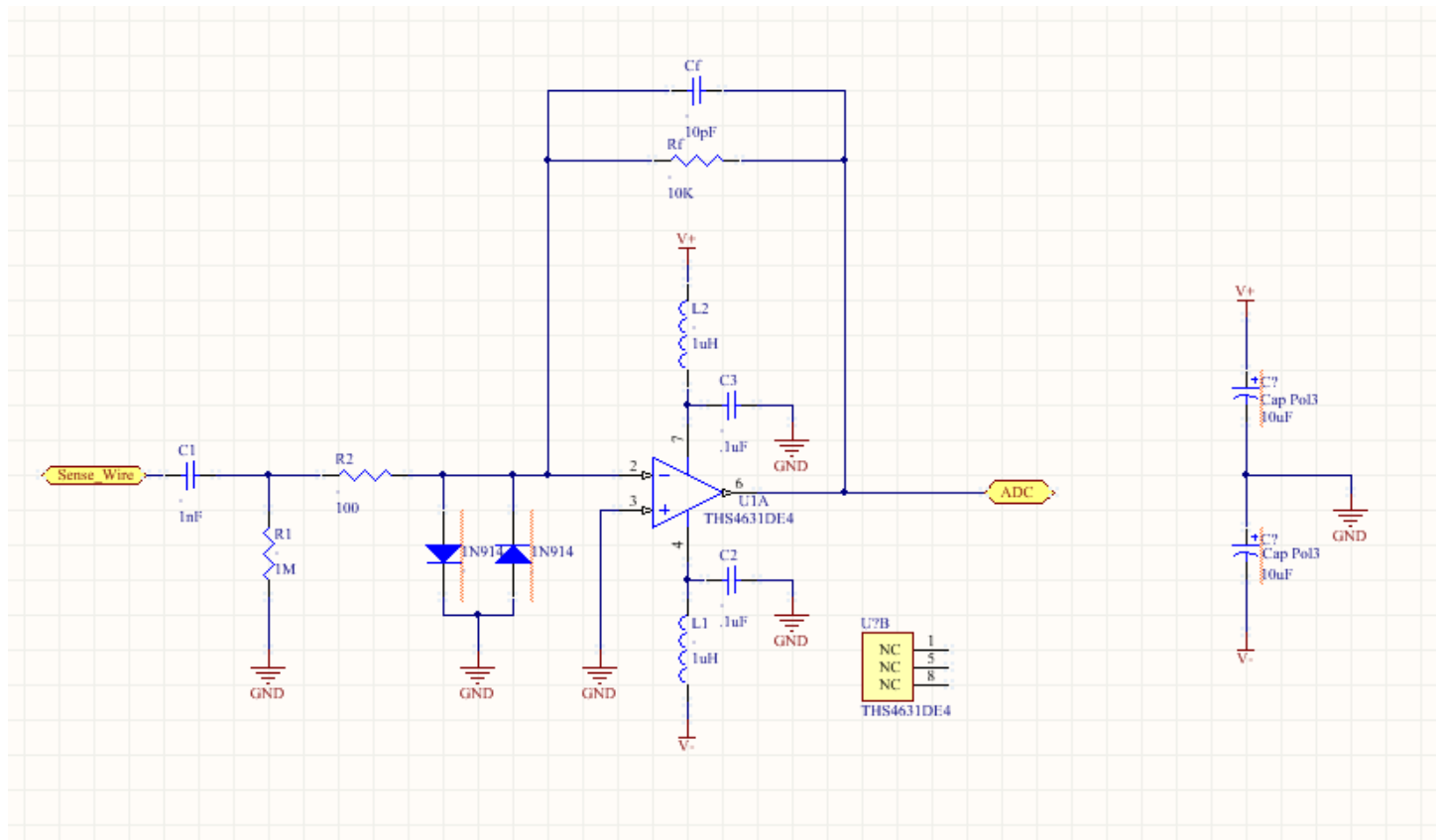

Major changes include the addition of ferrite beads to the Op Amp power supply traces to minimize interference between the channels. Also, diode protection was added to the input of the amplifier.