

# A1

wire D5 ( 27, 35) pad 0 distance 43mm 1.7in +2.3= 4.00in wire 4.50in  
 wire A5 ( 20, 79) pad 1 distance 47mm 1.9in +2.3= 4.17in wire 4.50in  
 wire C5 ( 34, 50) pad 2 distance 43mm 1.7in +2.3= 4.02in wire 4.50in  
 wire B4 ( 29, 66) pad 3 distance 47mm 1.9in +2.3= 4.18in wire 4.50in  
 wire D4 ( 45, 38) pad 4 distance 38mm 1.5in +2.3= 3.83in wire 4.00in  
 wire A4 ( 36, 81) pad 5 distance 44mm 1.7in +2.3= 4.04in wire 4.50in  
 wire C4 ( 50, 53) pad 6 distance 39mm 1.5in +2.3= 3.84in wire 4.00in  
 wire B3 ( 47, 70) pad 7 distance 42mm 1.6in +2.3= 3.97in wire 4.00in  
 wire D3 ( 62, 42) pad 8 distance 36mm 1.4in +2.3= 3.74in wire 3.75in  
 wire A3 ( 51, 85) pad 9 distance 41mm 1.6in +2.3= 3.93in wire 4.00in  
 wire C3 ( 65, 58) pad 10 distance 42mm 1.6in +2.3= 3.97in wire 4.00in  
 wire B2 ( 64, 76) pad 11 distance 37mm 1.5in +2.3= 3.79in wire 4.00in  
 wire D2 ( 78, 48) pad 12 distance 36mm 1.4in +2.3= 3.73in wire 3.75in  
 wire A2 ( 66, 92) pad 13 distance 39mm 1.5in +2.3= 3.87in wire 4.00in  
 wire C2 ( 80, 64) pad 14 distance 44mm 1.8in +2.3= 4.07in wire 4.50in  
 wire A1 ( 79,100) pad 15 distance 39mm 1.5in +2.3= 3.85in wire 4.00in  
 wire D1 ( 94, 57) pad 16 distance 39mm 1.5in +2.3= 3.84in wire 4.00in  
 wire B1 ( 80, 84) pad 17 distance 37mm 1.4in +2.3= 3.77in wire 4.00in  
 wire C1 ( 93, 73) pad 18 distance 49mm 1.9in +2.3= 4.24in wire 4.50in  
 wire A42 ( 91,111) pad 19 distance 44mm 1.7in +2.3= 4.07in wire 4.50in  
 wire D54 (108, 67) pad 20 distance 44mm 1.7in +2.3= 4.05in wire 4.50in  
 wire B42 ( 94, 95) pad 21 distance 38mm 1.5in +2.3= 3.81in wire 4.00in  
 wire D53 (121, 78) pad 22 distance 52mm 2.1in +2.3= 4.38in wire 4.50in  
 wire C54 (106, 83) pad 23 distance 34mm 1.3in +2.3= 3.65in wire 3.75in

Longest wire D53 at 111.2mm 4.38in Mean dist 100.3mm 3.95in

3 3.75-inch wires 11 4-inch wires 10 4.5-inch wires 0 5-inch wires 0 longer wires

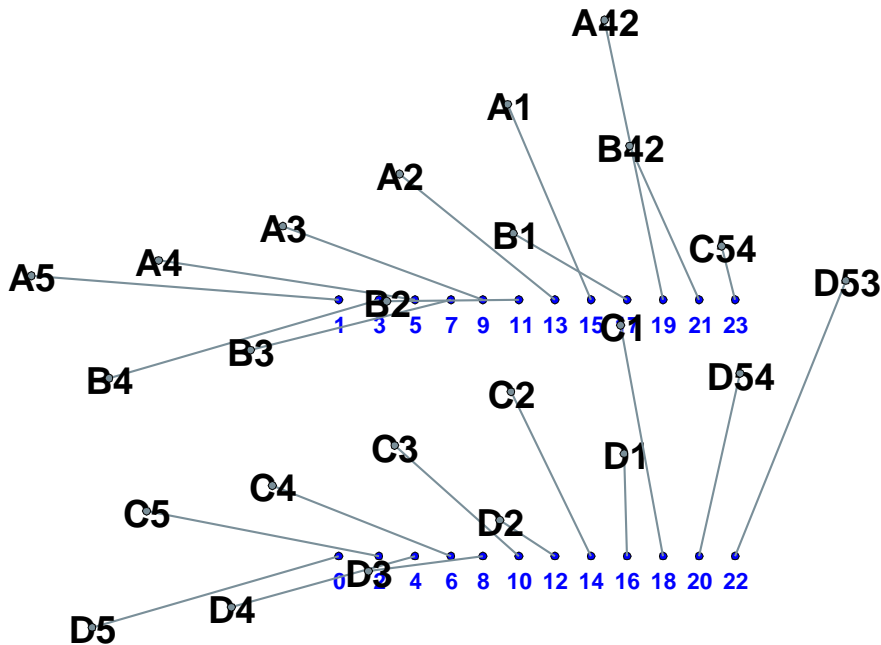

## A2

wire D12 ( 18, 33) pad 0 distance 49mm 1.9in +2.3= 4.26in wire 4.50in  
 wire A10 ( 20, 77) pad 1 distance 47mm 1.8in +2.3= 4.17in wire 4.50in  
 wire C12 ( 26, 47) pad 2 distance 48mm 1.9in +2.3= 4.20in wire 4.50in  
 wire B9 ( 30, 64) pad 3 distance 47mm 1.9in +2.3= 4.19in wire 4.50in  
 wire D11 ( 36, 34) pad 4 distance 44mm 1.7in +2.3= 4.05in wire 4.50in  
 wire A9 ( 36, 79) pad 5 distance 43mm 1.7in +2.3= 4.03in wire 4.50in  
 wire C11 ( 42, 49) pad 6 distance 43mm 1.7in +2.3= 4.01in wire 4.50in  
 wire B8 ( 47, 68) pad 7 distance 42mm 1.7in +2.3= 3.98in wire 4.00in  
 wire D10 ( 53, 38) pad 8 distance 40mm 1.6in +2.3= 3.89in wire 4.00in  
 wire A8 ( 51, 84) pad 9 distance 41mm 1.6in +2.3= 3.92in wire 4.00in  
 wire C10 ( 57, 53) pad 10 distance 43mm 1.7in +2.3= 4.03in wire 4.50in  
 wire B7 ( 64, 74) pad 11 distance 38mm 1.5in +2.3= 3.80in wire 4.00in  
 wire D9 ( 70, 43) pad 12 distance 37mm 1.5in +2.3= 3.78in wire 4.00in  
 wire A7 ( 66, 90) pad 13 distance 39mm 1.5in +2.3= 3.85in wire 4.00in  
 wire C9 ( 72, 59) pad 14 distance 44mm 1.7in +2.3= 4.06in wire 4.50in  
 wire A6 ( 79, 99) pad 15 distance 38mm 1.5in +2.3= 3.83in wire 4.00in  
 wire D8 ( 86, 51) pad 16 distance 37mm 1.5in +2.3= 3.79in wire 4.00in  
 wire B6 ( 80, 83) pad 17 distance 37mm 1.4in +2.3= 3.76in wire 4.00in  
 wire C8 ( 86, 67) pad 18 distance 46mm 1.8in +2.3= 4.14in wire 4.50in  
 wire B5 ( 94, 94) pad 19 distance 35mm 1.4in +2.3= 3.72in wire 3.75in  
 wire D7 (100, 60) pad 20 distance 40mm 1.6in +2.3= 3.89in wire 4.00in  
 wire C7 ( 99, 76) pad 21 distance 34mm 1.4in +2.3= 3.68in wire 3.75in  
 wire D6 (114, 71) pad 22 distance 46mm 1.8in +2.3= 4.12in wire 4.50in  
 wire C6 (111, 86) pad 23 distance 33mm 1.3in +2.3= 3.63in wire 3.75in

Longest wire D12 at 108.2mm 4.26in Mean dist 100.3mm 3.95in

3 3.75-inch wires 10 4-inch wires 11 4.5-inch wires 0 5-inch wires 0 longer wires

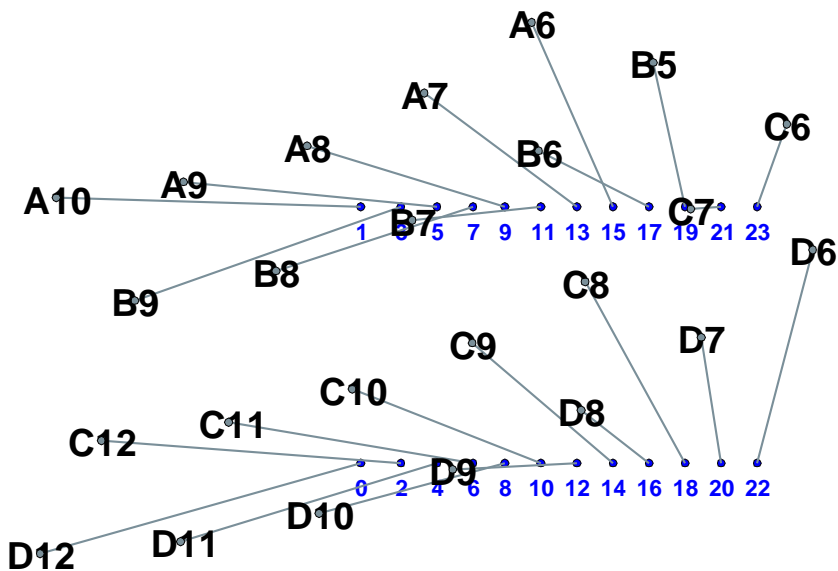

### A3

wire C19 ( 17, 49) pad 0 distance 51mm 2.0in +2.3= 4.32in wire 4.50in  
 wire B15 ( 12, 66) pad 1 distance 54mm 2.1in +2.3= 4.46in wire 4.50in  
 wire D18 ( 26, 36) pad 2 distance 47mm 1.9in +2.3= 4.18in wire 4.50in  
 wire A15 ( 21, 80) pad 3 distance 50mm 2.0in +2.3= 4.31in wire 4.50in  
 wire C18 ( 33, 50) pad 4 distance 47mm 1.9in +2.3= 4.17in wire 4.50in  
 wire B14 ( 30, 67) pad 5 distance 49mm 1.9in +2.3= 4.27in wire 4.50in  
 wire C17 ( 48, 53) pad 6 distance 39mm 1.5in +2.3= 3.86in wire 4.00in  
 wire A14 ( 37, 81) pad 7 distance 46mm 1.8in +2.3= 4.13in wire 4.50in  
 wire D17 ( 43, 38) pad 8 distance 46mm 1.8in +2.3= 4.13in wire 4.50in  
 wire B13 ( 48, 70) pad 9 distance 44mm 1.8in +2.3= 4.07in wire 4.50in  
 wire D16 ( 60, 42) pad 10 distance 39mm 1.5in +2.3= 3.85in wire 4.00in  
 wire A13 ( 52, 86) pad 11 distance 43mm 1.7in +2.3= 4.02in wire 4.50in  
 wire C16 ( 64, 57) pad 12 distance 44mm 1.7in +2.3= 4.06in wire 4.50in  
 wire B12 ( 65, 76) pad 13 distance 39mm 1.5in +2.3= 3.86in wire 4.00in  
 wire D15 ( 77, 47) pad 14 distance 37mm 1.5in +2.3= 3.80in wire 4.00in  
 wire A12 ( 67, 92) pad 15 distance 41mm 1.6in +2.3= 3.94in wire 4.00in  
 wire C15 ( 79, 63) pad 16 distance 46mm 1.8in +2.3= 4.12in wire 4.50in  
 wire A11 ( 81,100) pad 17 distance 40mm 1.6in +2.3= 3.91in wire 4.00in  
 wire D14 ( 92, 55) pad 18 distance 38mm 1.5in +2.3= 3.83in wire 4.00in  
 wire B11 ( 81, 84) pad 19 distance 38mm 1.5in +2.3= 3.84in wire 4.00in  
 wire C14 ( 93, 71) pad 20 distance 49mm 1.9in +2.3= 4.24in wire 4.50in  
 wire B10 ( 96, 95) pad 21 distance 37mm 1.5in +2.3= 3.78in wire 4.00in  
 wire D13 (107, 65) pad 22 distance 42mm 1.7in +2.3= 3.98in wire 4.00in  
 wire C13 (106, 81) pad 23 distance 34mm 1.3in +2.3= 3.65in wire 3.75in

Longest wire B15 at 113.4mm 4.46in Mean dist 102.4mm 4.03in

1 3.75-inch wires 10 4-inch wires 13 4.5-inch wires 0 5-inch wires 0 longer wires

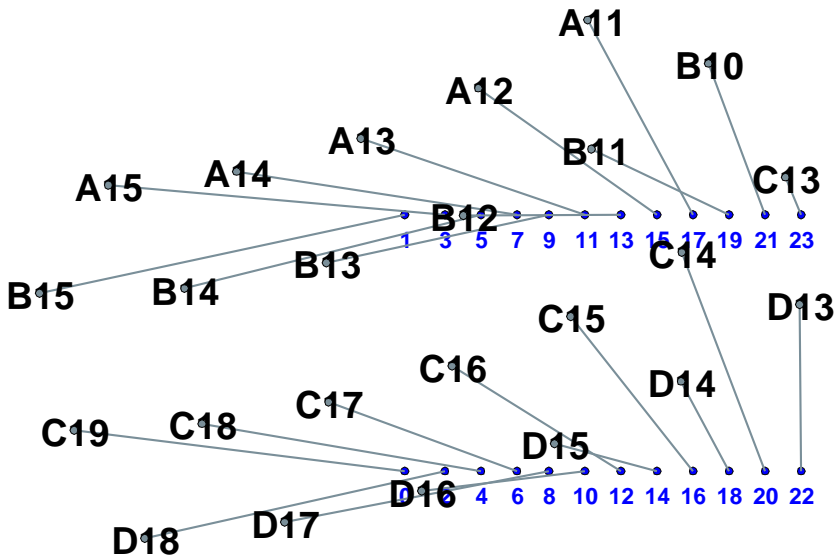

## A4

wire C26 ( 17, 52) pad 0 distance 51mm 2.0in +2.3= 4.34in wire 4.50in  
 wire B20 ( 21, 69) pad 1 distance 47mm 1.9in +2.3= 4.19in wire 4.50in  
 wire D25 ( 25, 38) pad 2 distance 47mm 1.9in +2.3= 4.18in wire 4.50in  
 wire A20 ( 29, 83) pad 3 distance 44mm 1.7in +2.3= 4.07in wire 4.50in  
 wire C25 ( 33, 52) pad 4 distance 48mm 1.9in +2.3= 4.19in wire 4.50in  
 wire B19 ( 39, 70) pad 5 distance 43mm 1.7in +2.3= 4.01in wire 4.50in  
 wire C24 ( 49, 55) pad 6 distance 39mm 1.5in +2.3= 3.87in wire 4.00in  
 wire A19 ( 45, 85) pad 7 distance 41mm 1.6in +2.3= 3.93in wire 4.00in  
 wire D24 ( 43, 40) pad 8 distance 46mm 1.8in +2.3= 4.14in wire 4.50in  
 wire B18 ( 57, 74) pad 9 distance 39mm 1.5in +2.3= 3.85in wire 4.00in  
 wire D23 ( 60, 43) pad 10 distance 39mm 1.5in +2.3= 3.86in wire 4.00in  
 wire A18 ( 60, 90) pad 11 distance 39mm 1.5in +2.3= 3.86in wire 4.00in  
 wire C23 ( 64, 59) pad 12 distance 45mm 1.8in +2.3= 4.08in wire 4.50in  
 wire B17 ( 74, 81) pad 13 distance 35mm 1.4in +2.3= 3.70in wire 3.75in  
 wire D22 ( 77, 49) pad 14 distance 38mm 1.5in +2.3= 3.81in wire 4.00in  
 wire A17 ( 75, 97) pad 15 distance 39mm 1.5in +2.3= 3.85in wire 4.00in  
 wire C22 ( 79, 64) pad 16 distance 46mm 1.8in +2.3= 4.14in wire 4.50in  
 wire A16 ( 88,106) pad 17 distance 41mm 1.6in +2.3= 3.93in wire 4.00in  
 wire D21 ( 93, 56) pad 18 distance 38mm 1.5in +2.3= 3.84in wire 4.00in  
 wire B16 ( 89, 90) pad 19 distance 36mm 1.4in +2.3= 3.73in wire 3.75in  
 wire C21 ( 93, 72) pad 20 distance 49mm 1.9in +2.3= 4.26in wire 4.50in  
 wire C20 (107, 81) pad 21 distance 33mm 1.3in +2.3= 3.62in wire 3.75in  
 wire D20 (108, 65) pad 22 distance 42mm 1.7in +2.3= 3.99in wire 4.00in  
 wire D19 (122, 76) pad 23 distance 35mm 1.4in +2.3= 3.70in wire 3.75in

Longest wire C26 at 110.4mm 4.34in Mean dist 100.7mm 3.96in

4 3.75-inch wires 10 4-inch wires 10 4.5-inch wires 0 5-inch wires 0 longer wires

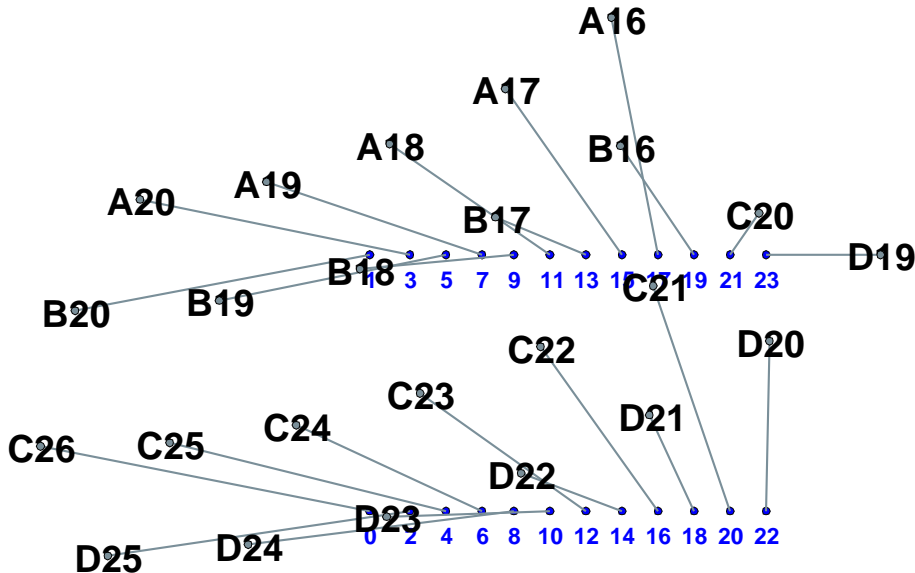

## A5

wire D32 ( 26, 36) pad 0 distance 44mm 1.7in +2.3= 4.04in wire 4.50in  
 wire A26 ( 20, 80) pad 1 distance 47mm 1.8in +2.3= 4.16in wire 4.50in  
 wire C32 ( 33, 50) pad 2 distance 44mm 1.7in +2.3= 4.04in wire 4.50in  
 wire B25 ( 29, 66) pad 3 distance 47mm 1.9in +2.3= 4.18in wire 4.50in  
 wire D31 ( 43, 37) pad 4 distance 39mm 1.5in +2.3= 3.86in wire 4.00in  
 wire A25 ( 36, 81) pad 5 distance 43mm 1.7in +2.3= 4.03in wire 4.50in  
 wire C31 ( 49, 52) pad 6 distance 39mm 1.5in +2.3= 3.85in wire 4.00in  
 wire B24 ( 47, 69) pad 7 distance 42mm 1.7in +2.3= 3.98in wire 4.00in  
 wire D30 ( 60, 41) pad 8 distance 36mm 1.4in +2.3= 3.75in wire 4.00in  
 wire A24 ( 52, 85) pad 9 distance 40mm 1.6in +2.3= 3.92in wire 4.00in  
 wire C30 ( 64, 57) pad 10 distance 41mm 1.6in +2.3= 3.95in wire 4.00in  
 wire B23 ( 64, 75) pad 11 distance 38mm 1.5in +2.3= 3.80in wire 4.00in  
 wire D29 ( 77, 47) pad 12 distance 35mm 1.4in +2.3= 3.71in wire 3.75in  
 wire A23 ( 67, 90) pad 13 distance 39mm 1.5in +2.3= 3.84in wire 4.00in  
 wire C29 ( 79, 63) pad 14 distance 43mm 1.7in +2.3= 4.03in wire 4.50in  
 wire A22 ( 80, 98) pad 15 distance 38mm 1.5in +2.3= 3.81in wire 4.00in  
 wire D28 ( 93, 54) pad 16 distance 37mm 1.5in +2.3= 3.79in wire 4.00in  
 wire B22 ( 80, 82) pad 17 distance 36mm 1.4in +2.3= 3.76in wire 4.00in  
 wire C28 ( 93, 70) pad 18 distance 47mm 1.8in +2.3= 4.17in wire 4.50in  
 wire A21 ( 93,108) pad 19 distance 42mm 1.7in +2.3= 4.00in wire 4.00in  
 wire D27 (108, 64) pad 20 distance 42mm 1.6in +2.3= 3.97in wire 4.00in  
 wire B21 ( 95, 93) pad 21 distance 37mm 1.4in +2.3= 3.76in wire 4.00in  
 wire D26 (122, 75) pad 22 distance 50mm 2.0in +2.3= 4.28in wire 4.50in  
 wire C27 (106, 80) pad 23 distance 34mm 1.3in +2.3= 3.64in wire 3.75in

Longest wire D26 at 108.6mm 4.28in Mean dist 99.8mm 3.93in

2 3.75-inch wires 14 4-inch wires 8 4.5-inch wires 0 5-inch wires 0 longer wires

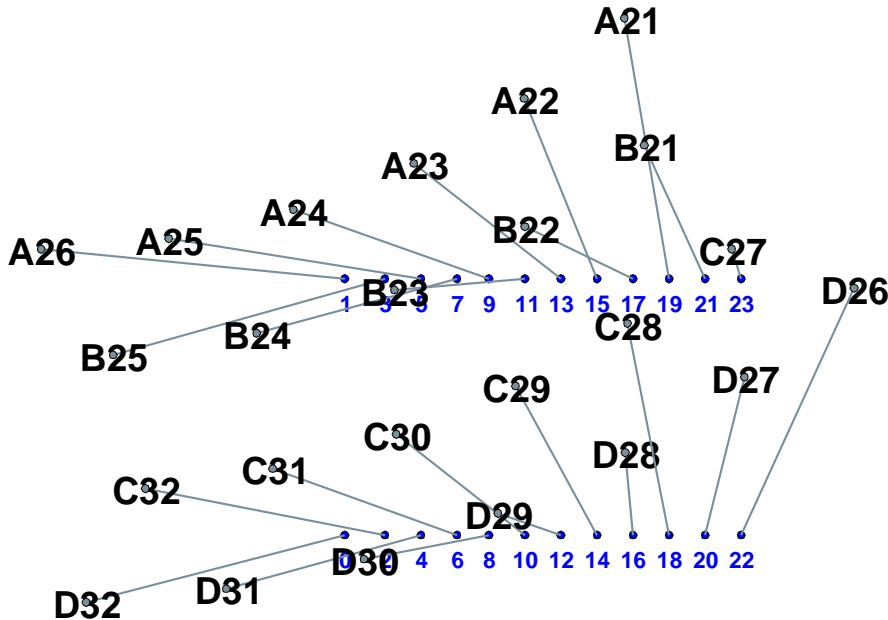

## A6

wire D39 ( 18, 33) pad 0 distance 49mm 1.9in +2.3= 4.26in wire 4.50in  
 wire A31 ( 21, 77) pad 1 distance 46mm 1.8in +2.3= 4.14in wire 4.50in  
 wire C39 ( 26, 47) pad 2 distance 48mm 1.9in +2.3= 4.19in wire 4.50in  
 wire B30 ( 30, 64) pad 3 distance 47mm 1.8in +2.3= 4.17in wire 4.50in  
 wire D38 ( 36, 34) pad 4 distance 44mm 1.7in +2.3= 4.04in wire 4.50in  
 wire A30 ( 37, 79) pad 5 distance 43mm 1.7in +2.3= 4.01in wire 4.50in  
 wire C38 ( 42, 49) pad 6 distance 43mm 1.7in +2.3= 4.00in wire 4.50in  
 wire B29 ( 48, 68) pad 7 distance 42mm 1.6in +2.3= 3.97in wire 4.00in  
 wire D37 ( 53, 38) pad 8 distance 40mm 1.6in +2.3= 3.88in wire 4.00in  
 wire A29 ( 52, 83) pad 9 distance 40mm 1.6in +2.3= 3.90in wire 4.00in  
 wire C37 ( 58, 53) pad 10 distance 43mm 1.7in +2.3= 4.02in wire 4.50in  
 wire B28 ( 65, 74) pad 11 distance 37mm 1.5in +2.3= 3.79in wire 4.00in  
 wire D36 ( 70, 43) pad 12 distance 37mm 1.4in +2.3= 3.77in wire 4.00in  
 wire A28 ( 67, 90) pad 13 distance 38mm 1.5in +2.3= 3.83in wire 4.00in  
 wire C36 ( 72, 58) pad 14 distance 44mm 1.7in +2.3= 4.04in wire 4.50in  
 wire A27 ( 81, 98) pad 15 distance 38mm 1.5in +2.3= 3.80in wire 4.00in  
 wire D35 ( 86, 50) pad 16 distance 37mm 1.4in +2.3= 3.77in wire 4.00in  
 wire B27 ( 81, 82) pad 17 distance 36mm 1.4in +2.3= 3.75in wire 3.75in  
 wire C35 ( 87, 66) pad 18 distance 46mm 1.8in +2.3= 4.11in wire 4.50in  
 wire B26 ( 96, 93) pad 19 distance 35mm 1.4in +2.3= 3.70in wire 3.75in  
 wire D34 (101, 59) pad 20 distance 39mm 1.5in +2.3= 3.87in wire 4.00in  
 wire C34 (100, 75) pad 21 distance 34mm 1.4in +2.3= 3.68in wire 3.75in  
 wire D33 (115, 69) pad 22 distance 45mm 1.8in +2.3= 4.09in wire 4.50in  
 wire C33 (112, 85) pad 23 distance 33mm 1.3in +2.3= 3.63in wire 3.75in

Longest wire D39 at 108.1mm 4.26in Mean dist 99.9mm 3.93in

4 3.75-inch wires 9 4-inch wires 11 4.5-inch wires 0 5-inch wires 0 longer wires

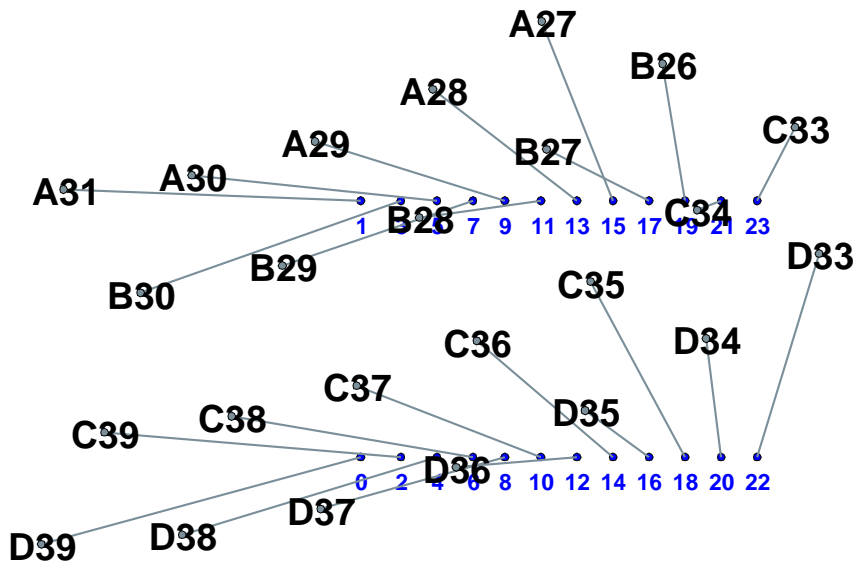

## A7

wire C46 ( 17, 49) pad 0 distance 51mm 2.0in +2.3= 4.32in wire 4.50in  
 wire B36 ( 12, 66) pad 1 distance 54mm 2.1in +2.3= 4.47in wire 4.50in  
 wire D45 ( 26, 35) pad 2 distance 47mm 1.9in +2.3= 4.18in wire 4.50in  
 wire A36 ( 21, 79) pad 3 distance 50mm 2.0in +2.3= 4.31in wire 4.50in  
 wire C45 ( 33, 50) pad 4 distance 47mm 1.8in +2.3= 4.17in wire 4.50in  
 wire B35 ( 30, 66) pad 5 distance 50mm 2.0in +2.3= 4.27in wire 4.50in  
 wire C44 ( 49, 52) pad 6 distance 39mm 1.5in +2.3= 3.86in wire 4.00in  
 wire A35 ( 37, 81) pad 7 distance 46mm 1.8in +2.3= 4.13in wire 4.50in  
 wire D44 ( 43, 37) pad 8 distance 46mm 1.8in +2.3= 4.13in wire 4.50in  
 wire B34 ( 48, 70) pad 9 distance 45mm 1.8in +2.3= 4.08in wire 4.50in  
 wire D43 ( 60, 41) pad 10 distance 39mm 1.5in +2.3= 3.85in wire 4.00in  
 wire A34 ( 52, 85) pad 11 distance 43mm 1.7in +2.3= 4.02in wire 4.50in  
 wire C43 ( 64, 57) pad 12 distance 44mm 1.7in +2.3= 4.05in wire 4.50in  
 wire B33 ( 65, 76) pad 13 distance 39mm 1.5in +2.3= 3.86in wire 4.00in  
 wire D42 ( 77, 47) pad 14 distance 37mm 1.5in +2.3= 3.79in wire 4.00in  
 wire A33 ( 67, 91) pad 15 distance 41mm 1.6in +2.3= 3.94in wire 4.00in  
 wire C42 ( 79, 63) pad 16 distance 45mm 1.8in +2.3= 4.11in wire 4.50in  
 wire A32 ( 81,100) pad 17 distance 40mm 1.6in +2.3= 3.90in wire 4.00in  
 wire C41 ( 93, 71) pad 18 distance 47mm 1.9in +2.3= 4.19in wire 4.50in  
 wire B32 ( 81, 84) pad 19 distance 38mm 1.5in +2.3= 3.84in wire 4.00in  
 wire D41 ( 93, 55) pad 20 distance 39mm 1.6in +2.3= 3.87in wire 4.00in  
 wire B31 ( 96, 95) pad 21 distance 37mm 1.5in +2.3= 3.78in wire 4.00in  
 wire D40 (107, 64) pad 22 distance 42mm 1.7in +2.3= 3.98in wire 4.00in  
 wire C40 (106, 80) pad 23 distance 34mm 1.3in +2.3= 3.65in wire 3.75in

Longest wire B36 at 113.4mm 4.47in Mean dist 102.4mm 4.03in

1 3.75-inch wires 10 4-inch wires 13 4.5-inch wires 0 5-inch wires 0 longer wires

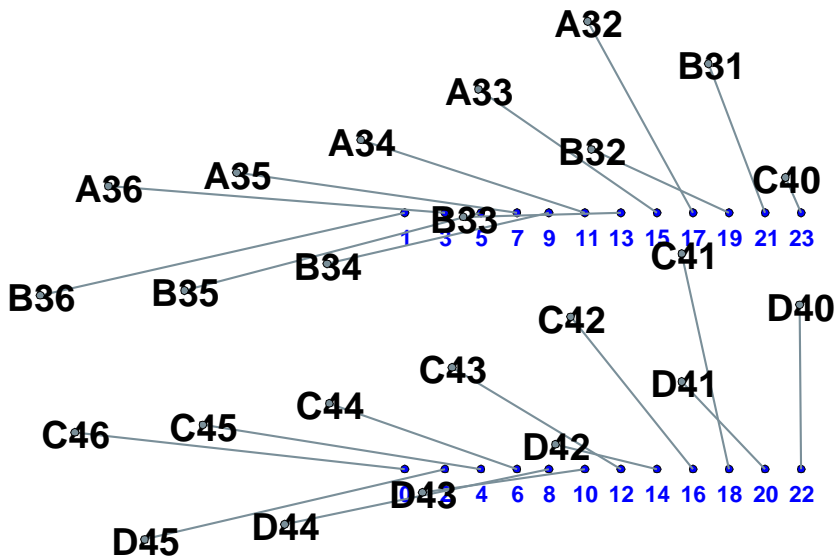

## A8

wire C53 ( 17, 52) pad 0 distance 51mm 2.0in +2.3= 4.33in wire 4.50in  
 wire B41 ( 21, 69) pad 1 distance 48mm 1.9in +2.3= 4.19in wire 4.50in  
 wire D52 ( 26, 38) pad 2 distance 47mm 1.8in +2.3= 4.17in wire 4.50in  
 wire A41 ( 29, 83) pad 3 distance 45mm 1.8in +2.3= 4.08in wire 4.50in  
 wire C52 ( 33, 52) pad 4 distance 47mm 1.9in +2.3= 4.19in wire 4.50in  
 wire B40 ( 39, 70) pad 5 distance 43mm 1.7in +2.3= 4.02in wire 4.50in  
 wire C51 ( 49, 55) pad 6 distance 39mm 1.5in +2.3= 3.87in wire 4.00in  
 wire A40 ( 45, 85) pad 7 distance 41mm 1.6in +2.3= 3.94in wire 4.00in  
 wire D51 ( 43, 40) pad 8 distance 46mm 1.8in +2.3= 4.13in wire 4.50in  
 wire B39 ( 57, 74) pad 9 distance 39mm 1.5in +2.3= 3.85in wire 4.00in  
 wire D50 ( 60, 44) pad 10 distance 39mm 1.5in +2.3= 3.85in wire 4.00in  
 wire A39 ( 60, 90) pad 11 distance 39mm 1.5in +2.3= 3.87in wire 4.00in  
 wire C50 ( 64, 59) pad 12 distance 45mm 1.8in +2.3= 4.09in wire 4.50in  
 wire B38 ( 73, 81) pad 13 distance 35mm 1.4in +2.3= 3.70in wire 3.75in  
 wire D49 ( 77, 49) pad 14 distance 38mm 1.5in +2.3= 3.81in wire 4.00in  
 wire A38 ( 74, 97) pad 15 distance 39mm 1.5in +2.3= 3.87in wire 4.00in  
 wire C49 ( 79, 65) pad 16 distance 47mm 1.8in +2.3= 4.16in wire 4.50in  
 wire A37 ( 88,106) pad 17 distance 41mm 1.6in +2.3= 3.95in wire 4.00in  
 wire D48 ( 93, 57) pad 18 distance 39mm 1.5in +2.3= 3.85in wire 4.00in  
 wire B37 ( 89, 91) pad 19 distance 36mm 1.4in +2.3= 3.74in wire 3.75in  
 wire C48 ( 93, 73) pad 20 distance 50mm 2.0in +2.3= 4.28in wire 4.50in  
 wire C47 (106, 82) pad 21 distance 33mm 1.3in +2.3= 3.62in wire 3.75in  
 wire D47 (108, 66) pad 22 distance 43mm 1.7in +2.3= 4.02in wire 4.50in  
 wire D46 (122, 78) pad 23 distance 35mm 1.4in +2.3= 3.69in wire 3.75in

Longest wire C53 at 110.0mm 4.33in Mean dist 100.8mm 3.97in

4 3.75-inch wires 9 4-inch wires 11 4.5-inch wires 0 5-inch wires 0 longer wires

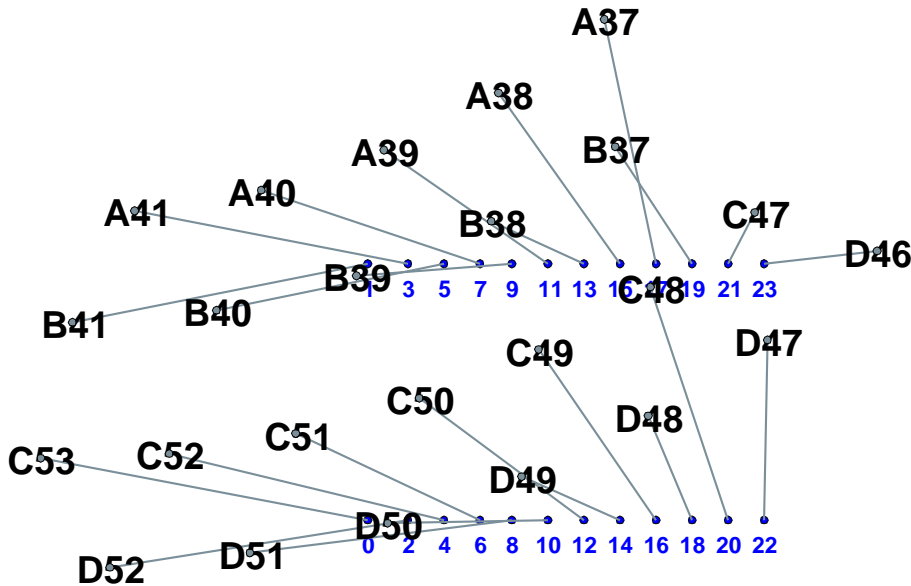



# B1

wire F4 ( 30, 58) pad 0 distance 45mm 1.8in +2.3= 4.10in wire 4.50in  
 wire E4 ( 25, 75) pad 1 distance 44mm 1.7in +2.3= 4.05in wire 4.50in  
 wire G3 ( 47, 36) pad 2 distance 35mm 1.4in +2.3= 3.71in wire 3.75in  
 wire E3 ( 42, 70) pad 3 distance 39mm 1.5in +2.3= 3.86in wire 4.00in  
 wire G2 ( 64, 34) pad 4 distance 33mm 1.3in +2.3= 3.63in wire 3.75in  
 wire F3 ( 48, 54) pad 5 distance 46mm 1.8in +2.3= 4.14in wire 4.50in  
 wire F2 ( 68, 52) pad 6 distance 33mm 1.3in +2.3= 3.63in wire 3.75in  
 wire E2 ( 60, 68) pad 7 distance 38mm 1.5in +2.3= 3.80in wire 4.00in  
 wire H2 ( 72, 19) pad 8 distance 38mm 1.5in +2.3= 3.81in wire 4.00in  
 wire E1 ( 77, 67) pad 9 distance 37mm 1.5in +2.3= 3.78in wire 4.00in  
 wire G1 ( 81, 34) pad 10 distance 33mm 1.3in +2.3= 3.63in wire 3.75in  
 wire H1 ( 91, 19) pad 12 distance 38mm 1.5in +2.3= 3.82in wire 4.00in  
 wire F1 ( 87, 52) pad 13 distance 46mm 1.8in +2.3= 4.12in wire 4.50in  
 wire G80 ( 98, 34) pad 14 distance 34mm 1.3in +2.3= 3.66in wire 3.75in  
 wire E66 ( 95, 67) pad 15 distance 37mm 1.5in +2.3= 3.78in wire 4.00in  
 wire F66 (106, 53) pad 16 distance 38mm 1.5in +2.3= 3.82in wire 4.00in  
 wire E65 (113, 70) pad 17 distance 39mm 1.5in +2.3= 3.87in wire 4.00in  
 wire G79 (116, 37) pad 18 distance 36mm 1.4in +2.3= 3.75in wire 3.75in  
 wire E64 (130, 74) pad 19 distance 45mm 1.8in +2.3= 4.10in wire 4.50in  
 wire F65 (125, 57) pad 20 distance 42mm 1.7in +2.3= 3.99in wire 4.00in  
 wire F64 (144, 62) pad 21 distance 53mm 2.1in +2.3= 4.42in wire 4.50in  
 wire G78 (133, 40) pad 22 distance 39mm 1.5in +2.3= 3.86in wire 4.00in  
 wire E63 (147, 79) pad 23 distance 48mm 1.9in +2.3= 4.22in wire 4.50in

Longest wire F64 at 112.2mm 4.42in Mean dist 98.9mm 3.89in

6 3.75-inch wires 10 4-inch wires 7 4.5-inch wires 0 5-inch wires 0 longer wires

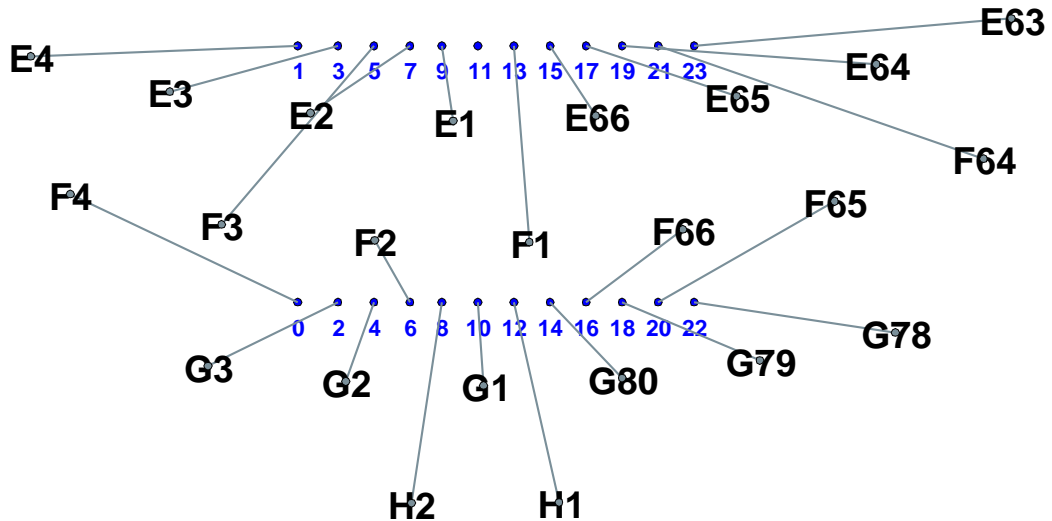

## B2

wire F11 ( 30, 57) pad 0 distance 45mm 1.8in +2.3= 4.09in wire 4.50in  
 wire E11 ( 25, 74) pad 1 distance 44mm 1.7in +2.3= 4.06in wire 4.50in  
 wire G12 ( 38, 38) pad 2 distance 39mm 1.5in +2.3= 3.85in wire 4.00in  
 wire E10 ( 42, 70) pad 3 distance 39mm 1.5in +2.3= 3.86in wire 4.00in  
 wire G11 ( 56, 35) pad 4 distance 34mm 1.3in +2.3= 3.67in wire 3.75in  
 wire F10 ( 49, 54) pad 5 distance 46mm 1.8in +2.3= 4.13in wire 4.50in  
 wire F9 ( 68, 52) pad 6 distance 33mm 1.3in +2.3= 3.63in wire 3.75in  
 wire E9 ( 60, 68) pad 7 distance 37mm 1.5in +2.3= 3.80in wire 4.00in  
 wire G10 ( 73, 34) pad 8 distance 33mm 1.3in +2.3= 3.63in wire 3.75in  
 wire E8 ( 77, 67) pad 9 distance 37mm 1.4in +2.3= 3.77in wire 4.00in  
 wire H10 ( 82, 19) pad 10 distance 37mm 1.5in +2.3= 3.80in wire 4.00in  
 wire F8 ( 87, 52) pad 12 distance 36mm 1.4in +2.3= 3.76in wire 4.00in  
 wire E7 ( 95, 68) pad 13 distance 38mm 1.5in +2.3= 3.80in wire 4.00in  
 wire G9 ( 90, 35) pad 14 distance 33mm 1.3in +2.3= 3.63in wire 3.75in  
 wire F7 (106, 54) pad 15 distance 47mm 1.8in +2.3= 4.16in wire 4.50in  
 wire H9 (100, 21) pad 16 distance 37mm 1.5in +2.3= 3.78in wire 4.00in  
 wire E6 (113, 71) pad 17 distance 39mm 1.5in +2.3= 3.86in wire 4.00in  
 wire G8 (107, 36) pad 18 distance 34mm 1.3in +2.3= 3.65in wire 3.75in  
 wire F6 (125, 58) pad 19 distance 48mm 1.9in +2.3= 4.21in wire 4.50in  
 wire G7 (124, 40) pad 20 distance 38mm 1.5in +2.3= 3.81in wire 4.00in  
 wire E5 (130, 75) pad 21 distance 41mm 1.6in +2.3= 3.93in wire 4.00in  
 wire G6 (141, 44) pad 22 distance 44mm 1.7in +2.3= 4.06in wire 4.50in  
 wire F5 (144, 63) pad 23 distance 49mm 1.9in +2.3= 4.26in wire 4.50in

Longest wire F5 at 108.3mm 4.26in Mean dist 98.5mm 3.88in

5 3.75-inch wires 11 4-inch wires 7 4.5-inch wires 0 5-inch wires 0 longer wires

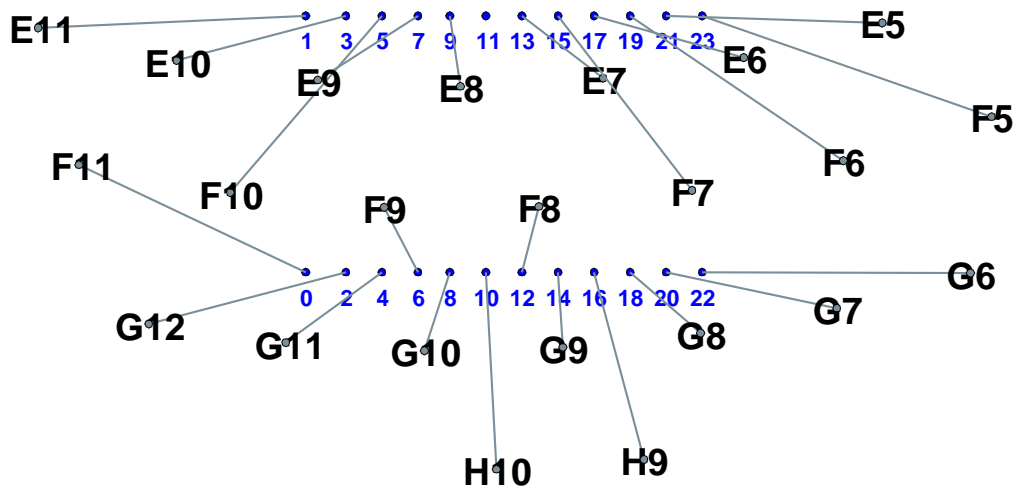

### B3

wire F18 ( 30, 57) pad 0 distance 45mm 1.8in +2.3= 4.08in wire 4.50in  
 wire F19 ( 11, 62) pad 1 distance 56mm 2.2in +2.3= 4.55in wire 5.00in  
 wire G20 ( 48, 36) pad 2 distance 35mm 1.4in +2.3= 3.70in wire 3.75in  
 wire E18 ( 24, 74) pad 3 distance 48mm 1.9in +2.3= 4.23in wire 4.50in  
 wire F17 ( 49, 54) pad 4 distance 40mm 1.6in +2.3= 3.88in wire 4.00in  
 wire E17 ( 42, 70) pad 5 distance 41mm 1.6in +2.3= 3.95in wire 4.00in  
 wire F16 ( 68, 53) pad 6 distance 33mm 1.3in +2.3= 3.64in wire 3.75in  
 wire E16 ( 60, 68) pad 7 distance 37mm 1.5in +2.3= 3.79in wire 4.00in  
 wire G19 ( 65, 35) pad 8 distance 35mm 1.4in +2.3= 3.68in wire 3.75in  
 wire E15 ( 77, 68) pad 9 distance 36mm 1.4in +2.3= 3.75in wire 3.75in  
 wire G18 ( 82, 36) pad 10 distance 33mm 1.3in +2.3= 3.63in wire 3.75in  
 wire F15 ( 88, 54) pad 12 distance 37mm 1.5in +2.3= 3.78in wire 4.00in  
 wire G17 (100, 37) pad 14 distance 34mm 1.3in +2.3= 3.66in wire 3.75in  
 wire F14 (107, 56) pad 16 distance 40mm 1.6in +2.3= 3.88in wire 4.00in  
 wire E14 ( 95, 70) pad 17 distance 36mm 1.4in +2.3= 3.72in wire 3.75in  
 wire G16 (116, 40) pad 18 distance 37mm 1.4in +2.3= 3.76in wire 4.00in  
 wire E13 (113, 73) pad 19 distance 36mm 1.4in +2.3= 3.76in wire 4.00in  
 wire F13 (126, 61) pad 20 distance 44mm 1.8in +2.3= 4.07in wire 4.50in  
 wire E12 (130, 78) pad 21 distance 40mm 1.6in +2.3= 3.91in wire 4.00in  
 wire G15 (133, 44) pad 22 distance 40mm 1.6in +2.3= 3.88in wire 4.00in  
 wire F12 (144, 67) pad 23 distance 48mm 1.9in +2.3= 4.22in wire 4.50in

Longest wire F19 at 115.5mm 4.55in Mean dist 98.6mm 3.88in

7 3.75-inch wires 9 4-inch wires 4 4.5-inch wires 1 5-inch wires 0 longer wires

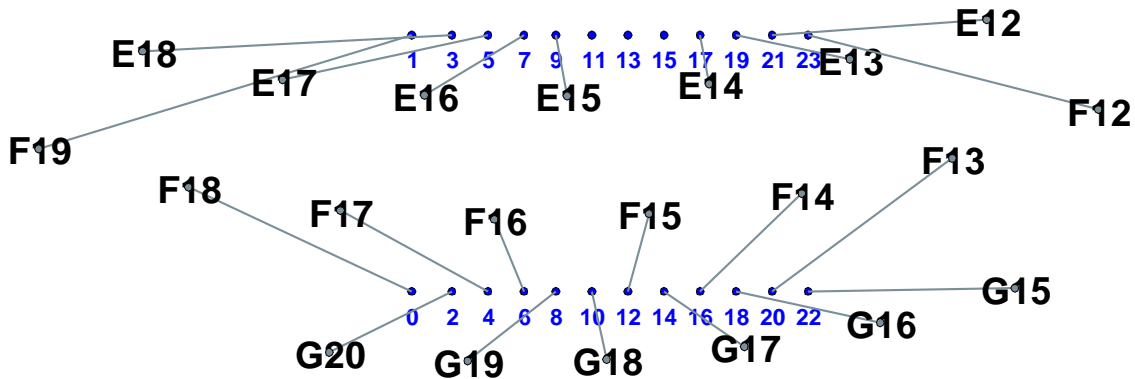

## B4

wire G31 ( 24, 41) pad 0 distance 44mm 1.7in +2.3= 4.07in wire 4.50in  
 wire E26 ( 25, 75) pad 1 distance 44mm 1.7in +2.3= 4.05in wire 4.50in  
 wire G30 ( 41, 37) pad 2 distance 38mm 1.5in +2.3= 3.80in wire 4.00in  
 wire F26 ( 30, 58) pad 3 distance 50mm 2.0in +2.3= 4.31in wire 4.50in  
 wire H30 ( 48, 21) pad 4 distance 41mm 1.6in +2.3= 3.92in wire 4.00in  
 wire E25 ( 42, 70) pad 5 distance 41mm 1.6in +2.3= 3.95in wire 4.00in  
 wire F24 ( 68, 52) pad 6 distance 33mm 1.3in +2.3= 3.63in wire 3.75in  
 wire F25 ( 48, 54) pad 7 distance 49mm 1.9in +2.3= 4.24in wire 4.50in  
 wire G29 ( 58, 35) pad 8 distance 37mm 1.5in +2.3= 3.78in wire 4.00in  
 wire E24 ( 60, 68) pad 9 distance 39mm 1.6in +2.3= 3.88in wire 4.00in  
 wire G28 ( 76, 34) pad 10 distance 33mm 1.3in +2.3= 3.64in wire 3.75in  
 wire E23 ( 78, 67) pad 11 distance 37mm 1.5in +2.3= 3.78in wire 4.00in  
 wire F23 ( 87, 52) pad 12 distance 36mm 1.4in +2.3= 3.74in wire 3.75in  
 wire G27 ( 93, 34) pad 14 distance 33mm 1.3in +2.3= 3.63in wire 3.75in  
 wire F22 (106, 53) pad 16 distance 38mm 1.5in +2.3= 3.82in wire 4.00in  
 wire E22 ( 95, 67) pad 17 distance 37mm 1.4in +2.3= 3.76in wire 4.00in  
 wire G26 (110, 36) pad 18 distance 34mm 1.3in +2.3= 3.67in wire 3.75in  
 wire E21 (113, 70) pad 19 distance 38mm 1.5in +2.3= 3.80in wire 4.00in  
 wire F21 (125, 57) pad 20 distance 42mm 1.7in +2.3= 3.99in wire 4.00in  
 wire E20 (130, 74) pad 21 distance 41mm 1.6in +2.3= 3.94in wire 4.00in  
 wire F20 (144, 62) pad 22 distance 51mm 2.0in +2.3= 4.34in wire 4.50in  
 wire E19 (147, 80) pad 23 distance 48mm 1.9in +2.3= 4.22in wire 4.50in

Longest wire F20 at 110.2mm 4.34in Mean dist 99.3mm 3.91in

5 3.75-inch wires 11 4-inch wires 6 4.5-inch wires 0 5-inch wires 0 longer wires

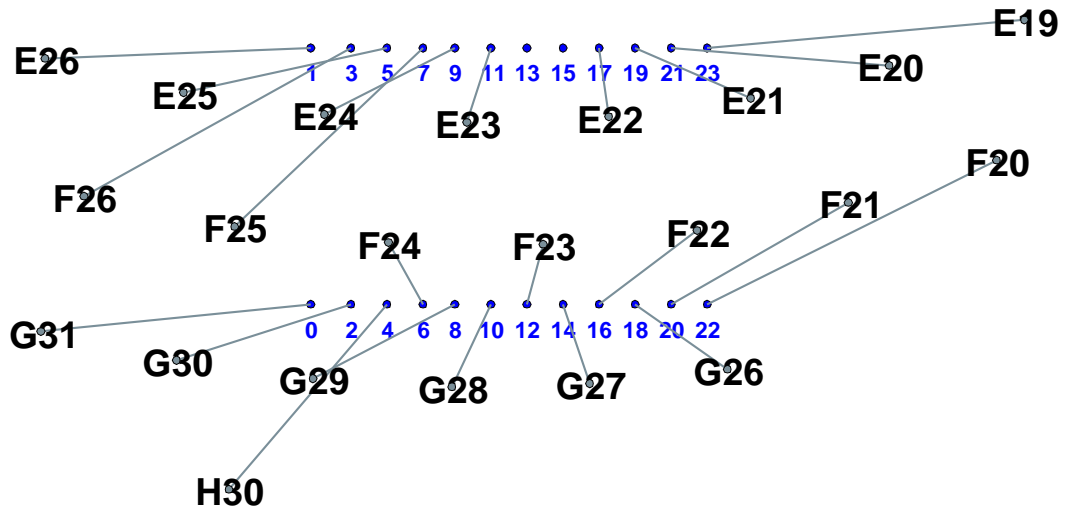

## B5

wire F33 ( 30, 58) pad 0 distance 45mm 1.8in +2.3= 4.09in wire 4.50in  
 wire E33 ( 25, 75) pad 1 distance 44mm 1.7in +2.3= 4.05in wire 4.50in  
 wire G39 ( 32, 39) pad 2 distance 42mm 1.7in +2.3= 3.99in wire 4.00in  
 wire E32 ( 42, 70) pad 3 distance 39mm 1.5in +2.3= 3.85in wire 4.00in  
 wire G38 ( 49, 36) pad 4 distance 36mm 1.4in +2.3= 3.75in wire 3.75in  
 wire E31 ( 60, 68) pad 5 distance 36mm 1.4in +2.3= 3.75in wire 3.75in  
 wire F32 ( 48, 54) pad 6 distance 39mm 1.5in +2.3= 3.87in wire 4.00in  
 wire H38 ( 56, 20) pad 8 distance 42mm 1.6in +2.3= 3.96in wire 4.00in  
 wire G37 ( 67, 34) pad 10 distance 36mm 1.4in +2.3= 3.73in wire 3.75in  
 wire E30 ( 78, 67) pad 11 distance 37mm 1.5in +2.3= 3.78in wire 4.00in  
 wire F31 ( 68, 52) pad 12 distance 40mm 1.6in +2.3= 3.90in wire 4.00in  
 wire G36 ( 84, 34) pad 14 distance 34mm 1.3in +2.3= 3.66in wire 3.75in  
 wire F30 ( 87, 51) pad 16 distance 37mm 1.5in +2.3= 3.78in wire 4.00in  
 wire E29 ( 95, 67) pad 17 distance 37mm 1.4in +2.3= 3.76in wire 4.00in  
 wire G35 (101, 35) pad 18 distance 33mm 1.3in +2.3= 3.63in wire 3.75in  
 wire E28 (113, 70) pad 19 distance 38mm 1.5in +2.3= 3.80in wire 4.00in  
 wire F29 (106, 53) pad 20 distance 36mm 1.4in +2.3= 3.75in wire 3.75in  
 wire E27 (130, 74) pad 21 distance 41mm 1.6in +2.3= 3.95in wire 4.00in  
 wire F28 (125, 56) pad 22 distance 40mm 1.6in +2.3= 3.88in wire 4.00in  
 wire F27 (144, 62) pad 23 distance 50mm 2.0in +2.3= 4.29in wire 4.50in

Longest wire F27 at 109.0mm 4.29in Mean dist 98.1mm 3.86in

6 3.75-inch wires 11 4-inch wires 3 4.5-inch wires 0 5-inch wires 0 longer wires

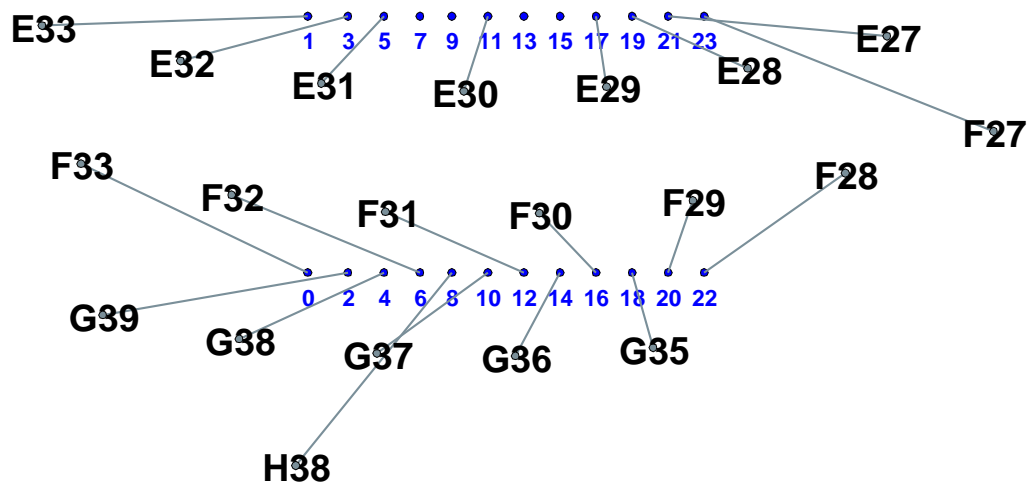

## B6

wire F40 ( 30, 57) pad 0 distance 45mm 1.8in +2.3= 4.09in wire 4.50in  
 wire E40 ( 25, 74) pad 1 distance 44mm 1.7in +2.3= 4.06in wire 4.50in  
 wire G47 ( 41, 37) pad 2 distance 38mm 1.5in +2.3= 3.80in wire 4.00in  
 wire E39 ( 42, 70) pad 3 distance 39mm 1.5in +2.3= 3.86in wire 4.00in  
 wire G46 ( 58, 35) pad 4 distance 34mm 1.3in +2.3= 3.65in wire 3.75in  
 wire F39 ( 49, 54) pad 5 distance 46mm 1.8in +2.3= 4.14in wire 4.50in  
 wire F38 ( 68, 52) pad 6 distance 33mm 1.3in +2.3= 3.63in wire 3.75in  
 wire E38 ( 60, 68) pad 7 distance 37mm 1.5in +2.3= 3.80in wire 4.00in  
 wire H46 ( 66, 20) pad 8 distance 38mm 1.5in +2.3= 3.83in wire 4.00in  
 wire G45 ( 75, 34) pad 10 distance 33mm 1.3in +2.3= 3.64in wire 3.75in  
 wire E37 ( 77, 67) pad 11 distance 37mm 1.4in +2.3= 3.77in wire 4.00in  
 wire H45 ( 85, 19) pad 12 distance 37mm 1.5in +2.3= 3.80in wire 4.00in  
 wire F37 ( 87, 52) pad 14 distance 36mm 1.4in +2.3= 3.76in wire 4.00in  
 wire G44 ( 93, 35) pad 16 distance 33mm 1.3in +2.3= 3.63in wire 3.75in  
 wire E36 ( 95, 68) pad 17 distance 36mm 1.4in +2.3= 3.75in wire 3.75in  
 wire F36 (106, 54) pad 18 distance 37mm 1.5in +2.3= 3.78in wire 4.00in  
 wire E35 (113, 71) pad 19 distance 37mm 1.5in +2.3= 3.79in wire 4.00in  
 wire G43 (110, 37) pad 20 distance 33mm 1.3in +2.3= 3.63in wire 3.75in  
 wire F35 (125, 58) pad 21 distance 45mm 1.8in +2.3= 4.09in wire 4.50in  
 wire G42 (127, 40) pad 22 distance 36mm 1.4in +2.3= 3.75in wire 3.75in  
 wire E34 (130, 75) pad 23 distance 38mm 1.5in +2.3= 3.83in wire 4.00in

Longest wire F39 at 105.1mm 4.14in Mean dist 96.8mm 3.81in

7 3.75-inch wires 10 4-inch wires 4 4.5-inch wires 0 5-inch wires 0 longer wires

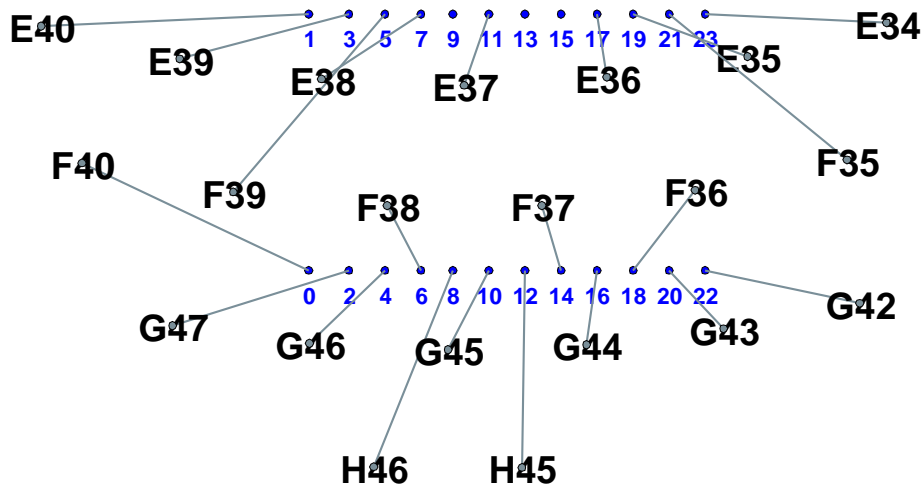

## B7

wire F48 ( 30, 58) pad 0 distance 45mm 1.8in +2.3= 4.10in wire 4.50in  
 wire E48 ( 25, 75) pad 1 distance 44mm 1.7in +2.3= 4.05in wire 4.50in  
 wire F47 ( 48, 54) pad 2 distance 38mm 1.5in +2.3= 3.82in wire 4.00in  
 wire E47 ( 42, 70) pad 3 distance 39mm 1.5in +2.3= 3.85in wire 4.00in  
 wire G56 ( 53, 35) pad 4 distance 35mm 1.4in +2.3= 3.70in wire 3.75in  
 wire E46 ( 60, 68) pad 5 distance 36mm 1.4in +2.3= 3.75in wire 3.75in  
 wire F46 ( 68, 52) pad 6 distance 33mm 1.3in +2.3= 3.63in wire 3.75in  
 wire G55 ( 70, 34) pad 8 distance 34mm 1.3in +2.3= 3.64in wire 3.75in  
 wire E45 ( 77, 67) pad 9 distance 37mm 1.5in +2.3= 3.77in wire 4.00in  
 wire F45 ( 87, 52) pad 10 distance 37mm 1.4in +2.3= 3.77in wire 4.00in  
 wire G54 ( 87, 34) pad 12 distance 33mm 1.3in +2.3= 3.63in wire 3.75in  
 wire E44 ( 95, 67) pad 13 distance 38mm 1.5in +2.3= 3.81in wire 4.00in  
 wire G53 (104, 35) pad 14 distance 36mm 1.4in +2.3= 3.73in wire 3.75in  
 wire E43 (113, 70) pad 15 distance 42mm 1.7in +2.3= 3.99in wire 4.00in  
 wire F44 (106, 53) pad 16 distance 38mm 1.5in +2.3= 3.83in wire 4.00in  
 wire F43 (125, 57) pad 17 distance 51mm 2.0in +2.3= 4.34in wire 4.50in  
 wire H53 (115, 22) pad 18 distance 39mm 1.6in +2.3= 3.88in wire 4.00in  
 wire E42 (130, 74) pad 19 distance 45mm 1.8in +2.3= 4.09in wire 4.50in  
 wire G52 (121, 38) pad 20 distance 36mm 1.4in +2.3= 3.76in wire 4.00in  
 wire F42 (144, 62) pad 21 distance 53mm 2.1in +2.3= 4.42in wire 4.50in  
 wire G51 (138, 42) pad 22 distance 42mm 1.7in +2.3= 3.99in wire 4.00in  
 wire E41 (147, 80) pad 23 distance 48mm 1.9in +2.3= 4.22in wire 4.50in

Longest wire F42 at 112.1mm 4.42in Mean dist 99.0mm 3.90in

6 3.75-inch wires 10 4-inch wires 6 4.5-inch wires 0 5-inch wires 0 longer wires

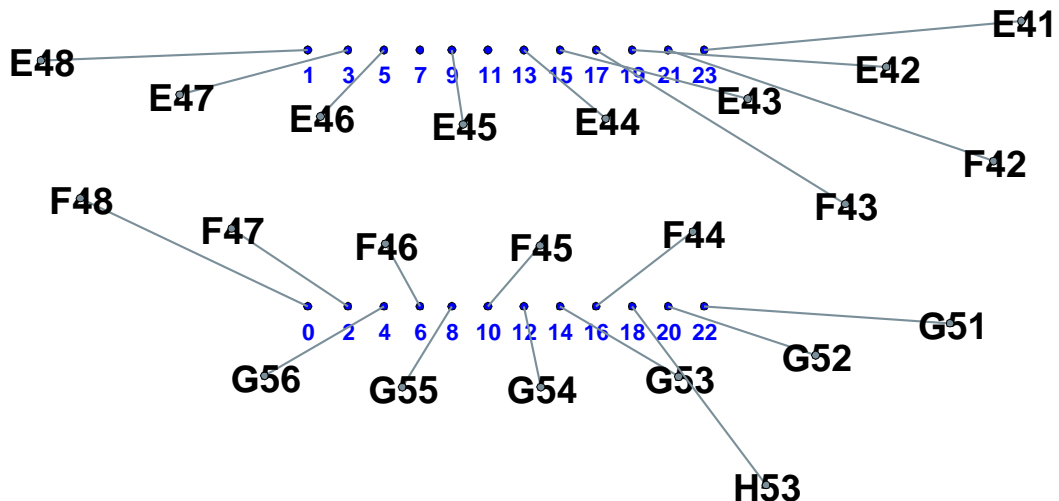

## B8

wire F55 ( 30, 58) pad 0 distance 45mm 1.8in +2.3= 4.09in wire 4.50in  
 wire E55 ( 25, 75) pad 1 distance 44mm 1.7in +2.3= 4.05in wire 4.50in  
 wire G66 ( 27, 40) pad 2 distance 46mm 1.8in +2.3= 4.13in wire 4.50in  
 wire E54 ( 42, 70) pad 3 distance 39mm 1.5in +2.3= 3.85in wire 4.00in  
 wire G65 ( 44, 37) pad 4 distance 39mm 1.5in +2.3= 3.85in wire 4.00in  
 wire F54 ( 49, 54) pad 5 distance 46mm 1.8in +2.3= 4.14in wire 4.50in  
 wire F53 ( 68, 52) pad 6 distance 33mm 1.3in +2.3= 3.63in wire 3.75in  
 wire E53 ( 60, 68) pad 7 distance 38mm 1.5in +2.3= 3.80in wire 4.00in  
 wire G64 ( 61, 35) pad 8 distance 36mm 1.4in +2.3= 3.74in wire 3.75in  
 wire E52 ( 77, 67) pad 9 distance 37mm 1.4in +2.3= 3.77in wire 4.00in  
 wire G63 ( 78, 34) pad 10 distance 33mm 1.3in +2.3= 3.63in wire 3.75in  
 wire F52 ( 87, 52) pad 12 distance 36mm 1.4in +2.3= 3.75in wire 3.75in  
 wire E51 ( 95, 68) pad 13 distance 38mm 1.5in +2.3= 3.81in wire 4.00in  
 wire G62 ( 96, 35) pad 14 distance 33mm 1.3in +2.3= 3.64in wire 3.75in  
 wire F51 (106, 54) pad 15 distance 47mm 1.9in +2.3= 4.17in wire 4.50in  
 wire G61 (113, 37) pad 16 distance 37mm 1.5in +2.3= 3.78in wire 4.00in  
 wire E50 (113, 70) pad 17 distance 39mm 1.5in +2.3= 3.86in wire 4.00in  
 wire G60 (130, 40) pad 18 distance 44mm 1.7in +2.3= 4.05in wire 4.50in  
 wire F50 (125, 57) pad 19 distance 48mm 1.9in +2.3= 4.22in wire 4.50in  
 wire H60 (142, 28) pad 20 distance 50mm 2.0in +2.3= 4.29in wire 4.50in  
 wire E49 (130, 74) pad 21 distance 41mm 1.6in +2.3= 3.94in wire 4.00in  
 wire G59 (146, 45) pad 22 distance 48mm 1.9in +2.3= 4.21in wire 4.50in  
 wire F49 (144, 63) pad 23 distance 50mm 2.0in +2.3= 4.28in wire 4.50in

Longest wire H60 at 109.0mm 4.29in Mean dist 100.1mm 3.94in

5 3.75-inch wires 8 4-inch wires 10 4.5-inch wires 0 5-inch wires 0 longer wires

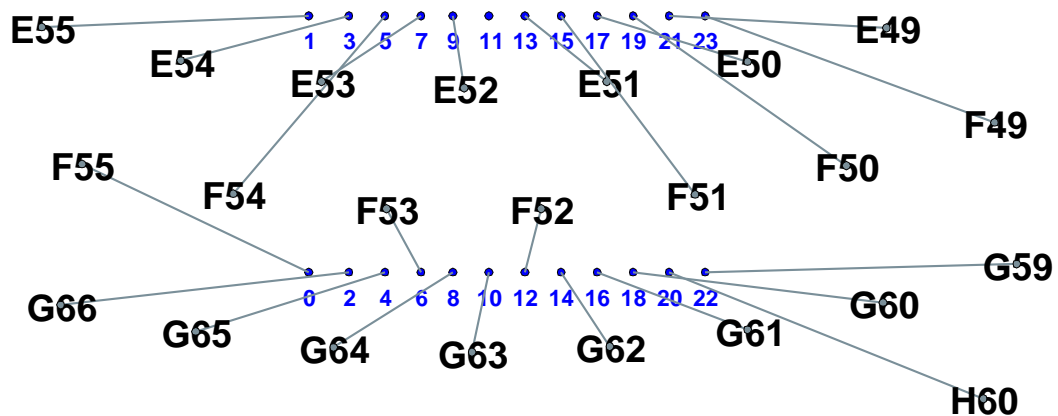



## B9

wire F62 ( 30, 57) pad 0 distance 45mm 1.8in +2.3= 4.09in wire 4.50in  
 wire E62 ( 24, 74) pad 1 distance 44mm 1.7in +2.3= 4.06in wire 4.50in  
 wire G74 ( 36, 38) pad 2 distance 41mm 1.6in +2.3= 3.92in wire 4.00in  
 wire E61 ( 42, 70) pad 3 distance 39mm 1.5in +2.3= 3.85in wire 4.00in  
 wire G73 ( 53, 36) pad 4 distance 35mm 1.4in +2.3= 3.70in wire 3.75in  
 wire E60 ( 60, 68) pad 5 distance 36mm 1.4in +2.3= 3.74in wire 3.75in  
 wire F61 ( 49, 54) pad 6 distance 39mm 1.5in +2.3= 3.87in wire 4.00in  
 wire F60 ( 68, 52) pad 8 distance 37mm 1.5in +2.3= 3.78in wire 4.00in  
 wire E59 ( 77, 68) pad 9 distance 36mm 1.4in +2.3= 3.76in wire 4.00in  
 wire G72 ( 70, 35) pad 10 distance 35mm 1.4in +2.3= 3.68in wire 3.75in  
 wire G71 ( 87, 35) pad 12 distance 33mm 1.3in +2.3= 3.63in wire 3.75in  
 wire F59 ( 87, 53) pad 14 distance 37mm 1.4in +2.3= 3.77in wire 4.00in  
 wire G70 (104, 36) pad 16 distance 34mm 1.3in +2.3= 3.66in wire 3.75in  
 wire E58 ( 95, 69) pad 17 distance 36mm 1.4in +2.3= 3.74in wire 3.75in  
 wire F58 (106, 55) pad 18 distance 37mm 1.5in +2.3= 3.79in wire 4.00in  
 wire E57 (113, 71) pad 19 distance 37mm 1.5in +2.3= 3.77in wire 4.00in  
 wire G69 (121, 40) pad 20 distance 36mm 1.4in +2.3= 3.76in wire 4.00in  
 wire E56 (130, 76) pad 21 distance 41mm 1.6in +2.3= 3.93in wire 4.00in  
 wire F57 (125, 59) pad 22 distance 41mm 1.6in +2.3= 3.92in wire 4.00in  
 wire F56 (144, 64) pad 23 distance 49mm 1.9in +2.3= 4.25in wire 4.50in

Longest wire F56 at 108.0mm 4.25in Mean dist 97.4mm 3.83in

6 3.75-inch wires 11 4-inch wires 3 4.5-inch wires 0 5-inch wires 0 longer wires

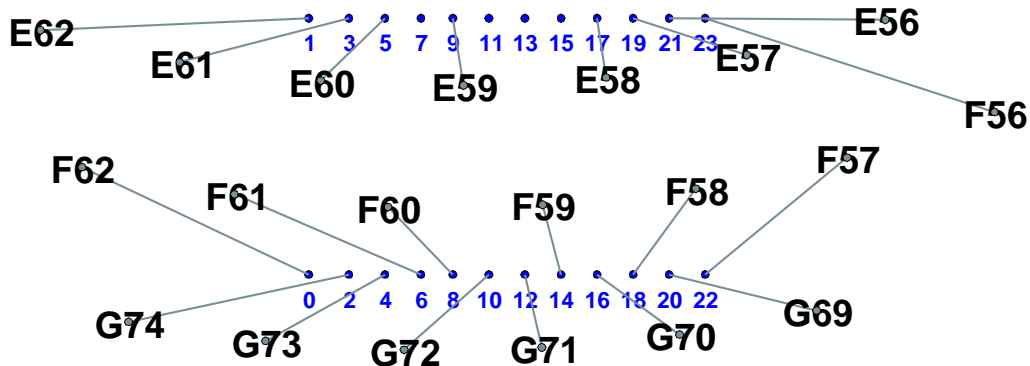

# C1

wire J8 ( 36, 40) pad 0 distance 38mm 1.5in +2.3= 3.80in wire 4.00in  
 wire I10 ( 14, 60) pad 1 distance 55mm 2.2in +2.3= 4.50in wire 4.50in  
 wire I8 ( 47, 52) pad 2 distance 38mm 1.5in +2.3= 3.82in wire 4.00in  
 wire I9 ( 30, 56) pad 3 distance 51mm 2.0in +2.3= 4.33in wire 4.50in  
 wire J7 ( 54, 37) pad 4 distance 35mm 1.4in +2.3= 3.68in wire 3.75in  
 wire H8 ( 35, 72) pad 5 distance 45mm 1.8in +2.3= 4.10in wire 4.50in  
 wire I7 ( 64, 50) pad 6 distance 33mm 1.3in +2.3= 3.64in wire 3.75in  
 wire H7 ( 53, 68) pad 7 distance 39mm 1.6in +2.3= 3.87in wire 4.00in  
 wire J6 ( 72, 35) pad 8 distance 33mm 1.3in +2.3= 3.63in wire 3.75in  
 wire H6 ( 72, 66) pad 9 distance 37mm 1.5in +2.3= 3.78in wire 4.00in  
 wire I6 ( 81, 49) pad 10 distance 35mm 1.4in +2.3= 3.71in wire 3.75in  
 wire G5 ( 81, 81) pad 11 distance 33mm 1.3in +2.3= 3.63in wire 3.75in  
 wire J5 ( 90, 35) pad 12 distance 33mm 1.3in +2.3= 3.64in wire 3.75in  
 wire H5 ( 90, 66) pad 13 distance 37mm 1.5in +2.3= 3.80in wire 4.00in  
 wire I5 ( 98, 50) pad 14 distance 36mm 1.4in +2.3= 3.74in wire 3.75in  
 wire G4 ( 98, 81) pad 15 distance 34mm 1.3in +2.3= 3.67in wire 3.75in  
 wire J4 (108, 36) pad 16 distance 35mm 1.4in +2.3= 3.70in wire 3.75in  
 wire H4 (108, 67) pad 17 distance 39mm 1.5in +2.3= 3.85in wire 4.00in  
 wire I4 (115, 51) pad 18 distance 38mm 1.5in +2.3= 3.82in wire 4.00in  
 wire H3 (127, 69) pad 19 distance 44mm 1.7in +2.3= 4.06in wire 4.50in  
 wire J3 (126, 38) pad 20 distance 38mm 1.5in +2.3= 3.83in wire 4.00in  
 wire I3 (132, 54) pad 21 distance 50mm 2.0in +2.3= 4.30in wire 4.50in  
 wire J2 (143, 41) pad 22 distance 45mm 1.8in +2.3= 4.11in wire 4.50in  
 wire I2 (148, 57) pad 23 distance 55mm 2.2in +2.3= 4.49in wire 4.50in

Longest wire I10 at 114.2mm 4.50in Mean dist 98.9mm 3.90in

9 3.75-inch wires 8 4-inch wires 7 4.5-inch wires 0 5-inch wires 0 longer wires

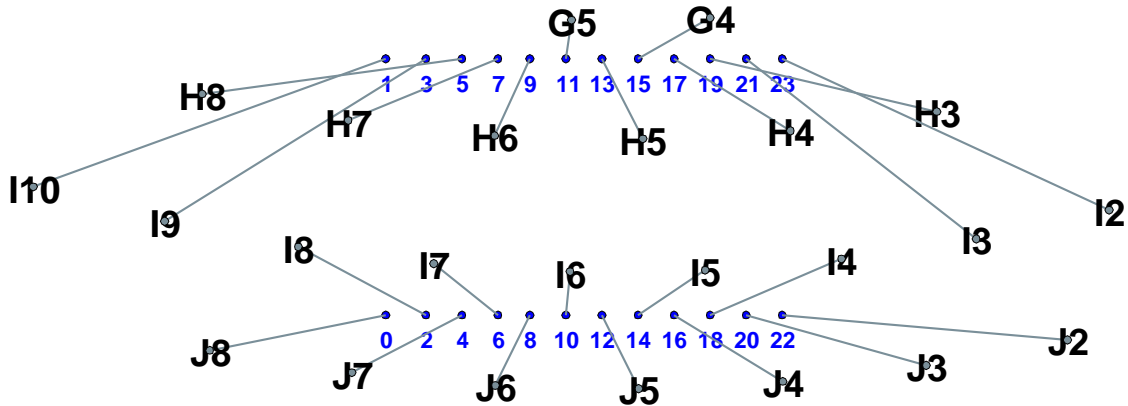

## C2

wire J17 ( 21, 40) pad 0 distance 47mm 1.8in +2.3= 4.16in wire 4.50in  
 wire I18 ( 16, 56) pad 1 distance 55mm 2.2in +2.3= 4.50in wire 5.00in  
 wire I17 ( 33, 52) pad 2 distance 45mm 1.8in +2.3= 4.08in wire 4.50in  
 wire H16 ( 17, 73) pad 3 distance 54mm 2.1in +2.3= 4.46in wire 4.50in  
 wire J16 ( 39, 37) pad 4 distance 42mm 1.6in +2.3= 3.96in wire 4.00in  
 wire H15 ( 35, 69) pad 5 distance 46mm 1.8in +2.3= 4.13in wire 4.50in  
 wire I16 ( 49, 50) pad 6 distance 38mm 1.5in +2.3= 3.84in wire 4.00in  
 wire G14 ( 46, 82) pad 7 distance 40mm 1.6in +2.3= 3.90in wire 4.00in  
 wire J15 ( 56, 34) pad 8 distance 38mm 1.5in +2.3= 3.82in wire 4.00in  
 wire H14 ( 53, 66) pad 9 distance 43mm 1.7in +2.3= 4.02in wire 4.50in  
 wire I15 ( 66, 48) pad 10 distance 37mm 1.5in +2.3= 3.80in wire 4.00in  
 wire G13 ( 63, 80) pad 11 distance 37mm 1.5in +2.3= 3.79in wire 4.00in  
 wire J14 ( 74, 33) pad 12 distance 35mm 1.4in +2.3= 3.70in wire 3.75in  
 wire H13 ( 71, 65) pad 13 distance 40mm 1.6in +2.3= 3.91in wire 4.00in  
 wire I14 ( 83, 48) pad 14 distance 36mm 1.4in +2.3= 3.72in wire 3.75in  
 wire H12 ( 90, 64) pad 15 distance 38mm 1.5in +2.3= 3.81in wire 4.00in  
 wire J13 ( 92, 34) pad 16 distance 33mm 1.3in +2.3= 3.64in wire 3.75in  
 wire I13 (100, 48) pad 17 distance 48mm 1.9in +2.3= 4.21in wire 4.50in  
 wire J12 (110, 35) pad 18 distance 34mm 1.4in +2.3= 3.68in wire 3.75in  
 wire H11 (108, 66) pad 19 distance 38mm 1.5in +2.3= 3.81in wire 4.00in  
 wire J11 (128, 38) pad 20 distance 40mm 1.6in +2.3= 3.89in wire 4.00in  
 wire I12 (117, 50) pad 21 distance 47mm 1.8in +2.3= 4.17in wire 4.50in  
 wire J10 (146, 41) pad 22 distance 47mm 1.9in +2.3= 4.18in wire 4.50in  
 wire I11 (134, 53) pad 23 distance 49mm 1.9in +2.3= 4.25in wire 4.50in

Longest wire I18 at 114.4mm 4.50in Mean dist 101.0mm 3.98in

4 3.75-inch wires 10 4-inch wires 9 4.5-inch wires 1 5-inch wires 0 longer wires

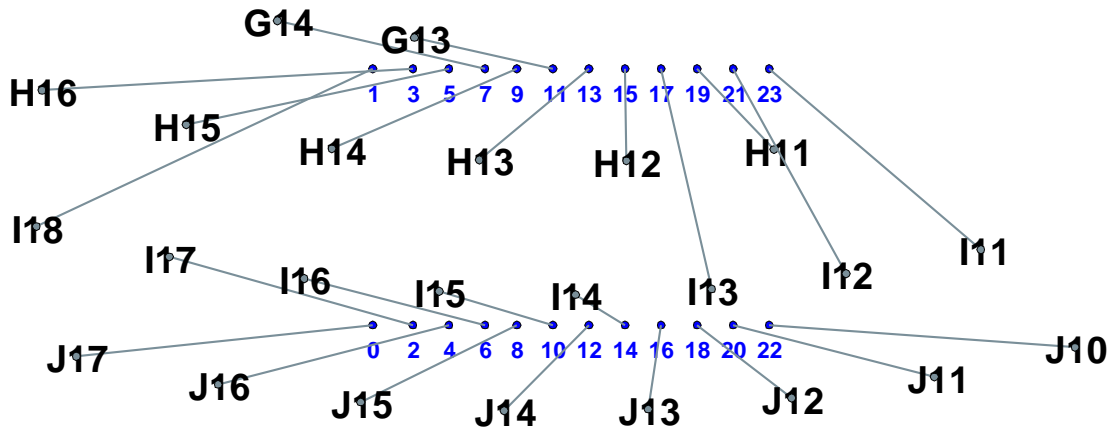

### C3

wire I26 ( 30, 56) pad 0 distance 44mm 1.7in +2.3= 4.05in wire 4.50in  
 wire G23 ( 24, 90) pad 1 distance 45mm 1.8in +2.3= 4.10in wire 4.50in  
 wire J25 ( 36, 40) pad 2 distance 40mm 1.6in +2.3= 3.91in wire 4.00in  
 wire H23 ( 28, 73) pad 3 distance 46mm 1.8in +2.3= 4.13in wire 4.50in  
 wire J24 ( 54, 37) pad 4 distance 35mm 1.4in +2.3= 3.68in wire 3.75in  
 wire G22 ( 40, 86) pad 5 distance 41mm 1.6in +2.3= 3.93in wire 4.00in  
 wire I25 ( 47, 52) pad 6 distance 40mm 1.6in +2.3= 3.89in wire 4.00in  
 wire H22 ( 46, 69) pad 7 distance 42mm 1.7in +2.3= 3.98in wire 4.00in  
 wire I24 ( 64, 50) pad 8 distance 37mm 1.5in +2.3= 3.79in wire 4.00in  
 wire G21 ( 58, 83) pad 9 distance 37mm 1.5in +2.3= 3.79in wire 4.00in  
 wire J23 ( 72, 35) pad 10 distance 34mm 1.3in +2.3= 3.66in wire 3.75in  
 wire H21 ( 65, 67) pad 11 distance 40mm 1.6in +2.3= 3.89in wire 4.00in  
 wire I23 ( 81, 50) pad 12 distance 36mm 1.4in +2.3= 3.72in wire 3.75in  
 wire H20 ( 83, 66) pad 13 distance 37mm 1.5in +2.3= 3.78in wire 4.00in  
 wire J22 ( 90, 35) pad 14 distance 33mm 1.3in +2.3= 3.63in wire 3.75in  
 wire I22 ( 98, 50) pad 16 distance 35mm 1.4in +2.3= 3.72in wire 3.75in  
 wire H19 (102, 67) pad 17 distance 37mm 1.5in +2.3= 3.79in wire 4.00in  
 wire J21 (108, 36) pad 18 distance 34mm 1.3in +2.3= 3.65in wire 3.75in  
 wire H18 (120, 69) pad 19 distance 41mm 1.6in +2.3= 3.93in wire 4.00in  
 wire I21 (115, 51) pad 20 distance 37mm 1.4in +2.3= 3.77in wire 4.00in  
 wire I20 (132, 54) pad 21 distance 50mm 2.0in +2.3= 4.29in wire 4.50in  
 wire J20 (126, 38) pad 22 distance 36mm 1.4in +2.3= 3.73in wire 3.75in  
 wire H17 (138, 72) pad 23 distance 43mm 1.7in +2.3= 4.03in wire 4.50in

Longest wire I20 at 109.0mm 4.29in Mean dist 98.1mm 3.86in

7 3.75-inch wires 11 4-inch wires 5 4.5-inch wires 0 5-inch wires 0 longer wires

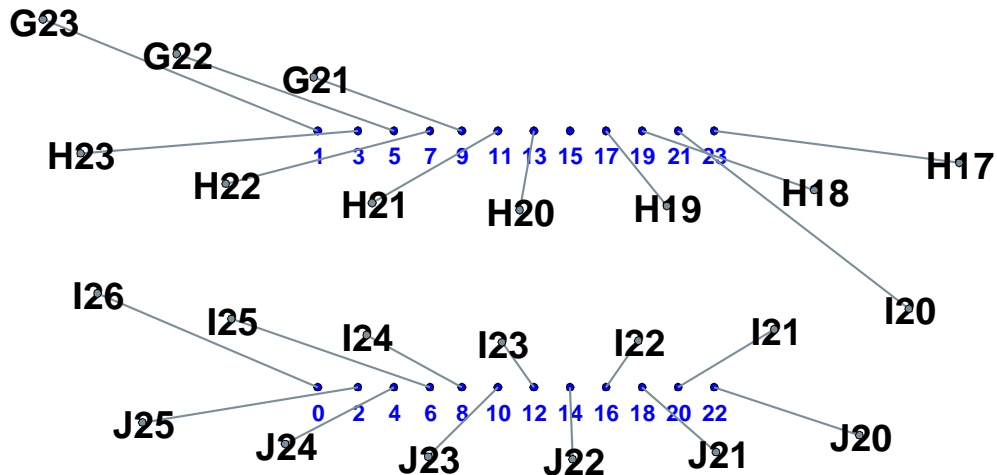

## C4

wire I34 ( 31, 55) pad 0 distance 43mm 1.7in +2.3= 4.03in wire 4.50in  
 wire H29 ( 44, 69) pad 1 distance 36mm 1.4in +2.3= 3.74in wire 3.75in  
 wire J33 ( 37, 39) pad 2 distance 40mm 1.6in +2.3= 3.89in wire 4.00in  
 wire I33 ( 48, 52) pad 3 distance 46mm 1.8in +2.3= 4.13in wire 4.50in  
 wire J32 ( 55, 37) pad 4 distance 34mm 1.4in +2.3= 3.67in wire 3.75in  
 wire H28 ( 63, 67) pad 5 distance 36mm 1.4in +2.3= 3.75in wire 3.75in  
 wire I32 ( 64, 50) pad 6 distance 33mm 1.3in +2.3= 3.64in wire 3.75in  
 wire J31 ( 72, 35) pad 8 distance 33mm 1.3in +2.3= 3.63in wire 3.75in  
 wire I31 ( 82, 50) pad 10 distance 35mm 1.4in +2.3= 3.72in wire 3.75in  
 wire H27 ( 81, 66) pad 11 distance 37mm 1.5in +2.3= 3.78in wire 4.00in  
 wire J30 ( 90, 35) pad 12 distance 33mm 1.3in +2.3= 3.64in wire 3.75in  
 wire I30 ( 98, 50) pad 14 distance 36mm 1.4in +2.3= 3.75in wire 4.00in  
 wire H26 (100, 67) pad 15 distance 38mm 1.5in +2.3= 3.82in wire 4.00in  
 wire J29 (108, 36) pad 16 distance 35mm 1.4in +2.3= 3.71in wire 3.75in  
 wire G25 (107, 83) pad 17 distance 35mm 1.4in +2.3= 3.69in wire 3.75in  
 wire I29 (115, 52) pad 18 distance 39mm 1.5in +2.3= 3.84in wire 4.00in  
 wire H25 (118, 69) pad 19 distance 40mm 1.6in +2.3= 3.88in wire 4.00in  
 wire I28 (132, 55) pad 20 distance 45mm 1.8in +2.3= 4.11in wire 4.50in  
 wire G24 (124, 85) pad 21 distance 37mm 1.5in +2.3= 3.79in wire 4.00in  
 wire I27 (149, 59) pad 22 distance 53mm 2.1in +2.3= 4.42in wire 4.50in  
 wire H24 (136, 73) pad 23 distance 42mm 1.7in +2.3= 3.97in wire 4.00in

Longest wire I27 at 112.2mm 4.42in Mean dist 97.5mm 3.84in

9 3.75-inch wires 8 4-inch wires 4 4.5-inch wires 0 5-inch wires 0 longer wires

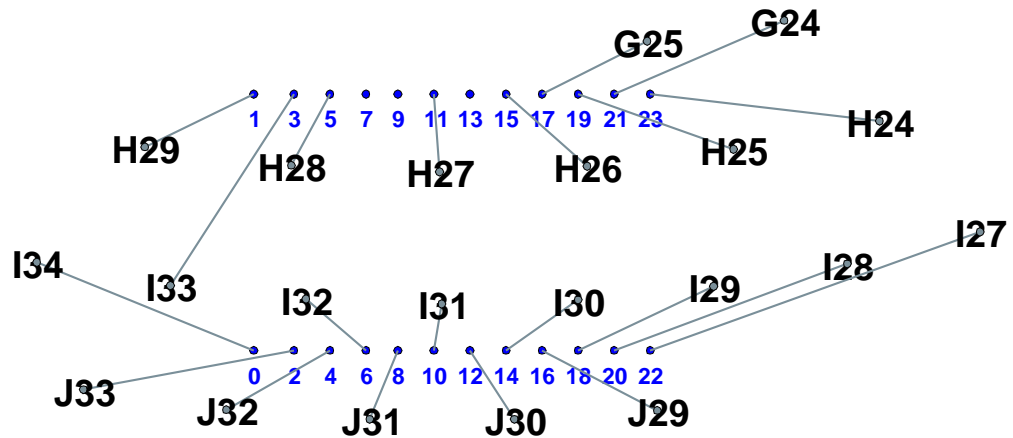

## C5

wire I42 ( 48, 54) pad 0 distance 37mm 1.4in +2.3= 3.76in wire 4.00in  
 wire I43 ( 31, 55) pad 1 distance 48mm 1.9in +2.3= 4.20in wire 4.50in  
 wire J41 ( 57, 39) pad 2 distance 33mm 1.3in +2.3= 3.63in wire 3.75in  
 wire H37 ( 38, 71) pad 3 distance 41mm 1.6in +2.3= 3.92in wire 4.00in  
 wire I41 ( 65, 54) pad 4 distance 36mm 1.4in +2.3= 3.76in wire 4.00in  
 wire H36 ( 57, 70) pad 5 distance 36mm 1.4in +2.3= 3.74in wire 3.75in  
 wire I40 ( 82, 55) pad 6 distance 36mm 1.4in +2.3= 3.74in wire 3.75in  
 wire H35 ( 75, 71) pad 7 distance 36mm 1.4in +2.3= 3.73in wire 3.75in  
 wire J40 ( 75, 39) pad 8 distance 33mm 1.3in +2.3= 3.63in wire 3.75in  
 wire G34 ( 83, 86) pad 9 distance 34mm 1.3in +2.3= 3.66in wire 3.75in  
 wire J39 ( 92, 41) pad 10 distance 36mm 1.4in +2.3= 3.72in wire 3.75in  
 wire H34 ( 94, 73) pad 11 distance 37mm 1.5in +2.3= 3.78in wire 4.00in  
 wire I39 ( 99, 57) pad 12 distance 41mm 1.6in +2.3= 3.94in wire 4.00in  
 wire G33 (100, 89) pad 13 distance 37mm 1.4in +2.3= 3.76in wire 4.00in  
 wire J38 (110, 44) pad 14 distance 39mm 1.5in +2.3= 3.85in wire 4.00in  
 wire H33 (112, 77) pad 15 distance 40mm 1.6in +2.3= 3.90in wire 4.00in  
 wire I38 (116, 60) pad 16 distance 45mm 1.8in +2.3= 4.09in wire 4.50in  
 wire G32 (116, 93) pad 17 distance 40mm 1.6in +2.3= 3.90in wire 4.00in  
 wire J37 (128, 49) pad 18 distance 44mm 1.7in +2.3= 4.05in wire 4.50in  
 wire H32 (129, 82) pad 19 distance 44mm 1.7in +2.3= 4.04in wire 4.50in  
 wire I37 (132, 65) pad 20 distance 50mm 2.0in +2.3= 4.29in wire 4.50in  
 wire H31 (147, 88) pad 21 distance 52mm 2.0in +2.3= 4.37in wire 4.50in  
 wire J36 (145, 54) pad 22 distance 49mm 1.9in +2.3= 4.25in wire 4.50in  
 wire I36 (148, 71) pad 23 distance 50mm 2.0in +2.3= 4.29in wire 4.50in

Longest wire H31 at 110.9mm 4.37in Mean dist 99.5mm 3.92in

7 3.75-inch wires 9 4-inch wires 8 4.5-inch wires 0 5-inch wires 0 longer wires

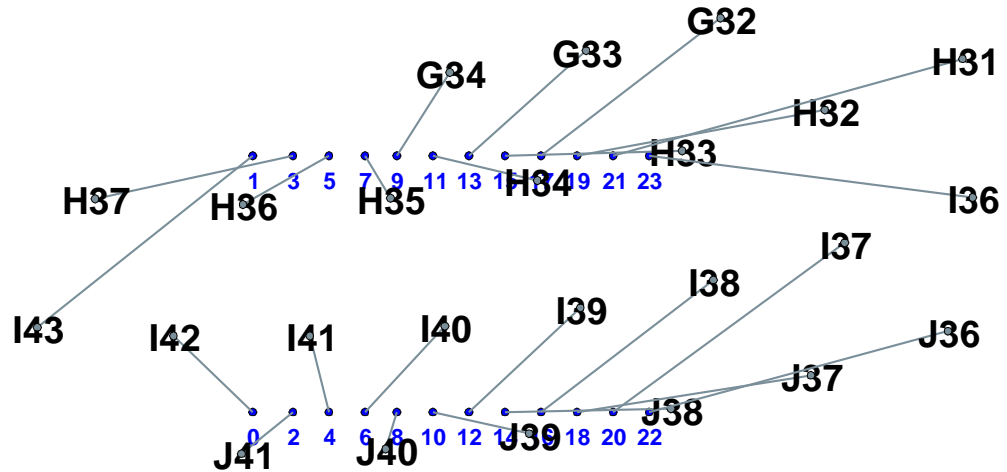

## C6

wire J50 ( 37, 39) pad 0 distance 37mm 1.5in +2.3= 3.78in wire 4.00in  
 wire I51 ( 31, 55) pad 1 distance 48mm 1.9in +2.3= 4.20in wire 4.50in  
 wire I50 ( 48, 52) pad 2 distance 37mm 1.5in +2.3= 3.80in wire 4.00in  
 wire H44 ( 38, 70) pad 3 distance 41mm 1.6in +2.3= 3.94in wire 4.00in  
 wire J49 ( 55, 36) pad 4 distance 34mm 1.3in +2.3= 3.67in wire 3.75in  
 wire H43 ( 56, 68) pad 5 distance 37mm 1.5in +2.3= 3.78in wire 4.00in  
 wire I49 ( 65, 50) pad 6 distance 33mm 1.3in +2.3= 3.64in wire 3.75in  
 wire J48 ( 73, 35) pad 8 distance 33mm 1.3in +2.3= 3.63in wire 3.75in  
 wire H42 ( 74, 66) pad 9 distance 37mm 1.5in +2.3= 3.78in wire 4.00in  
 wire I48 ( 82, 50) pad 10 distance 35mm 1.4in +2.3= 3.72in wire 3.75in  
 wire G41 ( 84, 81) pad 11 distance 33mm 1.3in +2.3= 3.63in wire 3.75in  
 wire J47 ( 91, 35) pad 12 distance 34mm 1.3in +2.3= 3.64in wire 3.75in  
 wire F34 ( 89, 99) pad 13 distance 37mm 1.5in +2.3= 3.77in wire 4.00in  
 wire I47 ( 99, 50) pad 14 distance 36mm 1.4in +2.3= 3.76in wire 4.00in  
 wire H41 ( 93, 66) pad 15 distance 37mm 1.5in +2.3= 3.78in wire 4.00in  
 wire J46 (109, 37) pad 16 distance 35mm 1.4in +2.3= 3.72in wire 3.75in  
 wire G40 (101, 82) pad 17 distance 33mm 1.3in +2.3= 3.64in wire 3.75in  
 wire I46 (116, 52) pad 18 distance 39mm 1.5in +2.3= 3.85in wire 4.00in  
 wire H40 (111, 68) pad 19 distance 38mm 1.5in +2.3= 3.80in wire 4.00in  
 wire J45 (127, 39) pad 20 distance 39mm 1.5in +2.3= 3.86in wire 4.00in  
 wire H39 (129, 71) pad 21 distance 41mm 1.6in +2.3= 3.95in wire 4.00in  
 wire I45 (132, 55) pad 22 distance 42mm 1.7in +2.3= 3.98in wire 4.00in  
 wire I44 (149, 59) pad 23 distance 55mm 2.1in +2.3= 4.47in wire 4.50in

Longest wire I44 at 113.6mm 4.47in Mean dist 96.9mm 3.82in

8 3.75-inch wires 13 4-inch wires 2 4.5-inch wires 0 5-inch wires 0 longer wires

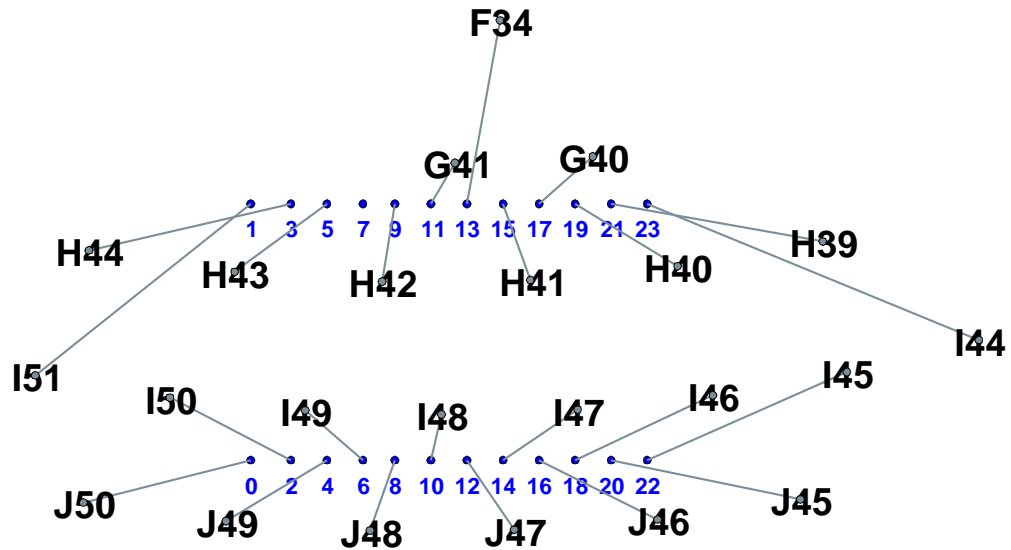

## C7

wire J59 ( 36, 40) pad 0 distance 38mm 1.5in +2.3= 3.81in wire 4.00in  
 wire I60 ( 30, 56) pad 1 distance 47mm 1.9in +2.3= 4.19in wire 4.50in  
 wire I59 ( 47, 52) pad 2 distance 38mm 1.5in +2.3= 3.81in wire 4.00in  
 wire H52 ( 33, 72) pad 3 distance 43mm 1.7in +2.3= 4.02in wire 4.50in  
 wire J58 ( 53, 36) pad 4 distance 35mm 1.4in +2.3= 3.69in wire 3.75in  
 wire H51 ( 51, 68) pad 5 distance 38mm 1.5in +2.3= 3.82in wire 4.00in  
 wire H50 ( 69, 66) pad 6 distance 38mm 1.5in +2.3= 3.80in wire 4.00in  
 wire G50 ( 62, 82) pad 7 distance 34mm 1.3in +2.3= 3.65in wire 3.75in  
 wire I58 ( 64, 50) pad 8 distance 37mm 1.5in +2.3= 3.78in wire 4.00in  
 wire F41 ( 78, 98) pad 9 distance 36mm 1.4in +2.3= 3.75in wire 4.00in  
 wire J57 ( 71, 35) pad 10 distance 34mm 1.3in +2.3= 3.67in wire 3.75in  
 wire G49 ( 79, 80) pad 11 distance 33mm 1.3in +2.3= 3.63in wire 3.75in  
 wire I57 ( 81, 49) pad 12 distance 35mm 1.4in +2.3= 3.71in wire 3.75in  
 wire H49 ( 88, 65) pad 13 distance 38mm 1.5in +2.3= 3.81in wire 4.00in  
 wire J56 ( 89, 34) pad 14 distance 33mm 1.3in +2.3= 3.63in wire 3.75in  
 wire G48 ( 97, 80) pad 15 distance 34mm 1.3in +2.3= 3.65in wire 3.75in  
 wire I56 ( 98, 48) pad 16 distance 35mm 1.4in +2.3= 3.70in wire 3.75in  
 wire H48 (106, 66) pad 17 distance 39mm 1.5in +2.3= 3.85in wire 4.00in  
 wire J55 (107, 34) pad 18 distance 34mm 1.3in +2.3= 3.65in wire 3.75in  
 wire H47 (125, 68) pad 19 distance 43mm 1.7in +2.3= 4.03in wire 4.50in  
 wire I55 (115, 50) pad 20 distance 36mm 1.4in +2.3= 3.74in wire 3.75in  
 wire I54 (132, 52) pad 21 distance 51mm 2.0in +2.3= 4.33in wire 4.50in  
 wire J54 (125, 36) pad 22 distance 36mm 1.4in +2.3= 3.73in wire 3.75in  
 wire I53 (148, 55) pad 23 distance 56mm 2.2in +2.3= 4.52in wire 5.00in

Longest wire I53 at 114.8mm 4.52in Mean dist 97.3mm 3.83in

11 3.75-inch wires 8 4-inch wires 4 4.5-inch wires 1 5-inch wires 0 longer wires

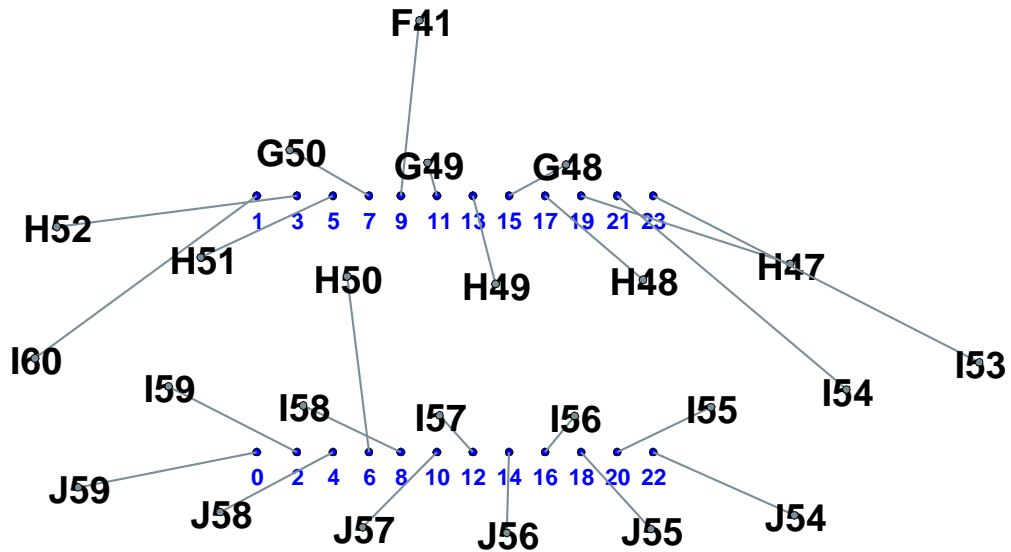



## C8

wire I69 ( 14, 60) pad 0 distance 56mm 2.2in +2.3= 4.52in wire 5.00in  
 wire H59 ( 31, 73) pad 1 distance 41mm 1.6in +2.3= 3.92in wire 4.00in  
 wire J67 ( 36, 40) pad 2 distance 40mm 1.6in +2.3= 3.91in wire 4.00in  
 wire I68 ( 30, 56) pad 3 distance 51mm 2.0in +2.3= 4.33in wire 4.50in  
 wire J66 ( 54, 37) pad 4 distance 35mm 1.4in +2.3= 3.68in wire 3.75in  
 wire G58 ( 43, 85) pad 5 distance 39mm 1.5in +2.3= 3.87in wire 4.00in  
 wire I67 ( 47, 52) pad 6 distance 40mm 1.6in +2.3= 3.89in wire 4.00in  
 wire H58 ( 49, 69) pad 7 distance 41mm 1.6in +2.3= 3.94in wire 4.00in  
 wire I66 ( 64, 50) pad 8 distance 37mm 1.5in +2.3= 3.79in wire 4.00in  
 wire G57 ( 60, 82) pad 9 distance 36mm 1.4in +2.3= 3.75in wire 4.00in  
 wire J65 ( 72, 35) pad 10 distance 34mm 1.3in +2.3= 3.67in wire 3.75in  
 wire H57 ( 67, 67) pad 11 distance 39mm 1.5in +2.3= 3.86in wire 4.00in  
 wire I65 ( 81, 49) pad 12 distance 35mm 1.4in +2.3= 3.72in wire 3.75in  
 wire H56 ( 86, 66) pad 13 distance 37mm 1.5in +2.3= 3.79in wire 4.00in  
 wire J64 ( 90, 35) pad 14 distance 33mm 1.3in +2.3= 3.63in wire 3.75in  
 wire K73 (100, 18) pad 16 distance 38mm 1.5in +2.3= 3.84in wire 4.00in  
 wire I64 ( 98, 49) pad 17 distance 47mm 1.9in +2.3= 4.18in wire 4.50in  
 wire J63 (108, 35) pad 18 distance 34mm 1.3in +2.3= 3.65in wire 3.75in  
 wire H55 (104, 66) pad 19 distance 37mm 1.5in +2.3= 3.78in wire 4.00in  
 wire I63 (115, 51) pad 20 distance 36mm 1.4in +2.3= 3.76in wire 4.00in  
 wire H54 (122, 68) pad 21 distance 39mm 1.5in +2.3= 3.85in wire 4.00in  
 wire J62 (125, 37) pad 22 distance 36mm 1.4in +2.3= 3.73in wire 3.75in  
 wire I62 (132, 53) pad 23 distance 48mm 1.9in +2.3= 4.21in wire 4.50in

Longest wire I69 at 114.9mm 4.52in Mean dist 98.6mm 3.88in

6 3.75-inch wires 13 4-inch wires 3 4.5-inch wires 1 5-inch wires 0 longer wires

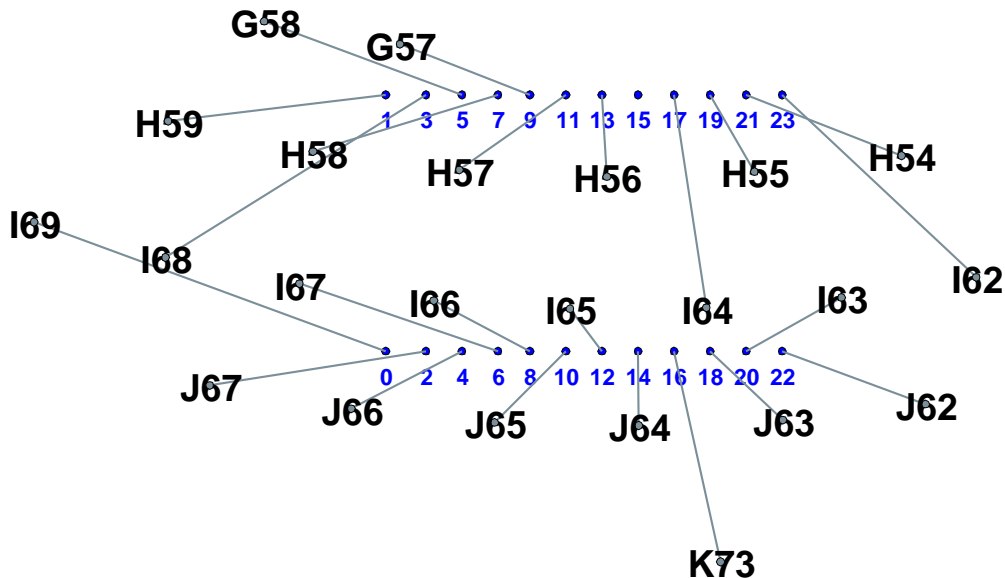

## C9

wire J77 ( 19, 43) pad 0 distance 48mm 1.9in +2.3= 4.23in wire 4.50in  
 wire H67 ( 26, 74) pad 1 distance 43mm 1.7in +2.3= 4.03in wire 4.50in  
 wire J76 ( 36, 40) pad 2 distance 40mm 1.6in +2.3= 3.90in wire 4.00in  
 wire I77 ( 31, 56) pad 3 distance 51mm 2.0in +2.3= 4.33in wire 4.50in  
 wire J75 ( 54, 37) pad 4 distance 34mm 1.4in +2.3= 3.68in wire 3.75in  
 wire I76 ( 47, 53) pad 5 distance 47mm 1.9in +2.3= 4.18in wire 4.50in  
 wire I75 ( 64, 51) pad 6 distance 33mm 1.3in +2.3= 3.64in wire 3.75in  
 wire H66 ( 44, 70) pad 7 distance 43mm 1.7in +2.3= 4.03in wire 4.50in  
 wire J74 ( 72, 36) pad 8 distance 33mm 1.3in +2.3= 3.63in wire 3.75in  
 wire H65 ( 62, 68) pad 9 distance 39mm 1.5in +2.3= 3.84in wire 4.00in  
 wire I74 ( 81, 50) pad 10 distance 35mm 1.4in +2.3= 3.72in wire 3.75in  
 wire H64 ( 81, 66) pad 11 distance 37mm 1.5in +2.3= 3.78in wire 4.00in  
 wire J73 ( 90, 36) pad 12 distance 33mm 1.3in +2.3= 3.64in wire 3.75in  
 wire I73 ( 98, 50) pad 14 distance 36mm 1.4in +2.3= 3.75in wire 4.00in  
 wire H63 ( 99, 67) pad 15 distance 38mm 1.5in +2.3= 3.81in wire 4.00in  
 wire J72 (108, 36) pad 16 distance 35mm 1.4in +2.3= 3.71in wire 3.75in  
 wire H62 (118, 69) pad 17 distance 42mm 1.6in +2.3= 3.97in wire 4.00in  
 wire I72 (115, 52) pad 18 distance 38mm 1.5in +2.3= 3.84in wire 4.00in  
 wire I71 (132, 55) pad 19 distance 53mm 2.1in +2.3= 4.42in wire 4.50in  
 wire J71 (126, 39) pad 20 distance 38mm 1.5in +2.3= 3.84in wire 4.00in  
 wire H61 (136, 72) pad 21 distance 45mm 1.8in +2.3= 4.09in wire 4.50in  
 wire J70 (144, 42) pad 22 distance 46mm 1.8in +2.3= 4.12in wire 4.50in  
 wire I70 (148, 58) pad 23 distance 54mm 2.1in +2.3= 4.47in wire 4.50in

Longest wire I70 at 113.5mm 4.47in Mean dist 100.1mm 3.94in

6 3.75-inch wires 8 4-inch wires 9 4.5-inch wires 0 5-inch wires 0 longer wires

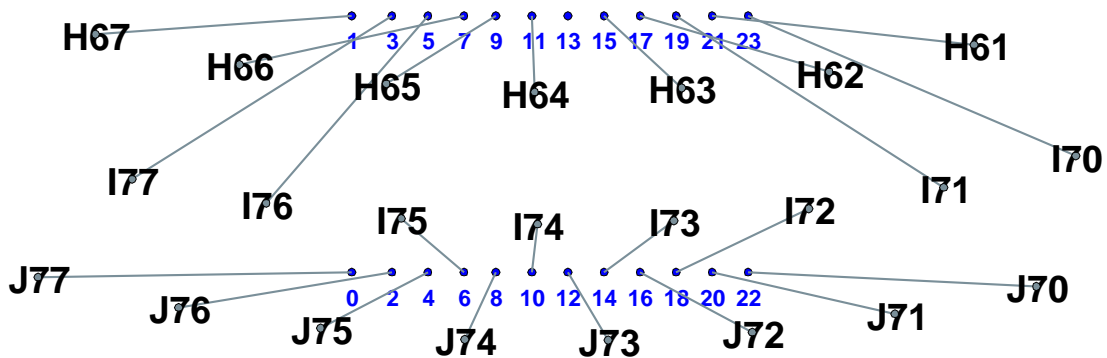

### C10

wire I85 ( 31, 56) pad 0 distance 44mm 1.7in +2.3= 4.04in wire 4.50in  
 wire I86 ( 14, 60) pad 1 distance 55mm 2.2in +2.3= 4.50in wire 4.50in  
 wire J84 ( 36, 40) pad 2 distance 40mm 1.6in +2.3= 3.90in wire 4.00in  
 wire H74 ( 24, 74) pad 3 distance 49mm 1.9in +2.3= 4.25in wire 4.50in  
 wire J83 ( 54, 37) pad 4 distance 34mm 1.4in +2.3= 3.68in wire 3.75in  
 wire H73 ( 42, 70) pad 5 distance 41mm 1.6in +2.3= 3.96in wire 4.00in  
 wire I83 ( 64, 51) pad 6 distance 33mm 1.3in +2.3= 3.64in wire 3.75in  
 wire I84 ( 47, 53) pad 7 distance 50mm 2.0in +2.3= 4.29in wire 4.50in  
 wire J82 ( 72, 36) pad 8 distance 33mm 1.3in +2.3= 3.63in wire 3.75in  
 wire H72 ( 60, 68) pad 9 distance 39mm 1.5in +2.3= 3.87in wire 4.00in  
 wire I82 ( 81, 50) pad 10 distance 35mm 1.4in +2.3= 3.72in wire 3.75in  
 wire H71 ( 78, 67) pad 11 distance 37mm 1.5in +2.3= 3.77in wire 4.00in  
 wire J81 ( 90, 36) pad 12 distance 33mm 1.3in +2.3= 3.64in wire 3.75in  
 wire I81 ( 98, 50) pad 14 distance 36mm 1.4in +2.3= 3.75in wire 4.00in  
 wire H70 ( 97, 67) pad 15 distance 37mm 1.5in +2.3= 3.79in wire 4.00in  
 wire J80 (108, 37) pad 16 distance 35mm 1.4in +2.3= 3.71in wire 3.75in  
 wire H69 (115, 69) pad 17 distance 41mm 1.6in +2.3= 3.93in wire 4.00in  
 wire I80 (115, 52) pad 18 distance 39mm 1.5in +2.3= 3.84in wire 4.00in  
 wire G68 (122, 85) pad 19 distance 39mm 1.5in +2.3= 3.86in wire 4.00in  
 wire I79 (132, 55) pad 20 distance 45mm 1.8in +2.3= 4.10in wire 4.50in  
 wire H68 (134, 72) pad 21 distance 43mm 1.7in +2.3= 4.03in wire 4.50in  
 wire I78 (148, 59) pad 22 distance 53mm 2.1in +2.3= 4.41in wire 4.50in  
 wire G67 (139, 89) pad 23 distance 43mm 1.7in +2.3= 4.01in wire 4.50in

Longest wire I86 at 114.3mm 4.50in Mean dist 99.7mm 3.93in

6 3.75-inch wires 9 4-inch wires 8 4.5-inch wires 0 5-inch wires 0 longer wires

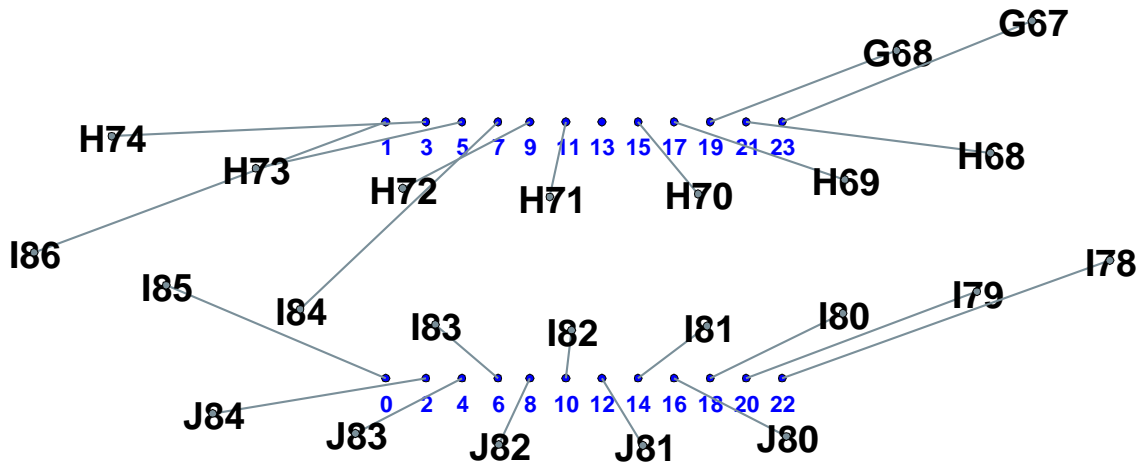

## C11

wire I93 ( 31, 55) pad 0 distance 44mm 1.7in +2.3= 4.04in wire 4.50in  
 wire I1 ( 14, 59) pad 1 distance 55mm 2.2in +2.3= 4.50in wire 5.00in  
 wire J92 ( 36, 39) pad 2 distance 40mm 1.6in +2.3= 3.90in wire 4.00in  
 wire H80 ( 40, 70) pad 3 distance 40mm 1.6in +2.3= 3.89in wire 4.00in  
 wire J91 ( 54, 37) pad 4 distance 34mm 1.4in +2.3= 3.68in wire 3.75in  
 wire I92 ( 47, 52) pad 5 distance 47mm 1.9in +2.3= 4.19in wire 4.50in  
 wire I91 ( 64, 51) pad 6 distance 33mm 1.3in +2.3= 3.64in wire 3.75in  
 wire H79 ( 58, 68) pad 7 distance 38mm 1.5in +2.3= 3.82in wire 4.00in  
 wire J90 ( 72, 36) pad 8 distance 33mm 1.3in +2.3= 3.63in wire 3.75in  
 wire H78 ( 76, 67) pad 9 distance 37mm 1.4in +2.3= 3.77in wire 4.00in  
 wire I90 ( 81, 50) pad 10 distance 35mm 1.4in +2.3= 3.72in wire 3.75in  
 wire J89 ( 90, 36) pad 12 distance 33mm 1.3in +2.3= 3.64in wire 3.75in  
 wire G77 ( 85, 82) pad 13 distance 33mm 1.3in +2.3= 3.62in wire 3.75in  
 wire H77 ( 95, 67) pad 14 distance 45mm 1.8in +2.3= 4.08in wire 4.50in  
 wire G76 (103, 82) pad 15 distance 35mm 1.4in +2.3= 3.71in wire 3.75in  
 wire I89 ( 98, 51) pad 16 distance 36mm 1.4in +2.3= 3.73in wire 3.75in  
 wire F63 (104,100) pad 17 distance 38mm 1.5in +2.3= 3.83in wire 4.00in  
 wire J88 (108, 37) pad 18 distance 34mm 1.3in +2.3= 3.65in wire 3.75in  
 wire H76 (113, 69) pad 19 distance 38mm 1.5in +2.3= 3.82in wire 4.00in  
 wire I88 (115, 52) pad 20 distance 37mm 1.5in +2.3= 3.78in wire 4.00in  
 wire G75 (120, 85) pad 21 distance 35mm 1.4in +2.3= 3.72in wire 3.75in  
 wire I87 (132, 55) pad 22 distance 42mm 1.6in +2.3= 3.97in wire 4.00in  
 wire H75 (131, 72) pad 23 distance 40mm 1.6in +2.3= 3.88in wire 4.00in

Longest wire I1 at 114.4mm 4.50in Mean dist 97.4mm 3.84in

10 3.75-inch wires 9 4-inch wires 3 4.5-inch wires 1 5-inch wires 0 longer wires

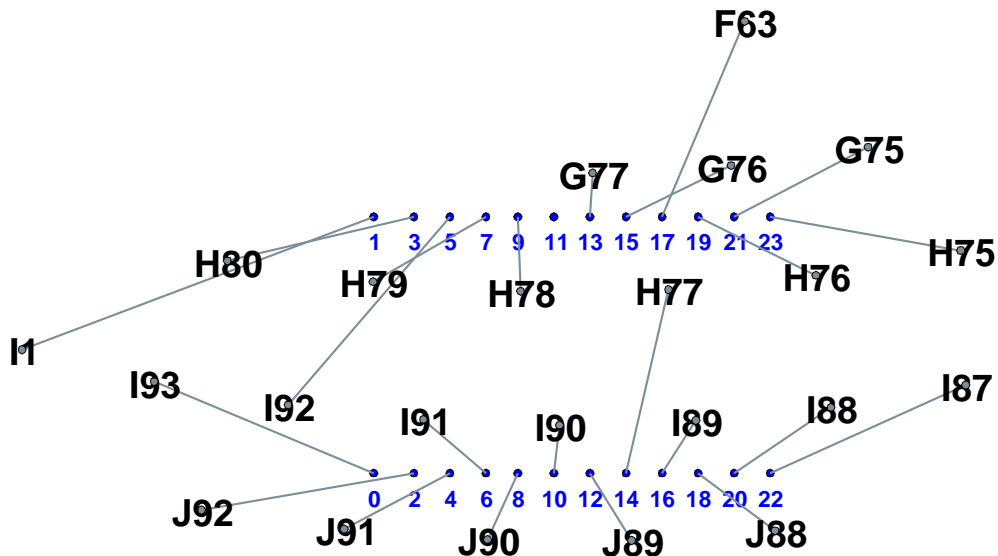

# D1

wire M4 ( 32, 41) pad 0 distance 40mm 1.6in +2.3= 3.89in wire 4.00in  
 wire K5 ( 25, 73) pad 1 distance 44mm 1.7in +2.3= 4.04in wire 4.50in  
 wire M3 ( 48, 38) pad 2 distance 35mm 1.4in +2.3= 3.69in wire 3.75in  
 wire L4 ( 31, 57) pad 3 distance 50mm 2.0in +2.3= 4.29in wire 4.50in  
 wire L3 ( 48, 54) pad 4 distance 40mm 1.6in +2.3= 3.90in wire 4.00in  
 wire K4 ( 42, 70) pad 5 distance 42mm 1.6in +2.3= 3.96in wire 4.00in  
 wire L2 ( 66, 52) pad 6 distance 33mm 1.3in +2.3= 3.64in wire 3.75in  
 wire K3 ( 58, 67) pad 7 distance 38mm 1.5in +2.3= 3.82in wire 4.00in  
 wire M2 ( 64, 36) pad 8 distance 35mm 1.4in +2.3= 3.70in wire 3.75in  
 wire K2 ( 75, 66) pad 9 distance 37mm 1.5in +2.3= 3.79in wire 4.00in  
 wire M1 ( 80, 35) pad 10 distance 33mm 1.3in +2.3= 3.62in wire 3.75in  
 wire J1 ( 79, 83) pad 11 distance 33mm 1.3in +2.3= 3.62in wire 3.75in  
 wire L1 ( 83, 51) pad 12 distance 36mm 1.4in +2.3= 3.74in wire 3.75in  
 wire K1 ( 92, 65) pad 13 distance 38mm 1.5in +2.3= 3.82in wire 4.00in  
 wire M123 ( 96, 35) pad 14 distance 33mm 1.3in +2.3= 3.64in wire 3.75in  
 wire J93 ( 97, 83) pad 15 distance 34mm 1.3in +2.3= 3.65in wire 3.75in  
 wire L106 (101, 51) pad 16 distance 36mm 1.4in +2.3= 3.75in wire 3.75in  
 wire K106 (109, 66) pad 17 distance 39mm 1.5in +2.3= 3.87in wire 4.00in  
 wire M122 (112, 36) pad 18 distance 35mm 1.4in +2.3= 3.69in wire 3.75in  
 wire K105 (125, 68) pad 19 distance 44mm 1.7in +2.3= 4.05in wire 4.50in  
 wire L105 (118, 52) pad 20 distance 38mm 1.5in +2.3= 3.82in wire 4.00in  
 wire L104 (136, 54) pad 21 distance 52mm 2.0in +2.3= 4.36in wire 4.50in  
 wire M121 (128, 37) pad 22 distance 37mm 1.4in +2.3= 3.77in wire 4.00in  
 wire K104 (142, 70) pad 23 distance 46mm 1.8in +2.3= 4.14in wire 4.50in

Longest wire L104 at 110.8mm 4.36in Mean dist 97.6mm 3.84in

10 3.75-inch wires 9 4-inch wires 5 4.5-inch wires 0 5-inch wires 0 longer wires

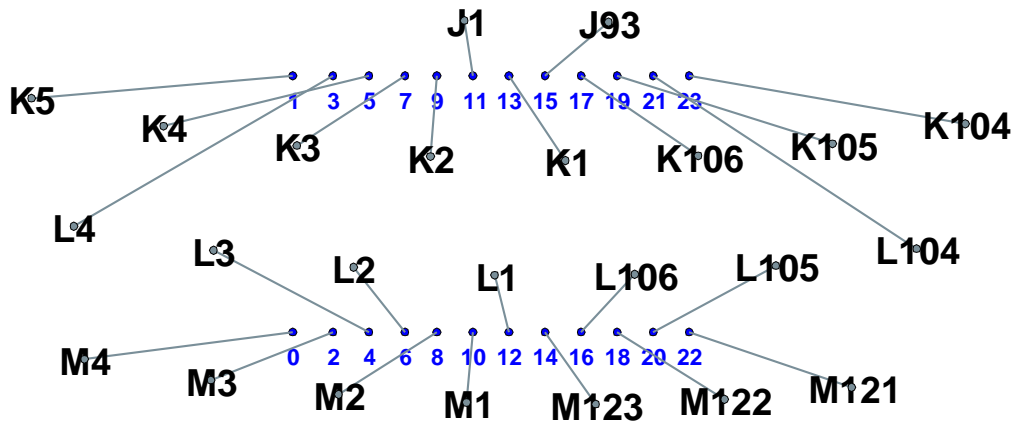

## D2

wire L11 ( 31, 57) pad 0 distance 44mm 1.7in +2.3= 4.07in wire 4.50in  
 wire K12 ( 25, 73) pad 1 distance 44mm 1.7in +2.3= 4.05in wire 4.50in  
 wire M12 ( 34, 40) pad 2 distance 42mm 1.6in +2.3= 3.96in wire 4.00in  
 wire K11 ( 42, 70) pad 3 distance 39mm 1.5in +2.3= 3.87in wire 4.00in  
 wire M11 ( 50, 38) pad 4 distance 36mm 1.4in +2.3= 3.74in wire 3.75in  
 wire L10 ( 48, 54) pad 5 distance 46mm 1.8in +2.3= 4.14in wire 4.50in  
 wire L9 ( 66, 52) pad 6 distance 33mm 1.3in +2.3= 3.64in wire 3.75in  
 wire J9 ( 46, 86) pad 7 distance 40mm 1.6in +2.3= 3.91in wire 4.00in  
 wire M10 ( 66, 36) pad 8 distance 34mm 1.4in +2.3= 3.67in wire 3.75in  
 wire K10 ( 58, 67) pad 9 distance 40mm 1.6in +2.3= 3.90in wire 4.00in  
 wire M9 ( 82, 35) pad 10 distance 33mm 1.3in +2.3= 3.63in wire 3.75in  
 wire K9 ( 75, 66) pad 11 distance 38mm 1.5in +2.3= 3.80in wire 4.00in  
 wire L8 ( 83, 51) pad 12 distance 36mm 1.4in +2.3= 3.74in wire 3.75in  
 wire M8 ( 98, 35) pad 14 distance 34mm 1.3in +2.3= 3.65in wire 3.75in  
 wire K8 ( 92, 65) pad 15 distance 37mm 1.5in +2.3= 3.80in wire 4.00in  
 wire N8 (106, 22) pad 16 distance 38mm 1.5in +2.3= 3.82in wire 4.00in  
 wire L7 (101, 51) pad 17 distance 46mm 1.8in +2.3= 4.14in wire 4.50in  
 wire M7 (114, 36) pad 18 distance 35mm 1.4in +2.3= 3.72in wire 3.75in  
 wire K7 (109, 66) pad 19 distance 38mm 1.5in +2.3= 3.82in wire 4.00in  
 wire L6 (118, 52) pad 20 distance 38mm 1.5in +2.3= 3.82in wire 4.00in  
 wire K6 (126, 68) pad 21 distance 41mm 1.6in +2.3= 3.92in wire 4.00in  
 wire M6 (130, 37) pad 22 distance 37mm 1.5in +2.3= 3.80in wire 4.00in  
 wire L5 (136, 54) pad 23 distance 49mm 1.9in +2.3= 4.26in wire 4.50in

Longest wire L5 at 108.3mm 4.26in Mean dist 98.1mm 3.86in

7 3.75-inch wires 11 4-inch wires 5 4.5-inch wires 0 5-inch wires 0 longer wires

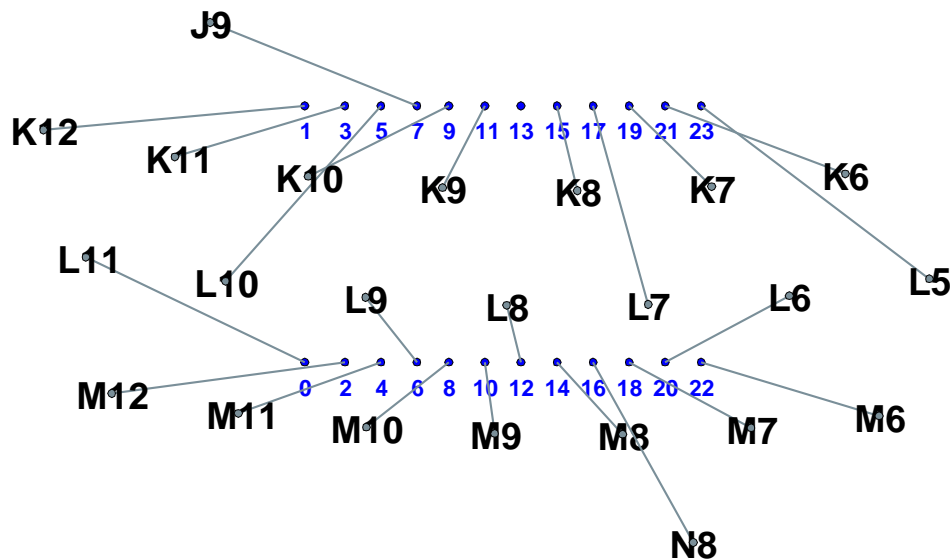

### D3

wire M22 ( 23, 42) pad 0 distance 46mm 1.8in +2.3= 4.12in wire 4.50in  
 wire K20 ( 25, 73) pad 1 distance 44mm 1.7in +2.3= 4.04in wire 4.50in  
 wire M21 ( 38, 39) pad 2 distance 39mm 1.5in +2.3= 3.86in wire 4.00in  
 wire L19 ( 31, 57) pad 3 distance 50mm 2.0in +2.3= 4.29in wire 4.50in  
 wire M20 ( 54, 37) pad 4 distance 34mm 1.4in +2.3= 3.68in wire 3.75in  
 wire K19 ( 42, 70) pad 5 distance 42mm 1.6in +2.3= 3.96in wire 4.00in  
 wire L17 ( 66, 52) pad 6 distance 33mm 1.3in +2.3= 3.64in wire 3.75in  
 wire L18 ( 48, 54) pad 7 distance 49mm 1.9in +2.3= 4.23in wire 4.50in  
 wire M19 ( 70, 36) pad 8 distance 33mm 1.3in +2.3= 3.64in wire 3.75in  
 wire K18 ( 58, 67) pad 9 distance 40mm 1.6in +2.3= 3.90in wire 4.00in  
 wire L16 ( 83, 51) pad 10 distance 36mm 1.4in +2.3= 3.74in wire 3.75in  
 wire K17 ( 75, 66) pad 11 distance 38mm 1.5in +2.3= 3.80in wire 4.00in  
 wire M18 ( 86, 35) pad 12 distance 33mm 1.3in +2.3= 3.63in wire 3.75in  
 wire L15 (101, 51) pad 14 distance 37mm 1.5in +2.3= 3.79in wire 4.00in  
 wire K16 ( 92, 65) pad 15 distance 37mm 1.5in +2.3= 3.80in wire 4.00in  
 wire M17 (102, 35) pad 16 distance 34mm 1.3in +2.3= 3.65in wire 3.75in  
 wire K15 (109, 66) pad 17 distance 39mm 1.5in +2.3= 3.87in wire 4.00in  
 wire M16 (118, 36) pad 18 distance 37mm 1.5in +2.3= 3.79in wire 4.00in  
 wire K14 (126, 68) pad 19 distance 44mm 1.7in +2.3= 4.05in wire 4.50in  
 wire L14 (118, 52) pad 20 distance 38mm 1.5in +2.3= 3.82in wire 4.00in  
 wire L13 (136, 54) pad 21 distance 52mm 2.0in +2.3= 4.37in wire 4.50in  
 wire M15 (134, 38) pad 22 distance 40mm 1.6in +2.3= 3.89in wire 4.00in  
 wire K13 (142, 70) pad 23 distance 46mm 1.8in +2.3= 4.14in wire 4.50in

Longest wire L13 at 110.9mm 4.37in Mean dist 99.1mm 3.90in

6 3.75-inch wires 10 4-inch wires 7 4.5-inch wires 0 5-inch wires 0 longer wires

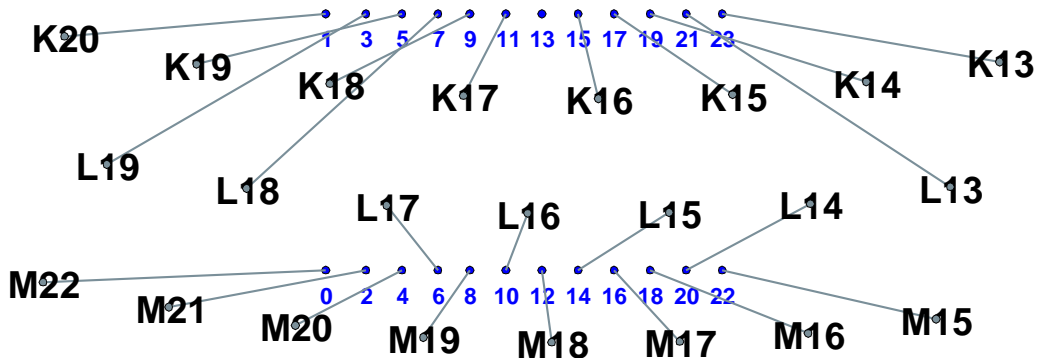

## D4

wire M30 ( 25, 42) pad 0 distance 44mm 1.7in +2.3= 4.07in wire 4.50in  
 wire K27 ( 25, 73) pad 1 distance 44mm 1.7in +2.3= 4.04in wire 4.50in  
 wire M29 ( 40, 39) pad 2 distance 38mm 1.5in +2.3= 3.82in wire 4.00in  
 wire L26 ( 31, 57) pad 3 distance 50mm 2.0in +2.3= 4.29in wire 4.50in  
 wire M28 ( 56, 37) pad 4 distance 34mm 1.3in +2.3= 3.66in wire 3.75in  
 wire K26 ( 42, 70) pad 5 distance 42mm 1.6in +2.3= 3.96in wire 4.00in  
 wire L24 ( 66, 52) pad 6 distance 33mm 1.3in +2.3= 3.64in wire 3.75in  
 wire L25 ( 48, 54) pad 7 distance 49mm 1.9in +2.3= 4.24in wire 4.50in  
 wire M27 ( 72, 36) pad 8 distance 33mm 1.3in +2.3= 3.63in wire 3.75in  
 wire K25 ( 58, 67) pad 9 distance 40mm 1.6in +2.3= 3.90in wire 4.00in  
 wire L23 ( 83, 51) pad 10 distance 36mm 1.4in +2.3= 3.74in wire 3.75in  
 wire K24 ( 75, 66) pad 11 distance 37mm 1.5in +2.3= 3.80in wire 4.00in  
 wire M26 ( 88, 35) pad 12 distance 33mm 1.3in +2.3= 3.63in wire 3.75in  
 wire K23 ( 92, 65) pad 13 distance 38mm 1.5in +2.3= 3.82in wire 4.00in  
 wire L22 (101, 51) pad 14 distance 37mm 1.5in +2.3= 3.79in wire 4.00in  
 wire J19 (103, 83) pad 15 distance 35mm 1.4in +2.3= 3.72in wire 3.75in  
 wire M25 (104, 35) pad 16 distance 34mm 1.3in +2.3= 3.66in wire 3.75in  
 wire K22 (109, 66) pad 17 distance 39mm 1.5in +2.3= 3.87in wire 4.00in  
 wire L21 (118, 52) pad 18 distance 40mm 1.6in +2.3= 3.90in wire 4.00in  
 wire I19 (111, 98) pad 19 distance 37mm 1.5in +2.3= 3.80in wire 4.00in  
 wire M24 (120, 36) pad 20 distance 36mm 1.4in +2.3= 3.74in wire 3.75in  
 wire J18 (121, 84) pad 21 distance 36mm 1.4in +2.3= 3.73in wire 3.75in  
 wire L20 (136, 54) pad 22 distance 44mm 1.7in +2.3= 4.04in wire 4.50in  
 wire K21 (126, 68) pad 23 distance 38mm 1.5in +2.3= 3.84in wire 4.00in

Longest wire L26 at 109.0mm 4.29in Mean dist 97.7mm 3.85in

9 3.75-inch wires 10 4-inch wires 5 4.5-inch wires 0 5-inch wires 0 longer wires

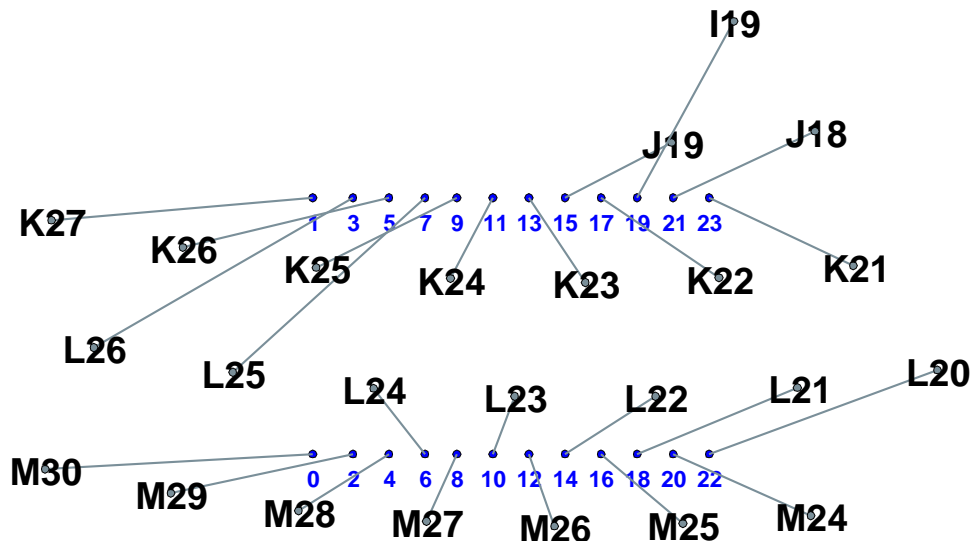



## D5

wire M38 ( 45, 38) pad 0 distance 34mm 1.3in +2.3= 3.67in wire 3.75in  
 wire K35 ( 25, 73) pad 1 distance 44mm 1.7in +2.3= 4.04in wire 4.50in  
 wire L33 ( 48, 54) pad 2 distance 38mm 1.5in +2.3= 3.83in wire 4.00in  
 wire L34 ( 31, 57) pad 3 distance 50mm 2.0in +2.3= 4.29in wire 4.50in  
 wire M37 ( 61, 36) pad 4 distance 33mm 1.3in +2.3= 3.63in wire 3.75in  
 wire K34 ( 42, 70) pad 5 distance 42mm 1.6in +2.3= 3.96in wire 4.00in  
 wire L32 ( 66, 52) pad 6 distance 33mm 1.3in +2.3= 3.64in wire 3.75in  
 wire K33 ( 58, 67) pad 7 distance 38mm 1.5in +2.3= 3.82in wire 4.00in  
 wire N37 ( 68, 22) pad 8 distance 37mm 1.5in +2.3= 3.78in wire 4.00in  
 wire J28 ( 67, 84) pad 9 distance 34mm 1.3in +2.3= 3.66in wire 3.75in  
 wire M36 ( 77, 35) pad 10 distance 33mm 1.3in +2.3= 3.63in wire 3.75in  
 wire K32 ( 75, 66) pad 11 distance 38mm 1.5in +2.3= 3.80in wire 4.00in  
 wire L31 ( 83, 51) pad 12 distance 36mm 1.4in +2.3= 3.74in wire 3.75in  
 wire J27 ( 85, 83) pad 13 distance 33mm 1.3in +2.3= 3.62in wire 3.75in  
 wire M35 ( 93, 35) pad 14 distance 33mm 1.3in +2.3= 3.63in wire 3.75in  
 wire K31 ( 92, 65) pad 15 distance 38mm 1.5in +2.3= 3.80in wire 4.00in  
 wire L30 (101, 51) pad 16 distance 36mm 1.4in +2.3= 3.75in wire 3.75in  
 wire J26 (103, 83) pad 17 distance 34mm 1.3in +2.3= 3.65in wire 3.75in  
 wire M34 (109, 35) pad 18 distance 34mm 1.3in +2.3= 3.66in wire 3.75in  
 wire K30 (109, 66) pad 19 distance 38mm 1.5in +2.3= 3.82in wire 4.00in  
 wire L29 (118, 52) pad 20 distance 38mm 1.5in +2.3= 3.82in wire 4.00in  
 wire K29 (126, 67) pad 21 distance 41mm 1.6in +2.3= 3.92in wire 4.00in  
 wire L28 (136, 54) pad 22 distance 44mm 1.7in +2.3= 4.04in wire 4.50in  
 wire K28 (142, 70) pad 23 distance 46mm 1.8in +2.3= 4.14in wire 4.50in

Longest wire L34 at 109.0mm 4.29in Mean dist 96.7mm 3.81in

11 3.75-inch wires 9 4-inch wires 4 4.5-inch wires 0 5-inch wires 0 longer wires

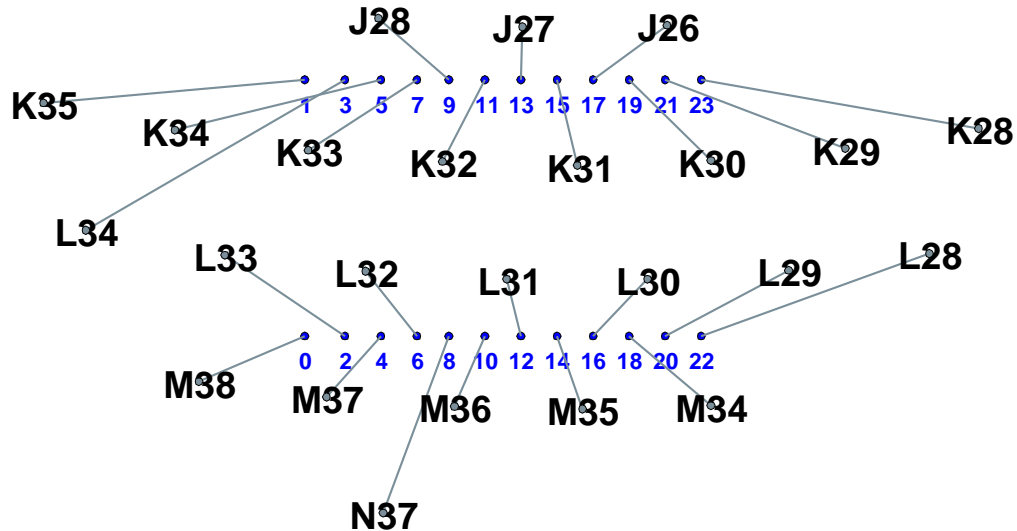

## D6

wire L41 ( 31, 57) pad 0 distance 44mm 1.7in +2.3= 4.07in wire 4.50in  
 wire K42 ( 25, 73) pad 1 distance 44mm 1.7in +2.3= 4.04in wire 4.50in  
 wire M47 ( 31, 41) pad 2 distance 43mm 1.7in +2.3= 4.03in wire 4.50in  
 wire K41 ( 42, 70) pad 3 distance 39mm 1.5in +2.3= 3.87in wire 4.00in  
 wire M46 ( 47, 38) pad 4 distance 37mm 1.5in +2.3= 3.79in wire 4.00in  
 wire J35 ( 52, 86) pad 5 distance 35mm 1.4in +2.3= 3.71in wire 3.75in  
 wire L40 ( 48, 54) pad 6 distance 40mm 1.6in +2.3= 3.88in wire 4.00in  
 wire K40 ( 58, 67) pad 7 distance 38mm 1.5in +2.3= 3.82in wire 4.00in  
 wire M45 ( 63, 36) pad 8 distance 35mm 1.4in +2.3= 3.71in wire 3.75in  
 wire I35 ( 62, 99) pad 9 distance 39mm 1.5in +2.3= 3.84in wire 4.00in  
 wire L39 ( 66, 52) pad 10 distance 39mm 1.5in +2.3= 3.86in wire 4.00in  
 wire J34 ( 70, 83) pad 11 distance 35mm 1.4in +2.3= 3.68in wire 3.75in  
 wire M44 ( 79, 35) pad 12 distance 34mm 1.3in +2.3= 3.65in wire 3.75in  
 wire K39 ( 75, 66) pad 13 distance 39mm 1.5in +2.3= 3.84in wire 4.00in  
 wire L38 ( 83, 51) pad 14 distance 37mm 1.4in +2.3= 3.77in wire 4.00in  
 wire K38 ( 92, 65) pad 15 distance 38mm 1.5in +2.3= 3.80in wire 4.00in  
 wire M43 ( 95, 35) pad 16 distance 33mm 1.3in +2.3= 3.63in wire 3.75in  
 wire L37 (101, 51) pad 18 distance 35mm 1.4in +2.3= 3.72in wire 3.75in  
 wire K37 (109, 66) pad 19 distance 38mm 1.5in +2.3= 3.82in wire 4.00in  
 wire M42 (111, 35) pad 20 distance 33mm 1.3in +2.3= 3.64in wire 3.75in  
 wire K36 (125, 67) pad 21 distance 41mm 1.6in +2.3= 3.92in wire 4.00in  
 wire L36 (118, 52) pad 22 distance 36mm 1.4in +2.3= 3.74in wire 3.75in  
 wire L35 (136, 54) pad 23 distance 49mm 1.9in +2.3= 4.26in wire 4.50in

Longest wire L35 at 108.3mm 4.26in Mean dist 97.3mm 3.83in

8 3.75-inch wires 11 4-inch wires 4 4.5-inch wires 0 5-inch wires 0 longer wires

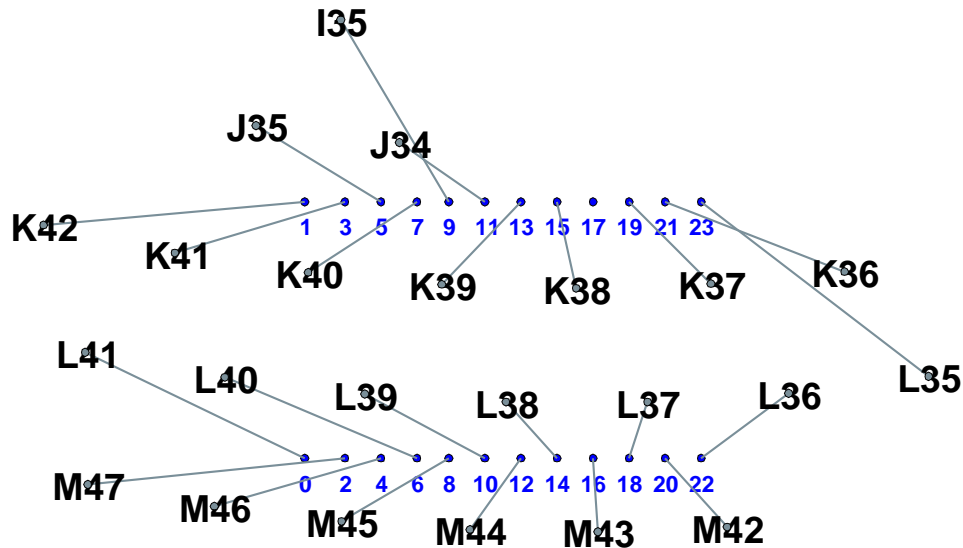

# D7

wire L49 ( 31, 57) pad 0 distance 44mm 1.7in +2.3= 4.07in wire 4.50in  
wire K50 ( 25, 73) pad 1 distance 44mm 1.7in +2.3= 4.05in wire 4.50in  
wire L48 ( 48, 54) pad 2 distance 38mm 1.5in +2.3= 3.83in wire 4.00in  
wire J43 ( 34, 89) pad 3 distance 42mm 1.6in +2.3= 3.96in wire 4.00in  
wire M54 ( 67, 36) pad 4 distance 33mm 1.3in +2.3= 3.63in wire 3.75in  
wire K49 ( 42, 70) pad 5 distance 42mm 1.6in +2.3= 3.96in wire 4.00in  
wire L47 ( 66, 52) pad 6 distance 33mm 1.3in +2.3= 3.64in wire 3.75in  
wire J42 ( 52, 85) pad 7 distance 37mm 1.5in +2.3= 3.78in wire 4.00in  
wire L46 ( 83, 51) pad 8 distance 37mm 1.4in +2.3= 3.77in wire 4.00in  
wire K48 ( 58, 67) pad 9 distance 40mm 1.6in +2.3= 3.90in wire 4.00in  
wire M53 ( 83, 35) pad 10 distance 33mm 1.3in +2.3= 3.63in wire 3.75in  
wire K47 ( 75, 66) pad 11 distance 38mm 1.5in +2.3= 3.80in wire 4.00in  
wire N53 ( 91, 21) pad 12 distance 37mm 1.5in +2.3= 3.79in wire 4.00in  
wire K46 ( 92, 65) pad 13 distance 38mm 1.5in +2.3= 3.82in wire 4.00in  
wire M52 ( 99, 35) pad 14 distance 34mm 1.3in +2.3= 3.66in wire 3.75in  
wire L45 (101, 51) pad 15 distance 47mm 1.9in +2.3= 4.18in wire 4.50in  
wire N52 (108, 22) pad 16 distance 38mm 1.5in +2.3= 3.83in wire 4.00in  
wire K45 (109, 66) pad 17 distance 39mm 1.5in +2.3= 3.87in wire 4.00in  
wire M51 (115, 36) pad 18 distance 36mm 1.4in +2.3= 3.74in wire 3.75in  
wire K44 (125, 67) pad 19 distance 44mm 1.7in +2.3= 4.05in wire 4.50in  
wire L44 (118, 52) pad 20 distance 38mm 1.5in +2.3= 3.82in wire 4.00in  
wire L43 (136, 54) pad 21 distance 52mm 2.0in +2.3= 4.36in wire 4.50in  
wire M50 (131, 38) pad 22 distance 38mm 1.5in +2.3= 3.83in wire 4.00in  
wire K43 (142, 70) pad 23 distance 46mm 1.8in +2.3= 4.14in wire 4.50in

Longest wire L43 at 110.8mm 4.36in Mean dist 98.6mm 3.88in

5 3.75-inch wires 13 4-inch wires 6 4.5-inch wires 0 5-inch wires 0 longer wires

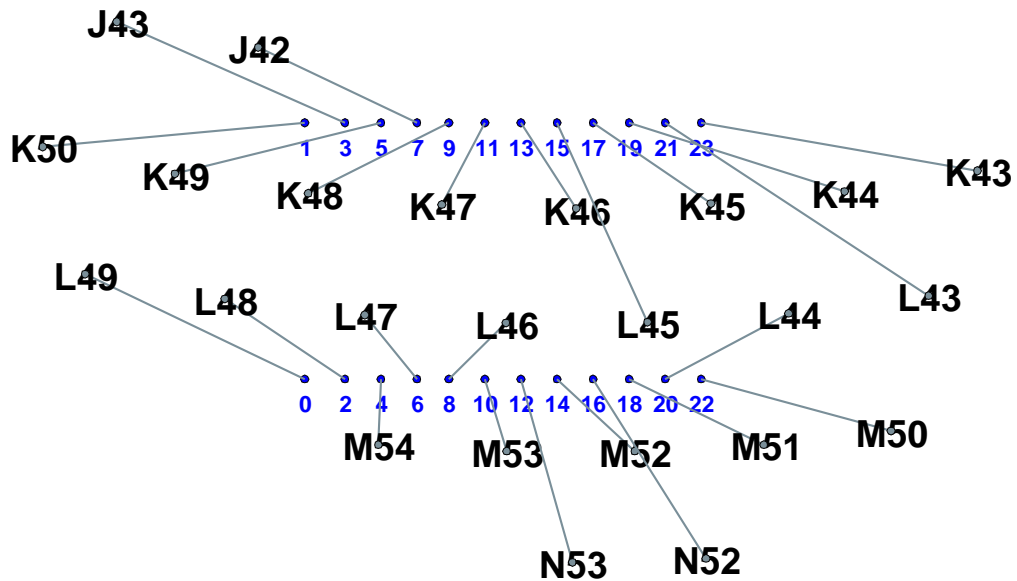

## D8

wire M65 ( 22, 43) pad 0 distance 46mm 1.8in +2.3= 4.14in wire 4.50in  
 wire L57 ( 14, 61) pad 1 distance 55mm 2.2in +2.3= 4.49in wire 4.50in  
 wire M64 ( 38, 40) pad 2 distance 39mm 1.6in +2.3= 3.87in wire 4.00in  
 wire K57 ( 25, 73) pad 3 distance 48mm 1.9in +2.3= 4.21in wire 4.50in  
 wire M63 ( 53, 37) pad 4 distance 35mm 1.4in +2.3= 3.69in wire 3.75in  
 wire L56 ( 31, 57) pad 5 distance 53mm 2.1in +2.3= 4.41in wire 4.50in  
 wire L55 ( 48, 54) pad 6 distance 40mm 1.6in +2.3= 3.88in wire 4.00in  
 wire K56 ( 42, 70) pad 7 distance 45mm 1.8in +2.3= 4.09in wire 4.50in  
 wire L54 ( 66, 52) pad 8 distance 37mm 1.5in +2.3= 3.80in wire 4.00in  
 wire K55 ( 58, 67) pad 9 distance 40mm 1.6in +2.3= 3.90in wire 4.00in  
 wire M62 ( 69, 36) pad 10 distance 35mm 1.4in +2.3= 3.69in wire 3.75in  
 wire K54 ( 75, 66) pad 11 distance 37mm 1.5in +2.3= 3.80in wire 4.00in  
 wire M61 ( 85, 35) pad 12 distance 33mm 1.3in +2.3= 3.62in wire 3.75in  
 wire L53 ( 83, 51) pad 13 distance 46mm 1.8in +2.3= 4.13in wire 4.50in  
 wire L52 (101, 51) pad 14 distance 37mm 1.5in +2.3= 3.79in wire 4.00in  
 wire K53 ( 92, 66) pad 15 distance 37mm 1.5in +2.3= 3.80in wire 4.00in  
 wire M60 (101, 35) pad 16 distance 33mm 1.3in +2.3= 3.64in wire 3.75in  
 wire K52 (109, 66) pad 17 distance 39mm 1.5in +2.3= 3.87in wire 4.00in  
 wire M59 (117, 36) pad 18 distance 37mm 1.5in +2.3= 3.78in wire 4.00in  
 wire J44 (126, 85) pad 19 distance 42mm 1.6in +2.3= 3.96in wire 4.00in  
 wire L51 (118, 52) pad 20 distance 38mm 1.5in +2.3= 3.82in wire 4.00in  
 wire K51 (126, 68) pad 21 distance 40mm 1.6in +2.3= 3.92in wire 4.00in  
 wire M58 (133, 38) pad 22 distance 39mm 1.5in +2.3= 3.87in wire 4.00in  
 wire L50 (136, 55) pad 23 distance 49mm 1.9in +2.3= 4.26in wire 4.50in

Longest wire L57 at 114.1mm 4.49in Mean dist 99.9mm 3.93in

4 3.75-inch wires 13 4-inch wires 7 4.5-inch wires 0 5-inch wires 0 longer wires

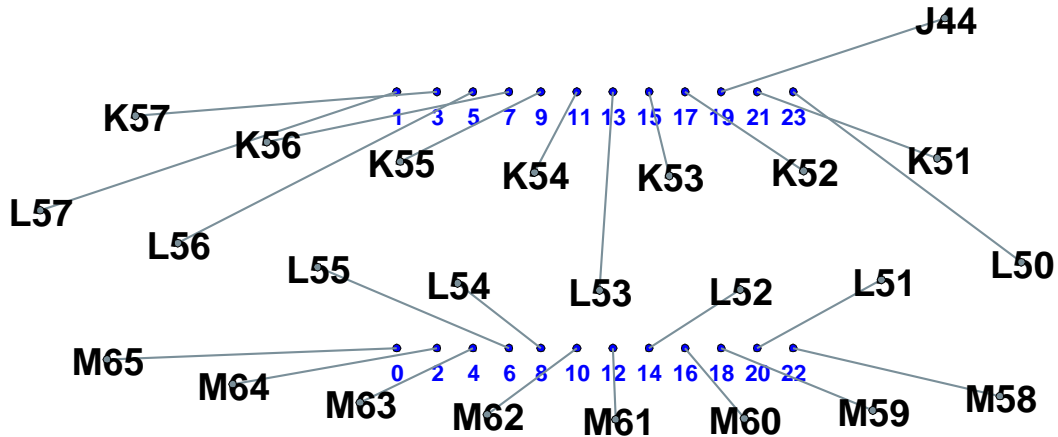

## D9

wire M73 ( 42, 39) pad 0 distance 35mm 1.4in +2.3= 3.71in wire 3.75in  
 wire K65 ( 25, 73) pad 1 distance 44mm 1.7in +2.3= 4.05in wire 4.50in  
 wire L63 ( 48, 54) pad 2 distance 38mm 1.5in +2.3= 3.83in wire 4.00in  
 wire L64 ( 31, 57) pad 3 distance 50mm 2.0in +2.3= 4.30in wire 4.50in  
 wire M72 ( 58, 37) pad 4 distance 34mm 1.3in +2.3= 3.65in wire 3.75in  
 wire K64 ( 42, 70) pad 5 distance 42mm 1.6in +2.3= 3.96in wire 4.00in  
 wire L62 ( 66, 52) pad 6 distance 33mm 1.3in +2.3= 3.64in wire 3.75in  
 wire K63 ( 58, 67) pad 7 distance 38mm 1.5in +2.3= 3.82in wire 4.00in  
 wire M71 ( 74, 36) pad 8 distance 33mm 1.3in +2.3= 3.62in wire 3.75in  
 wire K62 ( 75, 66) pad 9 distance 37mm 1.5in +2.3= 3.79in wire 4.00in  
 wire L61 ( 83, 51) pad 10 distance 36mm 1.4in +2.3= 3.74in wire 3.75in  
 wire J53 ( 91, 83) pad 11 distance 35mm 1.4in +2.3= 3.69in wire 3.75in  
 wire M70 ( 90, 35) pad 12 distance 33mm 1.3in +2.3= 3.64in wire 3.75in  
 wire K61 ( 92, 66) pad 13 distance 38mm 1.5in +2.3= 3.82in wire 4.00in  
 wire L60 (101, 51) pad 14 distance 37mm 1.5in +2.3= 3.79in wire 4.00in  
 wire J52 (109, 83) pad 15 distance 38mm 1.5in +2.3= 3.82in wire 4.00in  
 wire M69 (106, 35) pad 16 distance 34mm 1.4in +2.3= 3.68in wire 3.75in  
 wire I52 (116, 99) pad 17 distance 42mm 1.6in +2.3= 3.97in wire 4.00in  
 wire K60 (109, 66) pad 18 distance 44mm 1.7in +2.3= 4.06in wire 4.50in  
 wire J51 (127, 85) pad 19 distance 42mm 1.6in +2.3= 3.97in wire 4.00in  
 wire L59 (118, 52) pad 20 distance 38mm 1.5in +2.3= 3.82in wire 4.00in  
 wire K59 (125, 68) pad 21 distance 40mm 1.6in +2.3= 3.91in wire 4.00in  
 wire L58 (136, 55) pad 22 distance 44mm 1.7in +2.3= 4.04in wire 4.50in  
 wire K58 (142, 70) pad 23 distance 46mm 1.8in +2.3= 4.14in wire 4.50in

Longest wire L64 at 109.1mm 4.30in Mean dist 97.8mm 3.85in

8 3.75-inch wires 11 4-inch wires 5 4.5-inch wires 0 5-inch wires 0 longer wires

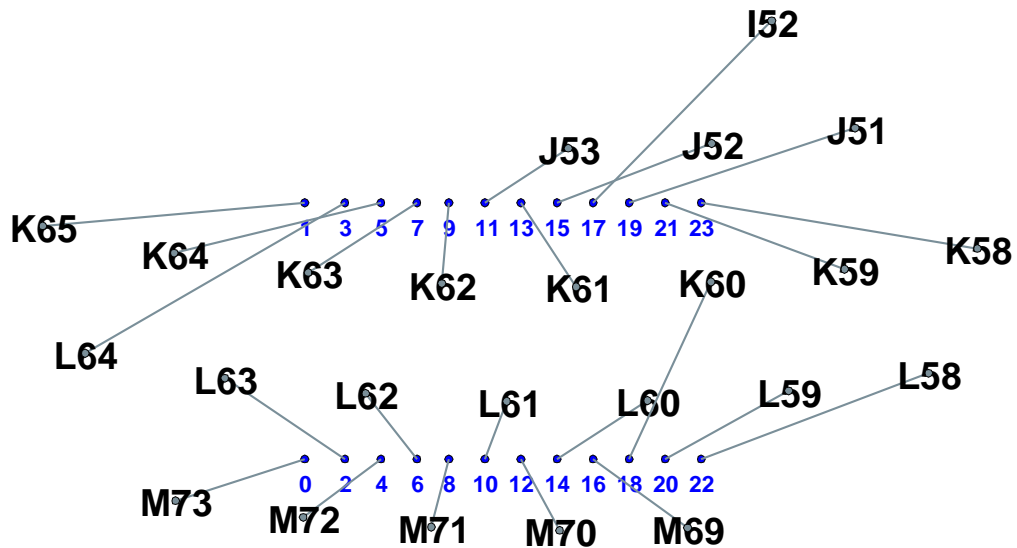

## D10

wire L71 ( 31, 57) pad 0 distance 44mm 1.7in +2.3= 4.07in wire 4.50in  
 wire K72 ( 25, 73) pad 1 distance 44mm 1.7in +2.3= 4.05in wire 4.50in  
 wire M82 ( 28, 41) pad 2 distance 45mm 1.8in +2.3= 4.11in wire 4.50in  
 wire K71 ( 42, 70) pad 3 distance 39mm 1.5in +2.3= 3.87in wire 4.00in  
 wire M81 ( 44, 38) pad 4 distance 39mm 1.5in +2.3= 3.85in wire 4.00in  
 wire L70 ( 48, 54) pad 5 distance 46mm 1.8in +2.3= 4.13in wire 4.50in  
 wire L69 ( 66, 52) pad 6 distance 33mm 1.3in +2.3= 3.64in wire 3.75in  
 wire J61 ( 58, 85) pad 7 distance 35mm 1.4in +2.3= 3.70in wire 3.75in  
 wire M80 ( 60, 37) pad 8 distance 36mm 1.4in +2.3= 3.75in wire 4.00in  
 wire K70 ( 58, 67) pad 9 distance 40mm 1.6in +2.3= 3.90in wire 4.00in  
 wire M79 ( 76, 35) pad 10 distance 33mm 1.3in +2.3= 3.63in wire 3.75in  
 wire I61 ( 68, 98) pad 11 distance 38mm 1.5in +2.3= 3.83in wire 4.00in  
 wire L68 ( 83, 51) pad 12 distance 36mm 1.4in +2.3= 3.74in wire 3.75in  
 wire K69 ( 75, 66) pad 13 distance 38mm 1.5in +2.3= 3.84in wire 4.00in  
 wire M78 ( 92, 35) pad 14 distance 33mm 1.3in +2.3= 3.62in wire 3.75in  
 wire J60 ( 76, 83) pad 15 distance 36mm 1.4in +2.3= 3.74in wire 3.75in  
 wire L67 (101, 51) pad 16 distance 36mm 1.4in +2.3= 3.75in wire 4.00in  
 wire K68 ( 92, 66) pad 17 distance 38mm 1.5in +2.3= 3.80in wire 4.00in  
 wire M77 (108, 36) pad 18 distance 34mm 1.3in +2.3= 3.65in wire 3.75in  
 wire K67 (109, 66) pad 19 distance 38mm 1.5in +2.3= 3.81in wire 4.00in  
 wire L66 (118, 52) pad 20 distance 38mm 1.5in +2.3= 3.82in wire 4.00in  
 wire K66 (125, 68) pad 21 distance 40mm 1.6in +2.3= 3.91in wire 4.00in  
 wire M76 (124, 37) pad 22 distance 35mm 1.4in +2.3= 3.71in wire 3.75in  
 wire L65 (136, 55) pad 23 distance 49mm 1.9in +2.3= 4.26in wire 4.50in

Longest wire L65 at 108.1mm 4.26in Mean dist 97.6mm 3.84in

8 3.75-inch wires 11 4-inch wires 5 4.5-inch wires 0 5-inch wires 0 longer wires

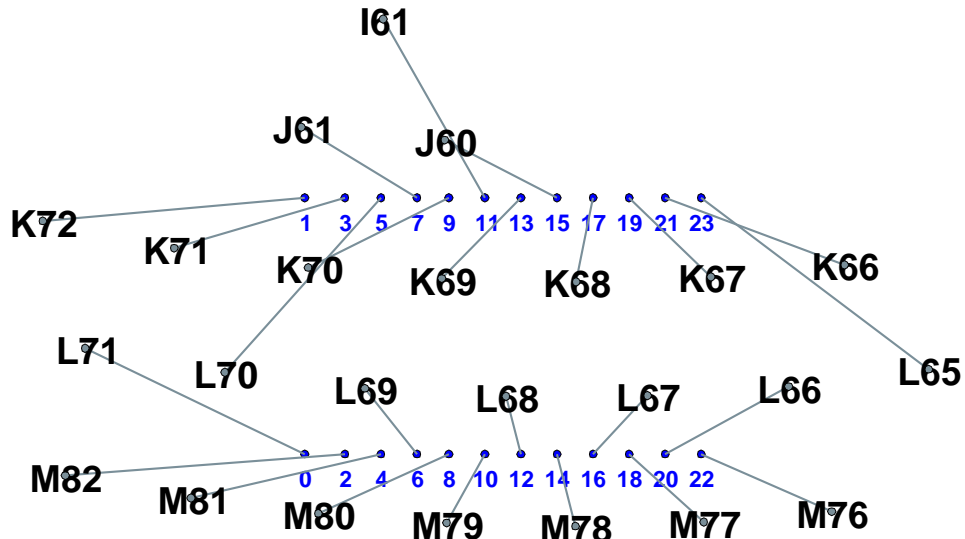

## D11

wire L79 ( 31, 57) pad 0 distance 44mm 1.7in +2.3= 4.07in wire 4.50in  
 wire K80 ( 25, 73) pad 1 distance 44mm 1.7in +2.3= 4.05in wire 4.50in  
 wire M91 ( 33, 40) pad 2 distance 42mm 1.7in +2.3= 3.99in wire 4.00in  
 wire J69 ( 40, 88) pad 3 distance 38mm 1.5in +2.3= 3.83in wire 4.00in  
 wire M90 ( 48, 38) pad 4 distance 37mm 1.4in +2.3= 3.76in wire 4.00in  
 wire K79 ( 42, 70) pad 5 distance 42mm 1.6in +2.3= 3.96in wire 4.00in  
 wire L78 ( 48, 54) pad 6 distance 40mm 1.6in +2.3= 3.88in wire 4.00in  
 wire J68 ( 58, 85) pad 7 distance 35mm 1.4in +2.3= 3.70in wire 3.75in  
 wire M89 ( 64, 36) pad 8 distance 35mm 1.4in +2.3= 3.69in wire 3.75in  
 wire K78 ( 58, 67) pad 9 distance 40mm 1.6in +2.3= 3.90in wire 4.00in  
 wire M88 ( 80, 35) pad 10 distance 33mm 1.3in +2.3= 3.62in wire 3.75in  
 wire L77 ( 66, 52) pad 11 distance 47mm 1.9in +2.3= 4.19in wire 4.50in  
 wire L76 ( 83, 51) pad 12 distance 36mm 1.4in +2.3= 3.74in wire 3.75in  
 wire K77 ( 75, 66) pad 13 distance 38mm 1.5in +2.3= 3.84in wire 4.00in  
 wire N88 ( 88, 21) pad 14 distance 37mm 1.4in +2.3= 3.77in wire 4.00in  
 wire K76 ( 92, 66) pad 15 distance 37mm 1.5in +2.3= 3.80in wire 4.00in  
 wire M87 ( 96, 35) pad 16 distance 33mm 1.3in +2.3= 3.62in wire 3.75in  
 wire L75 (101, 51) pad 17 distance 46mm 1.8in +2.3= 4.13in wire 4.50in  
 wire M86 (112, 36) pad 18 distance 35mm 1.4in +2.3= 3.70in wire 3.75in  
 wire K75 (109, 66) pad 19 distance 38mm 1.5in +2.3= 3.81in wire 4.00in  
 wire L74 (118, 52) pad 20 distance 38mm 1.5in +2.3= 3.82in wire 4.00in  
 wire K74 (125, 68) pad 21 distance 40mm 1.6in +2.3= 3.91in wire 4.00in  
 wire M85 (128, 37) pad 22 distance 37mm 1.5in +2.3= 3.77in wire 4.00in  
 wire L73 (136, 55) pad 23 distance 49mm 1.9in +2.3= 4.26in wire 4.50in

Longest wire L73 at 108.1mm 4.26in Mean dist 98.2mm 3.87in

6 3.75-inch wires 13 4-inch wires 5 4.5-inch wires 0 5-inch wires 0 longer wires

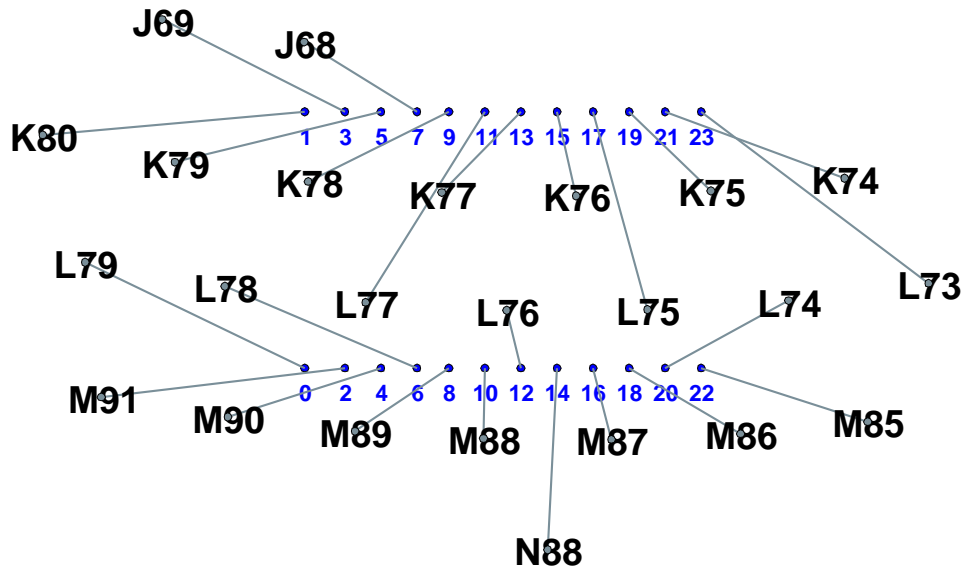

## D12

wire L87 ( 31, 57) pad 0 distance 44mm 1.7in +2.3= 4.07in wire 4.50in  
 wire K88 ( 25, 73) pad 1 distance 44mm 1.7in +2.3= 4.05in wire 4.50in  
 wire M100 ( 37, 40) pad 2 distance 40mm 1.6in +2.3= 3.89in wire 4.00in  
 wire K87 ( 42, 70) pad 3 distance 39mm 1.5in +2.3= 3.87in wire 4.00in  
 wire M99 ( 53, 37) pad 4 distance 35mm 1.4in +2.3= 3.69in wire 3.75in  
 wire L86 ( 48, 54) pad 5 distance 46mm 1.8in +2.3= 4.13in wire 4.50in  
 wire L85 ( 66, 52) pad 6 distance 33mm 1.3in +2.3= 3.64in wire 3.75in  
 wire K86 ( 58, 67) pad 7 distance 38mm 1.5in +2.3= 3.82in wire 4.00in  
 wire M98 ( 69, 36) pad 8 distance 34mm 1.3in +2.3= 3.65in wire 3.75in  
 wire K85 ( 75, 66) pad 9 distance 37mm 1.5in +2.3= 3.79in wire 4.00in  
 wire L84 ( 83, 51) pad 10 distance 36mm 1.4in +2.3= 3.74in wire 3.75in  
 wire M97 ( 85, 35) pad 12 distance 33mm 1.3in +2.3= 3.62in wire 3.75in  
 wire K84 ( 92, 66) pad 13 distance 38mm 1.5in +2.3= 3.82in wire 4.00in  
 wire M96 (101, 35) pad 14 distance 34mm 1.4in +2.3= 3.68in wire 3.75in  
 wire L83 (101, 51) pad 15 distance 47mm 1.9in +2.3= 4.18in wire 4.50in  
 wire N96 (110, 22) pad 16 distance 39mm 1.5in +2.3= 3.85in wire 4.00in  
 wire K83 (109, 66) pad 17 distance 39mm 1.5in +2.3= 3.87in wire 4.00in  
 wire M95 (117, 36) pad 18 distance 37mm 1.4in +2.3= 3.77in wire 4.00in  
 wire K82 (125, 68) pad 19 distance 44mm 1.7in +2.3= 4.05in wire 4.50in  
 wire L82 (118, 52) pad 20 distance 38mm 1.5in +2.3= 3.82in wire 4.00in  
 wire L81 (136, 54) pad 21 distance 52mm 2.0in +2.3= 4.36in wire 4.50in  
 wire M94 (133, 38) pad 22 distance 39mm 1.5in +2.3= 3.86in wire 4.00in  
 wire K81 (142, 70) pad 23 distance 46mm 1.8in +2.3= 4.14in wire 4.50in

Longest wire L81 at 110.8mm 4.36in Mean dist 98.7mm 3.88in

6 3.75-inch wires 10 4-inch wires 7 4.5-inch wires 0 5-inch wires 0 longer wires

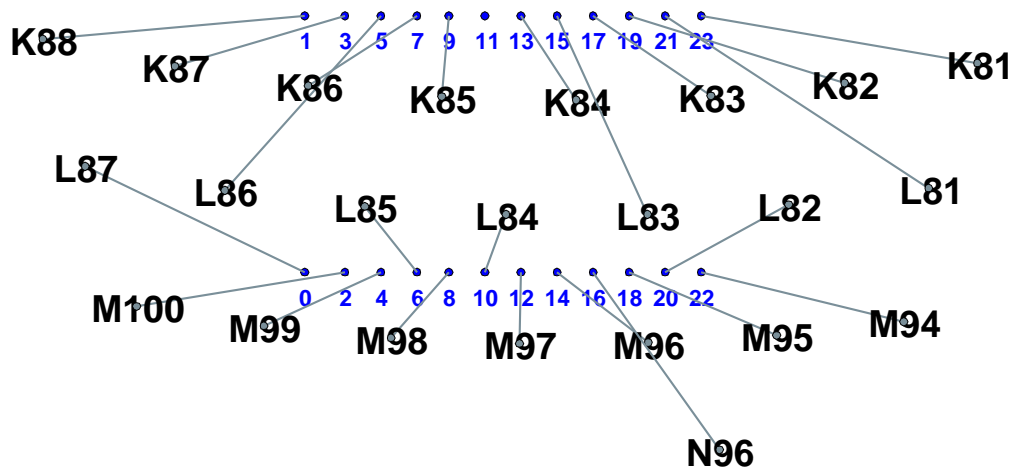



## D13

wire M110 ( 26, 42) pad 0 distance 43mm 1.7in +2.3= 4.04in wire 4.50in  
 wire K96 ( 25, 73) pad 1 distance 44mm 1.7in +2.3= 4.05in wire 4.50in  
 wire M109 ( 42, 39) pad 2 distance 37mm 1.5in +2.3= 3.79in wire 4.00in  
 wire L95 ( 31, 57) pad 3 distance 50mm 2.0in +2.3= 4.30in wire 4.50in  
 wire M108 ( 57, 37) pad 4 distance 34mm 1.3in +2.3= 3.65in wire 3.75in  
 wire K95 ( 42, 70) pad 5 distance 42mm 1.6in +2.3= 3.96in wire 4.00in  
 wire L93 ( 66, 52) pad 6 distance 33mm 1.3in +2.3= 3.64in wire 3.75in  
 wire L94 ( 48, 54) pad 7 distance 49mm 1.9in +2.3= 4.24in wire 4.50in  
 wire M107 ( 73, 36) pad 8 distance 33mm 1.3in +2.3= 3.62in wire 3.75in  
 wire K94 ( 58, 67) pad 9 distance 40mm 1.6in +2.3= 3.90in wire 4.00in  
 wire L92 ( 83, 51) pad 10 distance 36mm 1.4in +2.3= 3.74in wire 3.75in  
 wire K93 ( 75, 66) pad 11 distance 37mm 1.5in +2.3= 3.80in wire 4.00in  
 wire M106 ( 89, 35) pad 12 distance 33mm 1.3in +2.3= 3.64in wire 3.75in  
 wire K92 ( 92, 66) pad 13 distance 38mm 1.5in +2.3= 3.82in wire 4.00in  
 wire L91 (101, 51) pad 14 distance 37mm 1.5in +2.3= 3.79in wire 4.00in  
 wire K91 (109, 66) pad 15 distance 42mm 1.6in +2.3= 3.96in wire 4.00in  
 wire M105 (106, 35) pad 16 distance 34mm 1.4in +2.3= 3.68in wire 3.75in  
 wire J79 (112, 84) pad 17 distance 37mm 1.5in +2.3= 3.77in wire 4.00in  
 wire L90 (118, 52) pad 18 distance 40mm 1.6in +2.3= 3.90in wire 4.00in  
 wire K90 (125, 68) pad 19 distance 44mm 1.7in +2.3= 4.05in wire 4.50in  
 wire M104 (121, 37) pad 20 distance 36mm 1.4in +2.3= 3.76in wire 4.00in  
 wire J78 (130, 86) pad 21 distance 41mm 1.6in +2.3= 3.92in wire 4.00in  
 wire L89 (136, 55) pad 22 distance 44mm 1.7in +2.3= 4.04in wire 4.50in  
 wire K89 (142, 70) pad 23 distance 46mm 1.8in +2.3= 4.14in wire 4.50in

Longest wire L95 at 109.1mm 4.30in Mean dist 98.6mm 3.88in

6 3.75-inch wires 11 4-inch wires 7 4.5-inch wires 0 5-inch wires 0 longer wires

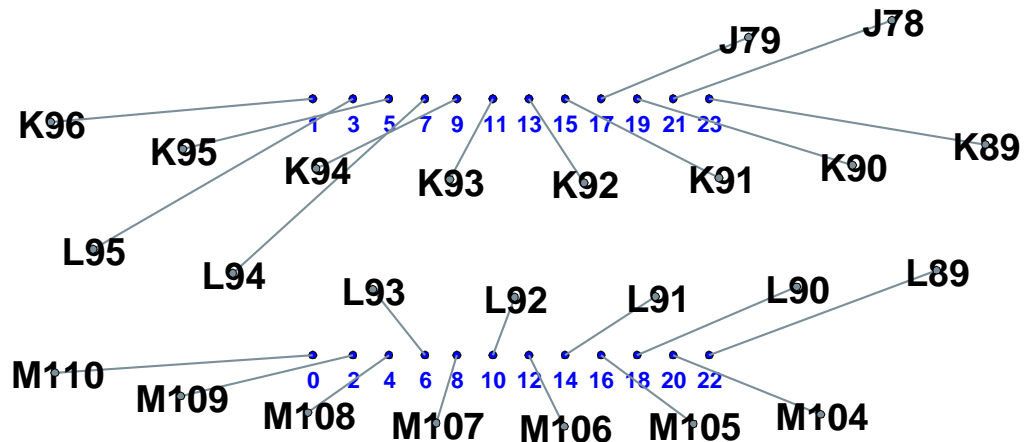

## D14

wire L102 ( 31, 57) pad 0 distance 44mm 1.7in +2.3= 4.07in wire 4.50in  
 wire L103 ( 13, 61) pad 1 distance 55mm 2.2in +2.3= 4.50in wire 4.50in  
 wire M117 ( 44, 38) pad 2 distance 36mm 1.4in +2.3= 3.76in wire 4.00in  
 wire K103 ( 25, 73) pad 3 distance 48mm 1.9in +2.3= 4.21in wire 4.50in  
 wire N117 ( 50, 24) pad 4 distance 39mm 1.5in +2.3= 3.84in wire 4.00in  
 wire K102 ( 42, 70) pad 5 distance 42mm 1.6in +2.3= 3.96in wire 4.00in  
 wire L100 ( 66, 52) pad 6 distance 33mm 1.3in +2.3= 3.64in wire 3.75in  
 wire L101 ( 48, 54) pad 7 distance 49mm 1.9in +2.3= 4.24in wire 4.50in  
 wire M116 ( 59, 37) pad 8 distance 37mm 1.4in +2.3= 3.76in wire 4.00in  
 wire K101 ( 58, 67) pad 9 distance 40mm 1.6in +2.3= 3.90in wire 4.00in  
 wire M115 ( 75, 35) pad 10 distance 33mm 1.3in +2.3= 3.64in wire 3.75in  
 wire K100 ( 75, 66) pad 11 distance 37mm 1.5in +2.3= 3.80in wire 4.00in  
 wire L99 ( 83, 51) pad 12 distance 36mm 1.4in +2.3= 3.74in wire 3.75in  
 wire J87 ( 79, 83) pad 13 distance 34mm 1.3in +2.3= 3.64in wire 3.75in  
 wire M114 ( 91, 35) pad 14 distance 33mm 1.3in +2.3= 3.62in wire 3.75in  
 wire K99 ( 92, 66) pad 15 distance 37mm 1.5in +2.3= 3.80in wire 4.00in  
 wire L98 (101, 51) pad 16 distance 36mm 1.4in +2.3= 3.75in wire 4.00in  
 wire J86 ( 97, 83) pad 17 distance 33mm 1.3in +2.3= 3.62in wire 3.75in  
 wire M113 (108, 36) pad 18 distance 34mm 1.3in +2.3= 3.65in wire 3.75in  
 wire K98 (109, 66) pad 19 distance 38mm 1.5in +2.3= 3.81in wire 4.00in  
 wire L97 (118, 52) pad 20 distance 38mm 1.5in +2.3= 3.82in wire 4.00in  
 wire J85 (115, 84) pad 21 distance 34mm 1.3in +2.3= 3.66in wire 3.75in  
 wire L96 (136, 55) pad 22 distance 44mm 1.7in +2.3= 4.04in wire 4.50in  
 wire K97 (125, 68) pad 23 distance 38mm 1.5in +2.3= 3.83in wire 4.00in

Longest wire L103 at 114.2mm 4.50in Mean dist 97.7mm 3.85in

8 3.75-inch wires 11 4-inch wires 5 4.5-inch wires 0 5-inch wires 0 longer wires

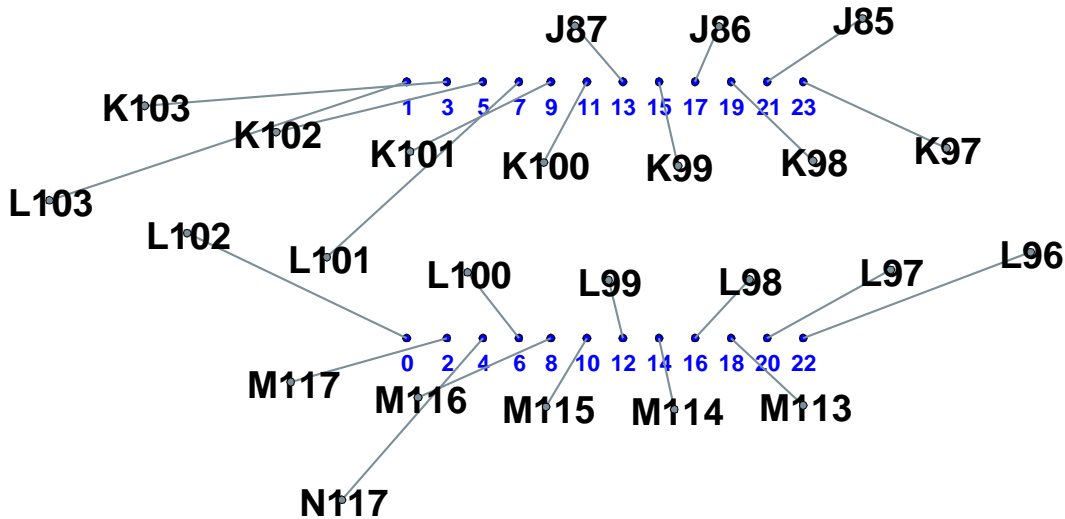

# E1

wire P8 ( 21, 42) pad 0 distance 47mm 1.8in +2.3= 4.17in wire 4.50in  
 wire O8 ( 31, 54) pad 1 distance 48mm 1.9in +2.3= 4.20in wire 4.50in  
 wire P7 ( 37, 40) pad 2 distance 39mm 1.6in +2.3= 3.88in wire 4.00in  
 wire N7 ( 37, 70) pad 3 distance 41mm 1.6in +2.3= 3.95in wire 4.00in  
 wire P6 ( 54, 38) pad 4 distance 34mm 1.4in +2.3= 3.68in wire 3.75in  
 wire O7 ( 47, 52) pad 5 distance 48mm 1.9in +2.3= 4.20in wire 4.50in  
 wire O6 ( 63, 51) pad 6 distance 34mm 1.3in +2.3= 3.65in wire 3.75in  
 wire N6 ( 54, 68) pad 7 distance 39mm 1.5in +2.3= 3.86in wire 4.00in  
 wire P5 ( 71, 37) pad 8 distance 33mm 1.3in +2.3= 3.63in wire 3.75in  
 wire M5 ( 63, 82) pad 9 distance 35mm 1.4in +2.3= 3.71in wire 3.75in  
 wire O5 ( 79, 50) pad 10 distance 36mm 1.4in +2.3= 3.73in wire 3.75in  
 wire N5 ( 70, 67) pad 11 distance 38mm 1.5in +2.3= 3.81in wire 4.00in  
 wire P4 ( 87, 37) pad 12 distance 33mm 1.3in +2.3= 3.63in wire 3.75in  
 wire N4 ( 87, 67) pad 13 distance 37mm 1.4in +2.3= 3.77in wire 4.00in  
 wire Q4 ( 96, 12) pad 14 distance 42mm 1.6in +2.3= 3.96in wire 4.00in  
 wire O4 ( 95, 51) pad 15 distance 47mm 1.8in +2.3= 4.15in wire 4.50in  
 wire P3 (104, 37) pad 16 distance 34mm 1.3in +2.3= 3.66in wire 3.75in  
 wire N3 (104, 68) pad 17 distance 37mm 1.5in +2.3= 3.79in wire 4.00in  
 wire O3 (111, 52) pad 18 distance 37mm 1.5in +2.3= 3.78in wire 4.00in  
 wire N2 (121, 69) pad 19 distance 41mm 1.6in +2.3= 3.93in wire 4.00in  
 wire P2 (120, 39) pad 20 distance 36mm 1.4in +2.3= 3.74in wire 3.75in  
 wire O2 (127, 53) pad 21 distance 48mm 1.9in +2.3= 4.22in wire 4.50in  
 wire P1 (137, 41) pad 22 distance 42mm 1.6in +2.3= 3.96in wire 4.00in  
 wire N1 (137, 72) pad 23 distance 43mm 1.7in +2.3= 4.01in wire 4.50in

Longest wire O2 at 107.1mm 4.22in Mean dist 98.5mm 3.88in

8 3.75-inch wires 10 4-inch wires 6 4.5-inch wires 0 5-inch wires 0 longer wires

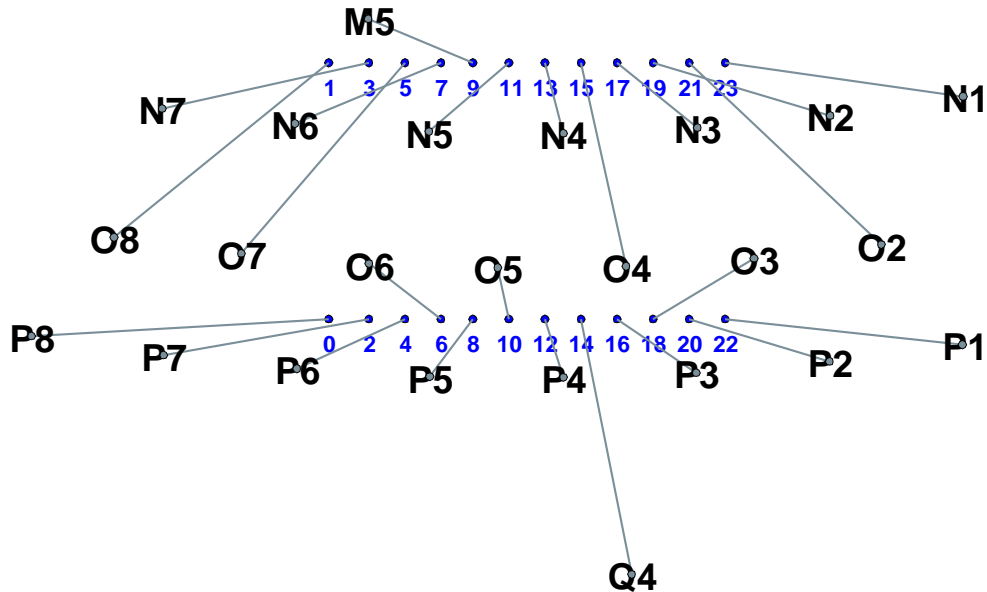

## E2

wire O16 ( 31, 55) pad 0 distance 43mm 1.7in +2.3= 4.02in wire 4.50in  
 wire N15 ( 26, 73) pad 1 distance 44mm 1.7in +2.3= 4.05in wire 4.50in  
 wire O15 ( 47, 53) pad 2 distance 38mm 1.5in +2.3= 3.82in wire 4.00in  
 wire M14 ( 36, 85) pad 3 distance 40mm 1.6in +2.3= 3.91in wire 4.00in  
 wire P14 ( 54, 38) pad 4 distance 34mm 1.4in +2.3= 3.68in wire 3.75in  
 wire N14 ( 42, 70) pad 5 distance 41mm 1.6in +2.3= 3.95in wire 4.00in  
 wire O14 ( 63, 51) pad 6 distance 34mm 1.3in +2.3= 3.65in wire 3.75in  
 wire L12 ( 45,100) pad 7 distance 44mm 1.7in +2.3= 4.07in wire 4.50in  
 wire P13 ( 71, 37) pad 8 distance 33mm 1.3in +2.3= 3.63in wire 3.75in  
 wire M13 ( 52, 83) pad 9 distance 40mm 1.6in +2.3= 3.91in wire 4.00in  
 wire O13 ( 79, 51) pad 10 distance 36mm 1.4in +2.3= 3.73in wire 3.75in  
 wire N13 ( 59, 68) pad 11 distance 42mm 1.6in +2.3= 3.97in wire 4.00in  
 wire P12 ( 87, 37) pad 12 distance 33mm 1.3in +2.3= 3.63in wire 3.75in  
 wire N12 ( 75, 68) pad 13 distance 38mm 1.5in +2.3= 3.81in wire 4.00in  
 wire O12 ( 95, 51) pad 14 distance 36mm 1.4in +2.3= 3.74in wire 3.75in  
 wire N11 ( 92, 68) pad 15 distance 36mm 1.4in +2.3= 3.76in wire 4.00in  
 wire P11 (104, 38) pad 16 distance 34mm 1.3in +2.3= 3.66in wire 3.75in  
 wire N10 (109, 68) pad 17 distance 38mm 1.5in +2.3= 3.83in wire 4.00in  
 wire O11 (111, 52) pad 18 distance 37mm 1.5in +2.3= 3.79in wire 4.00in  
 wire N9 (126, 70) pad 19 distance 43mm 1.7in +2.3= 4.02in wire 4.50in  
 wire P10 (120, 39) pad 20 distance 36mm 1.4in +2.3= 3.74in wire 3.75in  
 wire O10 (127, 54) pad 21 distance 48mm 1.9in +2.3= 4.21in wire 4.50in  
 wire P9 (137, 41) pad 22 distance 42mm 1.6in +2.3= 3.96in wire 4.00in  
 wire O9 (143, 56) pad 23 distance 52mm 2.1in +2.3= 4.38in wire 4.50in

Longest wire O9 at 111.2mm 4.38in Mean dist 98.3mm 3.87in

8 3.75-inch wires 10 4-inch wires 6 4.5-inch wires 0 5-inch wires 0 longer wires

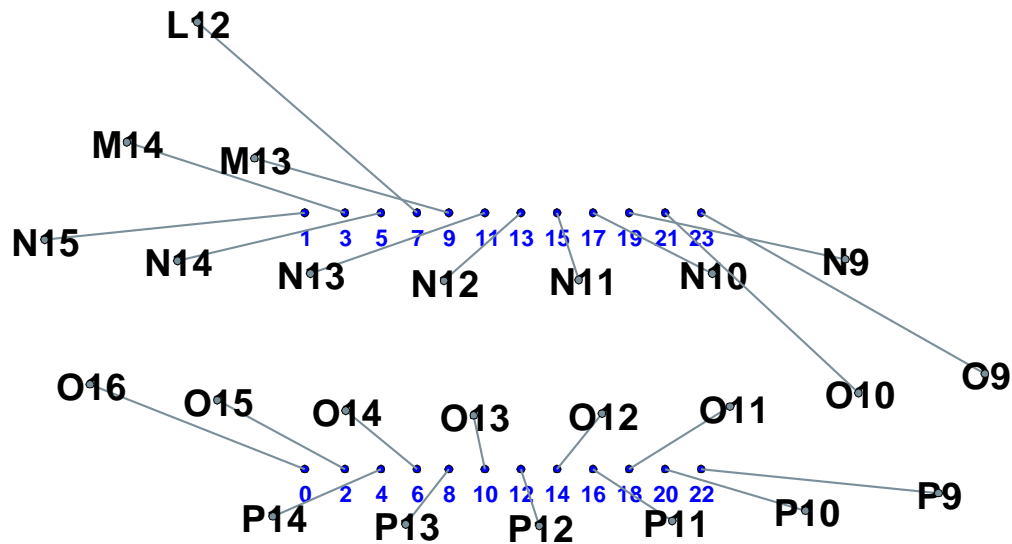

### E3

wire P24 ( 21, 42) pad 0 distance 47mm 1.8in +2.3= 4.17in wire 4.50in  
 wire O24 ( 31, 54) pad 1 distance 48mm 1.9in +2.3= 4.21in wire 4.50in  
 wire P23 ( 37, 39) pad 2 distance 40mm 1.6in +2.3= 3.88in wire 4.00in  
 wire N22 ( 30, 71) pad 3 distance 45mm 1.8in +2.3= 4.10in wire 4.50in  
 wire P22 ( 54, 38) pad 4 distance 35mm 1.4in +2.3= 3.68in wire 3.75in  
 wire O23 ( 47, 52) pad 5 distance 48mm 1.9in +2.3= 4.20in wire 4.50in  
 wire O22 ( 63, 51) pad 6 distance 34mm 1.3in +2.3= 3.65in wire 3.75in  
 wire N21 ( 47, 69) pad 7 distance 42mm 1.7in +2.3= 3.98in wire 4.00in  
 wire P21 ( 71, 37) pad 8 distance 33mm 1.3in +2.3= 3.63in wire 3.75in  
 wire N20 ( 64, 68) pad 9 distance 38mm 1.5in +2.3= 3.83in wire 4.00in  
 wire O21 ( 79, 50) pad 10 distance 36mm 1.4in +2.3= 3.72in wire 3.75in  
 wire N19 ( 80, 67) pad 11 distance 37mm 1.4in +2.3= 3.77in wire 4.00in  
 wire P20 ( 87, 36) pad 12 distance 33mm 1.3in +2.3= 3.63in wire 3.75in  
 wire O20 ( 95, 50) pad 14 distance 36mm 1.4in +2.3= 3.74in wire 3.75in  
 wire N18 ( 97, 67) pad 15 distance 37mm 1.5in +2.3= 3.79in wire 4.00in  
 wire P19 (104, 37) pad 16 distance 34mm 1.3in +2.3= 3.66in wire 3.75in  
 wire N17 (114, 68) pad 17 distance 40mm 1.6in +2.3= 3.90in wire 4.00in  
 wire O19 (111, 51) pad 18 distance 37mm 1.5in +2.3= 3.78in wire 4.00in  
 wire O18 (127, 53) pad 19 distance 52mm 2.0in +2.3= 4.35in wire 4.50in  
 wire P18 (120, 38) pad 20 distance 36mm 1.4in +2.3= 3.74in wire 3.75in  
 wire N16 (130, 70) pad 21 distance 42mm 1.7in +2.3= 3.97in wire 4.00in  
 wire P17 (137, 41) pad 22 distance 41mm 1.6in +2.3= 3.95in wire 4.00in  
 wire O17 (143, 56) pad 23 distance 52mm 2.1in +2.3= 4.38in wire 4.50in

Longest wire O17 at 111.3mm 4.38in Mean dist 99.1mm 3.90in

8 3.75-inch wires 9 4-inch wires 6 4.5-inch wires 0 5-inch wires 0 longer wires

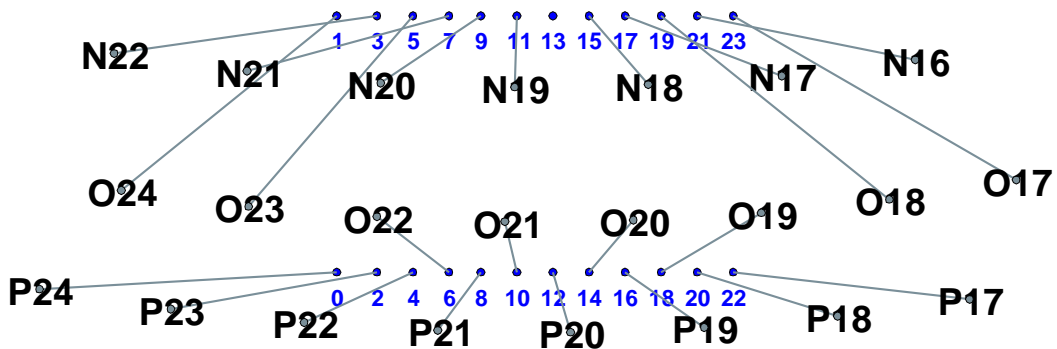

## E4

wire P32 ( 21, 42) pad 0 distance 47mm 1.8in +2.3= 4.17in wire 4.50in  
 wire O32 ( 31, 54) pad 1 distance 48mm 1.9in +2.3= 4.20in wire 4.50in  
 wire P31 ( 37, 39) pad 2 distance 40mm 1.6in +2.3= 3.88in wire 4.00in  
 wire N29 ( 35, 71) pad 3 distance 42mm 1.7in +2.3= 3.99in wire 4.00in  
 wire P30 ( 54, 38) pad 4 distance 35mm 1.4in +2.3= 3.68in wire 3.75in  
 wire O31 ( 47, 52) pad 5 distance 48mm 1.9in +2.3= 4.20in wire 4.50in  
 wire O30 ( 63, 51) pad 6 distance 34mm 1.3in +2.3= 3.65in wire 3.75in  
 wire N28 ( 52, 68) pad 7 distance 40mm 1.6in +2.3= 3.90in wire 4.00in  
 wire P29 ( 70, 36) pad 8 distance 33mm 1.3in +2.3= 3.63in wire 3.75in  
 wire N27 ( 68, 67) pad 9 distance 37mm 1.5in +2.3= 3.79in wire 4.00in  
 wire O29 ( 79, 50) pad 10 distance 35mm 1.4in +2.3= 3.72in wire 3.75in  
 wire N26 ( 85, 67) pad 11 distance 37mm 1.5in +2.3= 3.78in wire 4.00in  
 wire P28 ( 87, 36) pad 12 distance 33mm 1.3in +2.3= 3.63in wire 3.75in  
 wire O28 ( 95, 50) pad 13 distance 48mm 1.9in +2.3= 4.20in wire 4.50in  
 wire P27 (104, 37) pad 14 distance 35mm 1.4in +2.3= 3.72in wire 3.75in  
 wire N25 (102, 67) pad 15 distance 38mm 1.5in +2.3= 3.84in wire 4.00in  
 wire O27 (111, 51) pad 16 distance 39mm 1.5in +2.3= 3.85in wire 4.00in  
 wire N24 (118, 68) pad 17 distance 42mm 1.7in +2.3= 4.00in wire 4.00in  
 wire P26 (120, 38) pad 18 distance 38mm 1.5in +2.3= 3.83in wire 4.00in  
 wire M23 (125, 83) pad 19 distance 41mm 1.6in +2.3= 3.93in wire 4.00in  
 wire O26 (127, 52) pad 20 distance 42mm 1.6in +2.3= 3.97in wire 4.00in  
 wire N23 (135, 71) pad 21 distance 45mm 1.8in +2.3= 4.09in wire 4.50in  
 wire P25 (137, 40) pad 22 distance 41mm 1.6in +2.3= 3.95in wire 4.00in  
 wire O25 (143, 55) pad 23 distance 53mm 2.1in +2.3= 4.40in wire 4.50in

Longest wire O25 at 111.7mm 4.40in Mean dist 99.5mm 3.92in

6 3.75-inch wires 12 4-inch wires 6 4.5-inch wires 0 5-inch wires 0 longer wires

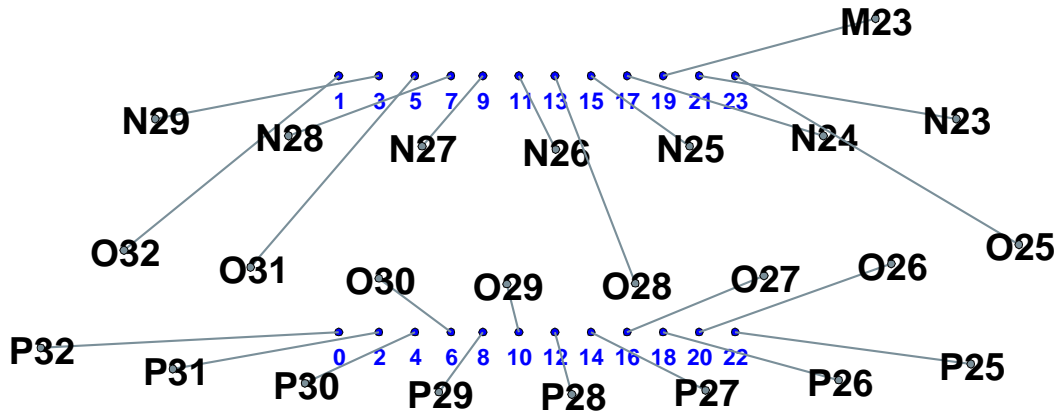

## E5

wire P39 ( 37, 40) pad 0 distance 37mm 1.5in +2.3= 3.78in wire 4.00in  
 wire O40 ( 31, 55) pad 1 distance 47mm 1.9in +2.3= 4.19in wire 4.50in  
 wire P38 ( 54, 38) pad 2 distance 33mm 1.3in +2.3= 3.64in wire 3.75in  
 wire N36 ( 40, 70) pad 3 distance 40mm 1.6in +2.3= 3.89in wire 4.00in  
 wire P37 ( 70, 37) pad 4 distance 34mm 1.3in +2.3= 3.65in wire 3.75in  
 wire O39 ( 47, 52) pad 5 distance 47mm 1.9in +2.3= 4.19in wire 4.50in  
 wire O38 ( 63, 51) pad 6 distance 34mm 1.3in +2.3= 3.65in wire 3.75in  
 wire N35 ( 57, 68) pad 7 distance 38mm 1.5in +2.3= 3.83in wire 4.00in  
 wire O37 ( 79, 50) pad 8 distance 36mm 1.4in +2.3= 3.73in wire 3.75in  
 wire N34 ( 73, 67) pad 9 distance 37mm 1.4in +2.3= 3.76in wire 4.00in  
 wire P36 ( 87, 36) pad 10 distance 34mm 1.3in +2.3= 3.65in wire 3.75in  
 wire M33 ( 82, 81) pad 11 distance 33mm 1.3in +2.3= 3.63in wire 3.75in  
 wire O36 ( 95, 50) pad 12 distance 37mm 1.5in +2.3= 3.78in wire 4.00in  
 wire N33 ( 90, 67) pad 13 distance 37mm 1.5in +2.3= 3.78in wire 4.00in  
 wire P35 (104, 37) pad 14 distance 35mm 1.4in +2.3= 3.72in wire 3.75in  
 wire M32 ( 98, 81) pad 15 distance 34mm 1.3in +2.3= 3.66in wire 3.75in  
 wire N32 (107, 68) pad 16 distance 46mm 1.8in +2.3= 4.15in wire 4.50in  
 wire L27 (113, 98) pad 17 distance 40mm 1.6in +2.3= 3.89in wire 4.00in  
 wire O35 (111, 51) pad 18 distance 37mm 1.5in +2.3= 3.78in wire 4.00in  
 wire M31 (114, 82) pad 19 distance 35mm 1.4in +2.3= 3.72in wire 3.75in  
 wire O34 (127, 53) pad 20 distance 42mm 1.6in +2.3= 3.97in wire 4.00in  
 wire N31 (123, 69) pad 21 distance 39mm 1.5in +2.3= 3.86in wire 4.00in  
 wire O33 (143, 55) pad 22 distance 48mm 1.9in +2.3= 4.21in wire 4.50in  
 wire N30 (140, 72) pad 23 distance 45mm 1.8in +2.3= 4.08in wire 4.50in

Longest wire O33 at 107.0mm 4.21in Mean dist 97.6mm 3.84in

9 3.75-inch wires 10 4-inch wires 5 4.5-inch wires 0 5-inch wires 0 longer wires

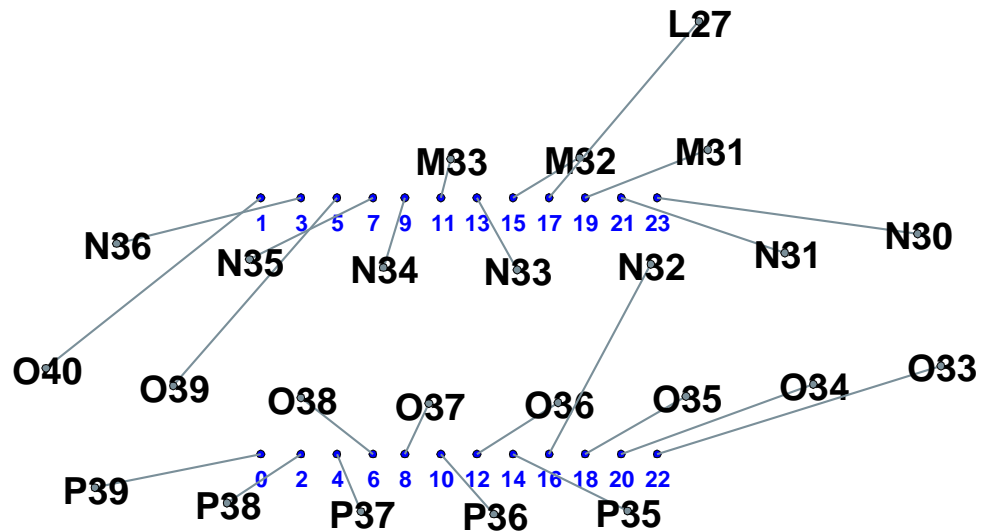

## E6

wire P47 ( 37, 40) pad 0 distance 37mm 1.5in +2.3= 3.78in wire 4.00in  
 wire O48 ( 31, 54) pad 1 distance 48mm 1.9in +2.3= 4.20in wire 4.50in  
 wire O47 ( 47, 52) pad 2 distance 38mm 1.5in +2.3= 3.81in wire 4.00in  
 wire N44 ( 28, 72) pad 3 distance 46mm 1.8in +2.3= 4.14in wire 4.50in  
 wire P46 ( 54, 38) pad 4 distance 35mm 1.4in +2.3= 3.68in wire 3.75in  
 wire N43 ( 45, 69) pad 5 distance 40mm 1.6in +2.3= 3.91in wire 4.00in  
 wire O46 ( 63, 51) pad 6 distance 34mm 1.3in +2.3= 3.65in wire 3.75in  
 wire N42 ( 61, 68) pad 7 distance 37mm 1.5in +2.3= 3.79in wire 4.00in  
 wire P45 ( 70, 36) pad 8 distance 33mm 1.3in +2.3= 3.64in wire 3.75in  
 wire M41 ( 70, 81) pad 9 distance 33mm 1.3in +2.3= 3.64in wire 3.75in  
 wire O45 ( 79, 50) pad 10 distance 35mm 1.4in +2.3= 3.72in wire 3.75in  
 wire N41 ( 78, 67) pad 11 distance 37mm 1.5in +2.3= 3.77in wire 4.00in  
 wire P44 ( 87, 36) pad 12 distance 33mm 1.3in +2.3= 3.62in wire 3.75in  
 wire M40 ( 86, 80) pad 13 distance 33mm 1.3in +2.3= 3.63in wire 3.75in  
 wire O44 ( 95, 50) pad 14 distance 36mm 1.4in +2.3= 3.73in wire 3.75in  
 wire N40 ( 95, 67) pad 15 distance 37mm 1.5in +2.3= 3.78in wire 4.00in  
 wire P43 (104, 36) pad 16 distance 34mm 1.3in +2.3= 3.66in wire 3.75in  
 wire M39 (102, 81) pad 17 distance 34mm 1.3in +2.3= 3.65in wire 3.75in  
 wire O43 (111, 51) pad 18 distance 37mm 1.4in +2.3= 3.77in wire 4.00in  
 wire N39 (112, 68) pad 19 distance 38mm 1.5in +2.3= 3.82in wire 4.00in  
 wire P42 (120, 38) pad 20 distance 36mm 1.4in +2.3= 3.74in wire 3.75in  
 wire N38 (128, 69) pad 21 distance 41mm 1.6in +2.3= 3.95in wire 4.00in  
 wire O42 (127, 52) pad 22 distance 39mm 1.5in +2.3= 3.84in wire 4.00in  
 wire O41 (143, 54) pad 23 distance 53mm 2.1in +2.3= 4.41in wire 4.50in

Longest wire O41 at 111.9mm 4.41in Mean dist 96.6mm 3.81in

11 3.75-inch wires 10 4-inch wires 3 4.5-inch wires 0 5-inch wires 0 longer wires

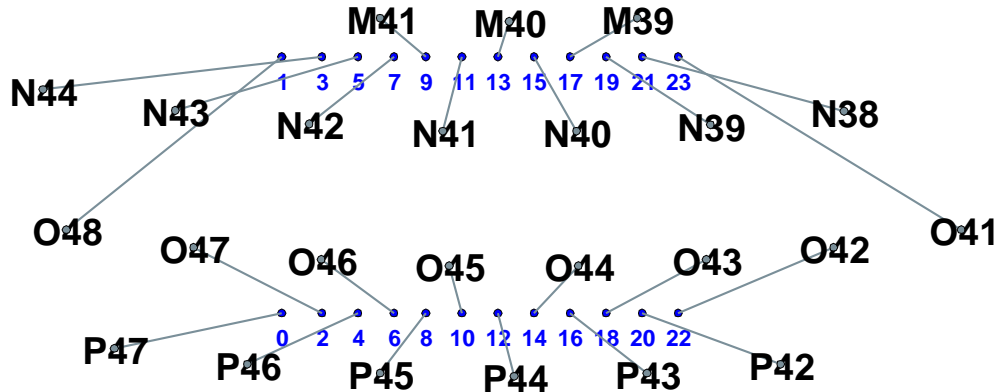



## E7

wire P55 ( 38, 40) pad 0 distance 37mm 1.5in +2.3= 3.78in wire 4.00in  
 wire O56 ( 31, 54) pad 1 distance 48mm 1.9in +2.3= 4.20in wire 4.50in  
 wire O55 ( 47, 52) pad 2 distance 38mm 1.5in +2.3= 3.81in wire 4.00in  
 wire N51 ( 33, 71) pad 3 distance 44mm 1.7in +2.3= 4.04in wire 4.50in  
 wire P54 ( 54, 38) pad 4 distance 34mm 1.4in +2.3= 3.68in wire 3.75in  
 wire N50 ( 49, 69) pad 5 distance 38mm 1.5in +2.3= 3.83in wire 4.00in  
 wire O54 ( 63, 51) pad 6 distance 34mm 1.3in +2.3= 3.65in wire 3.75in  
 wire M49 ( 59, 82) pad 7 distance 35mm 1.4in +2.3= 3.68in wire 3.75in  
 wire P53 ( 71, 37) pad 8 distance 33mm 1.3in +2.3= 3.63in wire 3.75in  
 wire N49 ( 66, 68) pad 9 distance 37mm 1.5in +2.3= 3.80in wire 4.00in  
 wire O53 ( 79, 50) pad 10 distance 36mm 1.4in +2.3= 3.73in wire 3.75in  
 wire L42 ( 69, 97) pad 11 distance 38mm 1.5in +2.3= 3.80in wire 4.00in  
 wire P52 ( 87, 37) pad 12 distance 33mm 1.3in +2.3= 3.63in wire 3.75in  
 wire M48 ( 75, 81) pad 13 distance 35mm 1.4in +2.3= 3.69in wire 3.75in  
 wire O52 ( 95, 51) pad 14 distance 36mm 1.4in +2.3= 3.74in wire 3.75in  
 wire N48 ( 83, 67) pad 15 distance 37mm 1.5in +2.3= 3.79in wire 4.00in  
 wire P51 (104, 37) pad 16 distance 34mm 1.3in +2.3= 3.66in wire 3.75in  
 wire N47 (100, 68) pad 17 distance 37mm 1.4in +2.3= 3.76in wire 4.00in  
 wire O51 (111, 52) pad 18 distance 37mm 1.5in +2.3= 3.79in wire 4.00in  
 wire N46 (116, 69) pad 19 distance 39mm 1.5in +2.3= 3.86in wire 4.00in  
 wire P50 (121, 39) pad 20 distance 36mm 1.4in +2.3= 3.74in wire 3.75in  
 wire N45 (133, 71) pad 21 distance 43mm 1.7in +2.3= 4.03in wire 4.50in  
 wire O50 (127, 53) pad 22 distance 39mm 1.5in +2.3= 3.86in wire 4.00in  
 wire O49 (143, 56) pad 23 distance 52mm 2.1in +2.3= 4.38in wire 4.50in

Longest wire O49 at 111.2mm 4.38in Mean dist 96.9mm 3.81in

10 3.75-inch wires 10 4-inch wires 4 4.5-inch wires 0 5-inch wires 0 longer wires

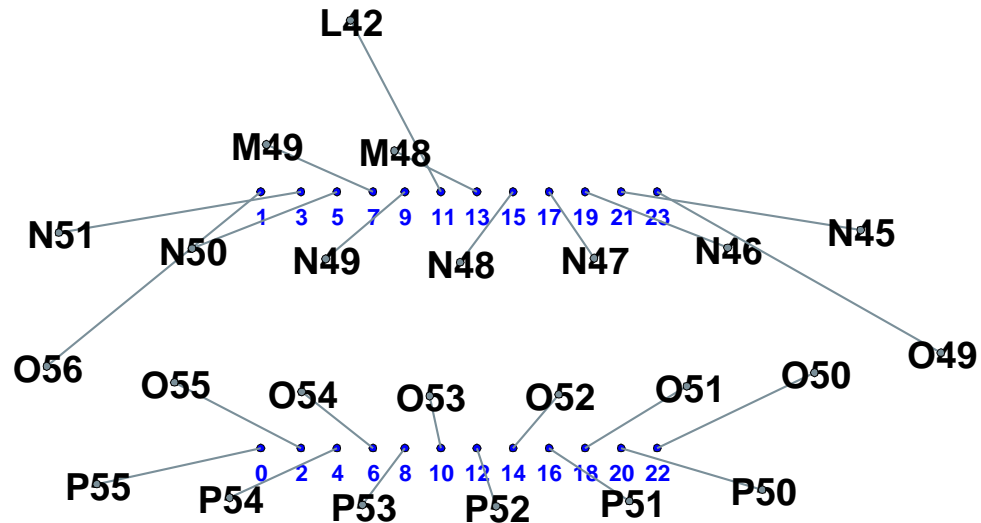

## E8

wire O64 ( 31, 54) pad 0 distance 43mm 1.7in +2.3= 4.02in wire 4.50in  
 wire N59 ( 21, 73) pad 1 distance 46mm 1.8in +2.3= 4.15in wire 4.50in  
 wire O63 ( 47, 52) pad 2 distance 38mm 1.5in +2.3= 3.81in wire 4.00in  
 wire N58 ( 38, 70) pad 3 distance 41mm 1.6in +2.3= 3.93in wire 4.00in  
 wire P62 ( 54, 38) pad 4 distance 35mm 1.4in +2.3= 3.69in wire 3.75in  
 wire M57 ( 48, 83) pad 5 distance 37mm 1.4in +2.3= 3.77in wire 4.00in  
 wire O62 ( 63, 50) pad 6 distance 34mm 1.3in +2.3= 3.65in wire 3.75in  
 wire N57 ( 54, 68) pad 7 distance 39mm 1.5in +2.3= 3.86in wire 4.00in  
 wire P61 ( 70, 36) pad 8 distance 33mm 1.3in +2.3= 3.64in wire 3.75in  
 wire M56 ( 64, 81) pad 9 distance 35mm 1.4in +2.3= 3.70in wire 3.75in  
 wire O61 ( 79, 50) pad 10 distance 35mm 1.4in +2.3= 3.72in wire 3.75in  
 wire N56 ( 71, 67) pad 11 distance 38mm 1.5in +2.3= 3.81in wire 4.00in  
 wire P60 ( 87, 36) pad 12 distance 33mm 1.3in +2.3= 3.63in wire 3.75in  
 wire M55 ( 80, 80) pad 13 distance 34mm 1.3in +2.3= 3.64in wire 3.75in  
 wire Q65 ( 88, 11) pad 14 distance 42mm 1.7in +2.3= 3.98in wire 4.00in  
 wire N55 ( 88, 66) pad 15 distance 37mm 1.5in +2.3= 3.78in wire 4.00in  
 wire O60 ( 95, 50) pad 16 distance 35mm 1.4in +2.3= 3.71in wire 3.75in  
 wire P59 (104, 36) pad 18 distance 33mm 1.3in +2.3= 3.63in wire 3.75in  
 wire N54 (104, 67) pad 19 distance 37mm 1.5in +2.3= 3.78in wire 4.00in  
 wire Q64 (104, 11) pad 20 distance 42mm 1.7in +2.3= 3.99in wire 4.00in  
 wire O59 (111, 50) pad 21 distance 46mm 1.8in +2.3= 4.13in wire 4.50in  
 wire P58 (120, 37) pad 22 distance 34mm 1.3in +2.3= 3.66in wire 3.75in  
 wire O58 (127, 52) pad 23 distance 47mm 1.9in +2.3= 4.18in wire 4.50in

Longest wire O58 at 106.2mm 4.18in Mean dist 97.0mm 3.82in

10 3.75-inch wires 9 4-inch wires 4 4.5-inch wires 0 5-inch wires 0 longer wires

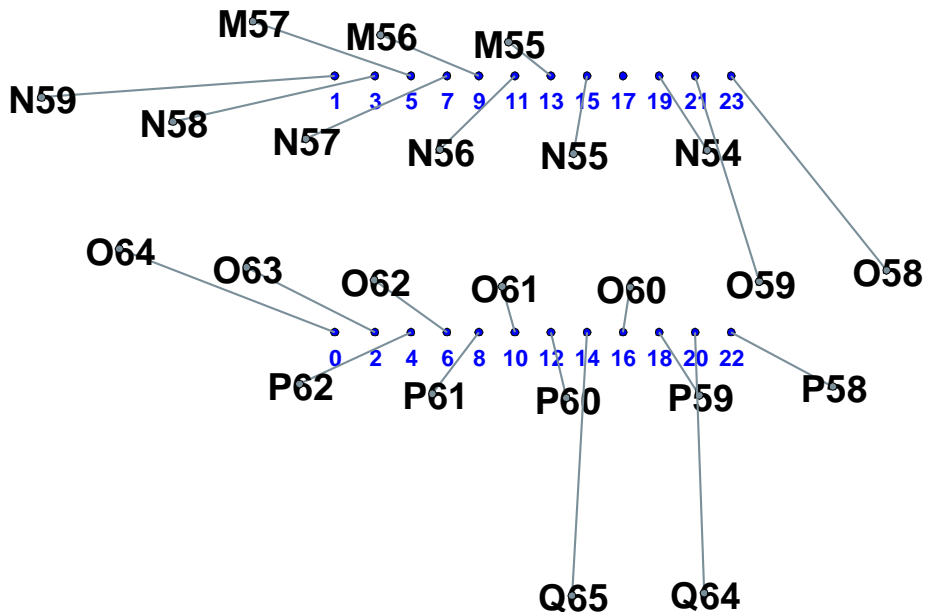

## E9

wire O72 ( 31, 55) pad 0 distance 43mm 1.7in +2.3= 4.02in wire 4.50in  
 wire N66 ( 26, 73) pad 1 distance 43mm 1.7in +2.3= 4.03in wire 4.50in  
 wire P71 ( 37, 40) pad 2 distance 40mm 1.6in +2.3= 3.88in wire 4.00in  
 wire N65 ( 43, 70) pad 3 distance 39mm 1.5in +2.3= 3.85in wire 4.00in  
 wire P70 ( 54, 38) pad 4 distance 35mm 1.4in +2.3= 3.69in wire 3.75in  
 wire O71 ( 47, 52) pad 5 distance 47mm 1.9in +2.3= 4.19in wire 4.50in  
 wire O70 ( 63, 51) pad 6 distance 34mm 1.3in +2.3= 3.65in wire 3.75in  
 wire N64 ( 59, 68) pad 7 distance 38mm 1.5in +2.3= 3.80in wire 4.00in  
 wire P69 ( 70, 37) pad 8 distance 33mm 1.3in +2.3= 3.64in wire 3.75in  
 wire N63 ( 76, 67) pad 9 distance 37mm 1.4in +2.3= 3.77in wire 4.00in  
 wire O69 ( 79, 50) pad 10 distance 36mm 1.4in +2.3= 3.72in wire 3.75in  
 wire P68 ( 87, 36) pad 12 distance 33mm 1.3in +2.3= 3.62in wire 3.75in  
 wire O68 ( 95, 50) pad 14 distance 36mm 1.4in +2.3= 3.73in wire 3.75in  
 wire N62 ( 93, 67) pad 15 distance 37mm 1.5in +2.3= 3.78in wire 4.00in  
 wire P67 (104, 36) pad 16 distance 34mm 1.3in +2.3= 3.66in wire 3.75in  
 wire N61 (109, 67) pad 17 distance 39mm 1.5in +2.3= 3.86in wire 4.00in  
 wire O67 (111, 51) pad 18 distance 37mm 1.4in +2.3= 3.77in wire 4.00in  
 wire N60 (126, 69) pad 19 distance 44mm 1.7in +2.3= 4.05in wire 4.50in  
 wire P66 (120, 38) pad 20 distance 36mm 1.4in +2.3= 3.74in wire 3.75in  
 wire O66 (127, 52) pad 21 distance 49mm 1.9in +2.3= 4.25in wire 4.50in  
 wire P65 (137, 39) pad 22 distance 41mm 1.6in +2.3= 3.95in wire 4.00in  
 wire O65 (143, 54) pad 23 distance 53mm 2.1in +2.3= 4.41in wire 4.50in

Longest wire O65 at 112.1mm 4.41in Mean dist 98.2mm 3.87in

8 3.75-inch wires 8 4-inch wires 6 4.5-inch wires 0 5-inch wires 0 longer wires

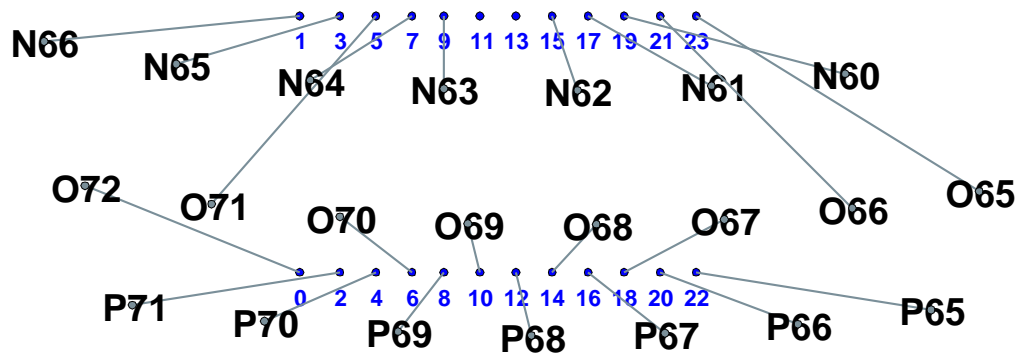

## E10

wire O79 ( 46, 52) pad 0 distance 36mm 1.4in +2.3= 3.75in wire 3.75in  
 wire O80 ( 30, 53) pad 1 distance 49mm 1.9in +2.3= 4.24in wire 4.50in  
 wire P78 ( 54, 37) pad 2 distance 33mm 1.3in +2.3= 3.64in wire 3.75in  
 wire N73 ( 30, 70) pad 3 distance 46mm 1.8in +2.3= 4.12in wire 4.50in  
 wire P77 ( 70, 36) pad 4 distance 34mm 1.3in +2.3= 3.65in wire 3.75in  
 wire N72 ( 46, 68) pad 5 distance 40mm 1.6in +2.3= 3.89in wire 4.00in  
 wire O78 ( 62, 51) pad 6 distance 34mm 1.3in +2.3= 3.65in wire 3.75in  
 wire N71 ( 63, 67) pad 7 distance 37mm 1.5in +2.3= 3.78in wire 4.00in  
 wire O77 ( 78, 50) pad 8 distance 36mm 1.4in +2.3= 3.73in wire 3.75in  
 wire N70 ( 80, 67) pad 9 distance 37mm 1.5in +2.3= 3.78in wire 4.00in  
 wire P76 ( 87, 37) pad 10 distance 34mm 1.3in +2.3= 3.65in wire 3.75in  
 wire N69 ( 96, 68) pad 11 distance 40mm 1.6in +2.3= 3.90in wire 4.00in  
 wire O76 ( 94, 51) pad 12 distance 37mm 1.5in +2.3= 3.78in wire 4.00in  
 wire M68 (104, 82) pad 13 distance 38mm 1.5in +2.3= 3.81in wire 4.00in  
 wire P75 (103, 37) pad 14 distance 35mm 1.4in +2.3= 3.71in wire 3.75in  
 wire N68 (113, 69) pad 15 distance 43mm 1.7in +2.3= 4.00in wire 4.50in  
 wire O75 (110, 52) pad 16 distance 39mm 1.5in +2.3= 3.86in wire 4.00in  
 wire M67 (119, 84) pad 17 distance 40mm 1.6in +2.3= 3.92in wire 4.00in  
 wire P74 (120, 39) pad 18 distance 38mm 1.5in +2.3= 3.82in wire 4.00in  
 wire N67 (130, 71) pad 19 distance 45mm 1.8in +2.3= 4.10in wire 4.50in  
 wire O74 (126, 54) pad 20 distance 42mm 1.6in +2.3= 3.97in wire 4.00in  
 wire M66 (135, 86) pad 21 distance 44mm 1.7in +2.3= 4.04in wire 4.50in  
 wire P73 (136, 41) pad 22 distance 41mm 1.6in +2.3= 3.94in wire 4.00in  
 wire O73 (142, 56) pad 23 distance 51mm 2.0in +2.3= 4.35in wire 4.50in

Longest wire O73 at 110.5mm 4.35in Mean dist 98.5mm 3.88in

7 3.75-inch wires 11 4-inch wires 6 4.5-inch wires 0 5-inch wires 0 longer wires

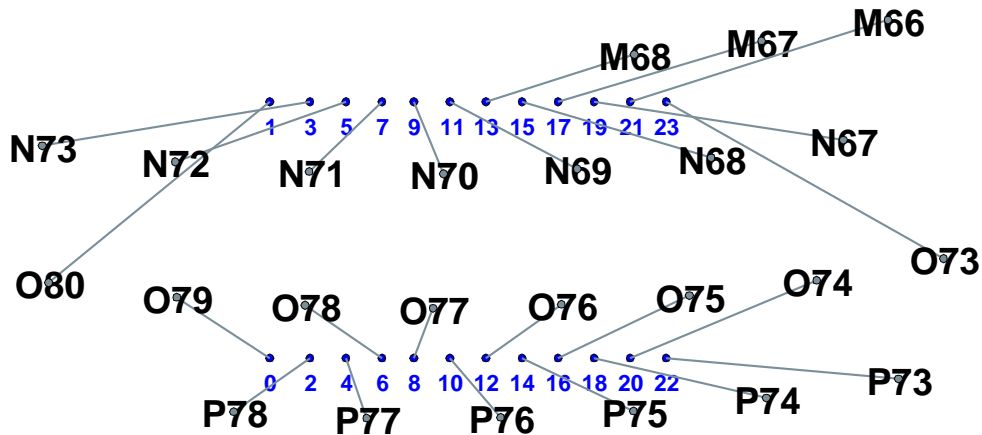

## E11

wire P88 ( 21, 42) pad 0 distance 47mm 1.8in +2.3= 4.17in wire 4.50in  
 wire O88 ( 31, 54) pad 1 distance 48mm 1.9in +2.3= 4.20in wire 4.50in  
 wire P87 ( 37, 40) pad 2 distance 40mm 1.6in +2.3= 3.88in wire 4.00in  
 wire N80 ( 36, 71) pad 3 distance 42mm 1.7in +2.3= 3.98in wire 4.00in  
 wire P86 ( 54, 38) pad 4 distance 35mm 1.4in +2.3= 3.68in wire 3.75in  
 wire O87 ( 47, 52) pad 5 distance 48mm 1.9in +2.3= 4.20in wire 4.50in  
 wire O86 ( 63, 51) pad 6 distance 34mm 1.3in +2.3= 3.65in wire 3.75in  
 wire N79 ( 52, 68) pad 7 distance 40mm 1.6in +2.3= 3.89in wire 4.00in  
 wire P85 ( 70, 37) pad 8 distance 33mm 1.3in +2.3= 3.63in wire 3.75in  
 wire N78 ( 69, 67) pad 9 distance 37mm 1.5in +2.3= 3.78in wire 4.00in  
 wire O85 ( 79, 50) pad 10 distance 36mm 1.4in +2.3= 3.72in wire 3.75in  
 wire N77 ( 86, 67) pad 11 distance 37mm 1.5in +2.3= 3.79in wire 4.00in  
 wire O84 ( 95, 50) pad 12 distance 37mm 1.5in +2.3= 3.78in wire 4.00in  
 wire N76 (102, 67) pad 13 distance 40mm 1.6in +2.3= 3.91in wire 4.00in  
 wire P83 (104, 37) pad 14 distance 35mm 1.4in +2.3= 3.72in wire 3.75in  
 wire M75 (110, 82) pad 15 distance 38mm 1.5in +2.3= 3.83in wire 4.00in  
 wire O83 (111, 51) pad 16 distance 39mm 1.5in +2.3= 3.86in wire 4.00in  
 wire N75 (119, 69) pad 17 distance 43mm 1.7in +2.3= 4.00in wire 4.50in  
 wire P82 (120, 38) pad 18 distance 38mm 1.5in +2.3= 3.83in wire 4.00in  
 wire M74 (125, 83) pad 19 distance 41mm 1.6in +2.3= 3.94in wire 4.00in  
 wire O82 (127, 53) pad 20 distance 42mm 1.6in +2.3= 3.97in wire 4.00in  
 wire N74 (136, 71) pad 21 distance 45mm 1.8in +2.3= 4.10in wire 4.50in  
 wire P81 (137, 40) pad 22 distance 41mm 1.6in +2.3= 3.95in wire 4.00in  
 wire O81 (143, 55) pad 23 distance 53mm 2.1in +2.3= 4.40in wire 4.50in

Longest wire O81 at 111.7mm 4.40in Mean dist 99.3mm 3.91in

5 3.75-inch wires 13 4-inch wires 6 4.5-inch wires 0 5-inch wires 0 longer wires

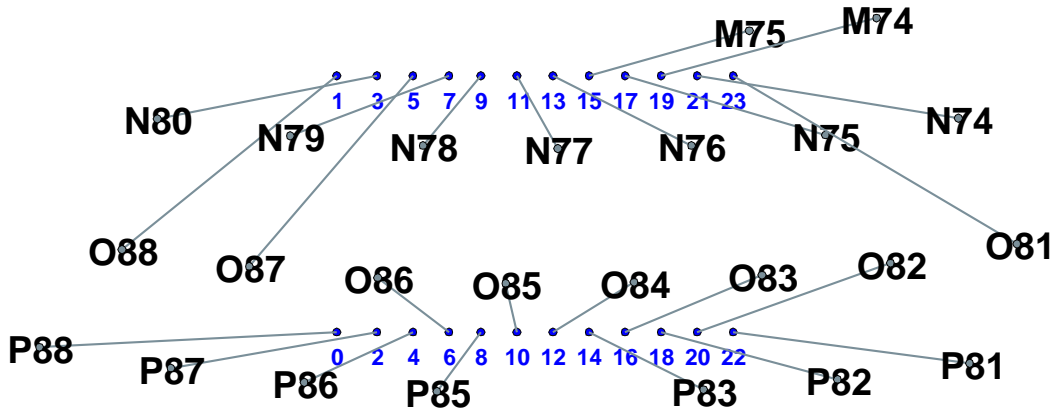

## E12

wire P95 ( 37, 40) pad 0 distance 37mm 1.5in +2.3= 3.78in wire 4.00in  
 wire O96 ( 31, 55) pad 1 distance 47mm 1.9in +2.3= 4.19in wire 4.50in  
 wire O95 ( 47, 52) pad 2 distance 38mm 1.5in +2.3= 3.82in wire 4.00in  
 wire N87 ( 41, 70) pad 3 distance 40mm 1.6in +2.3= 3.88in wire 4.00in  
 wire P94 ( 54, 38) pad 4 distance 35mm 1.4in +2.3= 3.69in wire 3.75in  
 wire N86 ( 57, 68) pad 5 distance 37mm 1.4in +2.3= 3.76in wire 4.00in  
 wire O94 ( 63, 51) pad 6 distance 34mm 1.3in +2.3= 3.65in wire 3.75in  
 wire N85 ( 74, 67) pad 7 distance 37mm 1.5in +2.3= 3.78in wire 4.00in  
 wire P93 ( 70, 36) pad 8 distance 33mm 1.3in +2.3= 3.64in wire 3.75in  
 wire M84 ( 82, 80) pad 9 distance 34mm 1.3in +2.3= 3.66in wire 3.75in  
 wire O93 ( 79, 50) pad 10 distance 35mm 1.4in +2.3= 3.72in wire 3.75in  
 wire N84 ( 91, 66) pad 11 distance 39mm 1.5in +2.3= 3.84in wire 4.00in  
 wire O92 ( 95, 49) pad 12 distance 37mm 1.4in +2.3= 3.76in wire 4.00in  
 wire L72 ( 95, 96) pad 13 distance 37mm 1.5in +2.3= 3.77in wire 4.00in  
 wire P91 (103, 36) pad 14 distance 35mm 1.4in +2.3= 3.71in wire 3.75in  
 wire M83 ( 98, 80) pad 15 distance 34mm 1.3in +2.3= 3.67in wire 3.75in  
 wire O91 (111, 50) pad 16 distance 38mm 1.5in +2.3= 3.84in wire 4.00in  
 wire N83 (107, 66) pad 17 distance 39mm 1.5in +2.3= 3.84in wire 4.00in  
 wire P90 (120, 37) pad 18 distance 38mm 1.5in +2.3= 3.82in wire 4.00in  
 wire N82 (124, 68) pad 19 distance 43mm 1.7in +2.3= 4.02in wire 4.50in  
 wire O90 (127, 51) pad 20 distance 41mm 1.6in +2.3= 3.95in wire 4.00in  
 wire N81 (141, 70) pad 21 distance 49mm 1.9in +2.3= 4.24in wire 4.50in  
 wire P89 (137, 38) pad 22 distance 41mm 1.6in +2.3= 3.94in wire 4.00in  
 wire O89 (143, 53) pad 23 distance 54mm 2.1in +2.3= 4.43in wire 4.50in

Longest wire O89 at 112.5mm 4.43in Mean dist 97.8mm 3.85in

7 3.75-inch wires 13 4-inch wires 4 4.5-inch wires 0 5-inch wires 0 longer wires

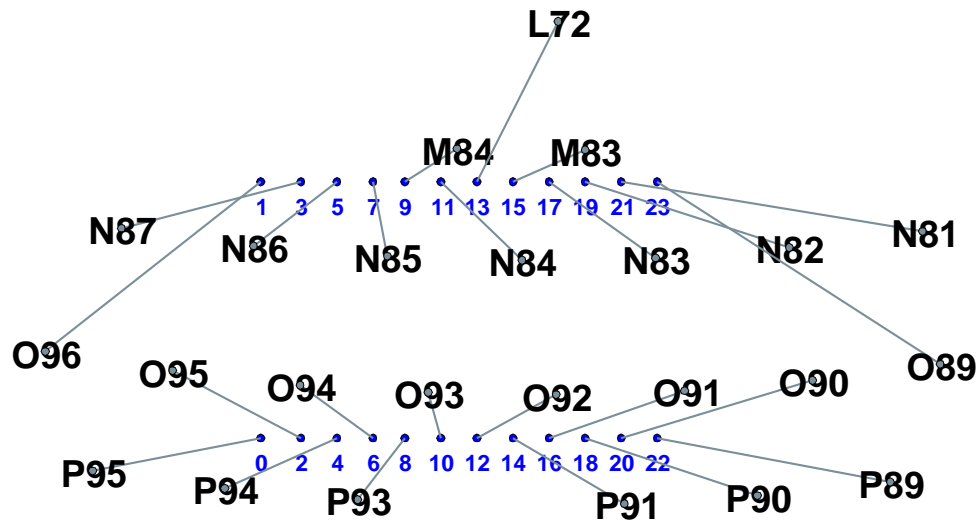

### E13

wire O104 ( 31, 54) pad 0 distance 43mm 1.7in +2.3= 4.01in wire 4.50in  
 wire N95 ( 28, 72) pad 1 distance 42mm 1.7in +2.3= 3.99in wire 4.00in  
 wire P103 ( 38, 40) pad 2 distance 39mm 1.6in +2.3= 3.87in wire 4.00in  
 wire N94 ( 45, 69) pad 3 distance 38mm 1.5in +2.3= 3.82in wire 4.00in  
 wire P102 ( 54, 38) pad 4 distance 34mm 1.4in +2.3= 3.68in wire 3.75in  
 wire M93 ( 54, 82) pad 5 distance 34mm 1.4in +2.3= 3.68in wire 3.75in  
 wire O103 ( 47, 52) pad 6 distance 40mm 1.6in +2.3= 3.89in wire 4.00in  
 wire N93 ( 62, 68) pad 7 distance 37mm 1.5in +2.3= 3.78in wire 4.00in  
 wire O102 ( 63, 51) pad 8 distance 38mm 1.5in +2.3= 3.81in wire 4.00in  
 wire L80 ( 64, 98) pad 9 distance 38mm 1.5in +2.3= 3.82in wire 4.00in  
 wire P101 ( 71, 37) pad 10 distance 34mm 1.3in +2.3= 3.67in wire 3.75in  
 wire M92 ( 70, 81) pad 11 distance 34mm 1.4in +2.3= 3.68in wire 3.75in  
 wire O101 ( 79, 51) pad 12 distance 36mm 1.4in +2.3= 3.75in wire 3.75in  
 wire N92 ( 78, 67) pad 13 distance 37mm 1.5in +2.3= 3.78in wire 4.00in  
 wire P100 ( 87, 37) pad 14 distance 33mm 1.3in +2.3= 3.63in wire 3.75in  
 wire N91 ( 95, 68) pad 15 distance 37mm 1.4in +2.3= 3.77in wire 4.00in  
 wire P99 (104, 38) pad 16 distance 34mm 1.3in +2.3= 3.66in wire 3.75in  
 wire O100 ( 95, 51) pad 17 distance 46mm 1.8in +2.3= 4.14in wire 4.50in  
 wire O99 (111, 52) pad 18 distance 37mm 1.5in +2.3= 3.79in wire 4.00in  
 wire N90 (112, 69) pad 19 distance 38mm 1.5in +2.3= 3.80in wire 4.00in  
 wire P98 (121, 39) pad 20 distance 36mm 1.4in +2.3= 3.75in wire 3.75in  
 wire N89 (128, 71) pad 21 distance 41mm 1.6in +2.3= 3.93in wire 4.00in  
 wire O98 (127, 54) pad 22 distance 39mm 1.5in +2.3= 3.86in wire 4.00in  
 wire O97 (143, 56) pad 23 distance 52mm 2.0in +2.3= 4.37in wire 4.50in

Longest wire O97 at 111.1mm 4.37in Mean dist 97.3mm 3.83in

8 3.75-inch wires 13 4-inch wires 3 4.5-inch wires 0 5-inch wires 0 longer wires

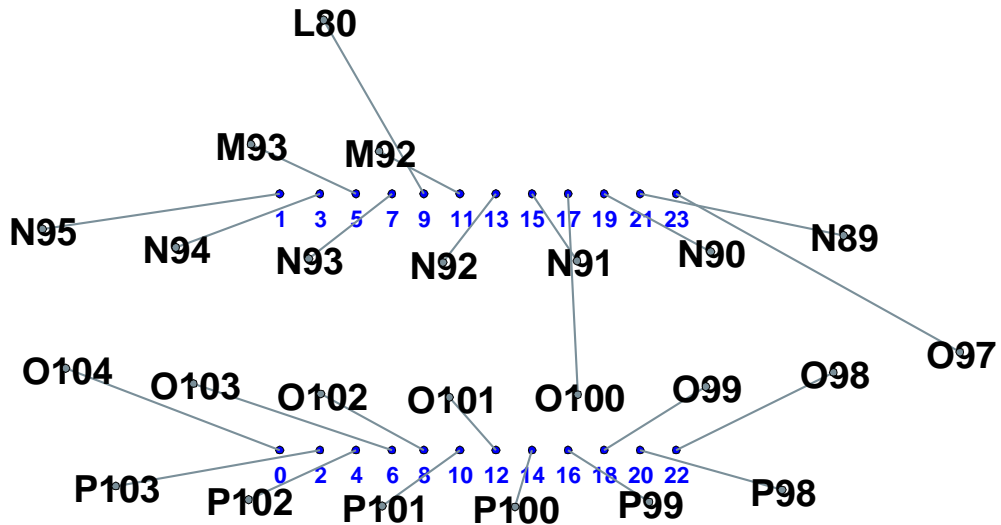

## E14

wire P112 ( 21, 42) pad 0 distance 47mm 1.8in +2.3= 4.16in wire 4.50in  
 wire M102 ( 27, 86) pad 1 distance 42mm 1.7in +2.3= 3.98in wire 4.00in  
 wire O112 ( 31, 54) pad 2 distance 46mm 1.8in +2.3= 4.14in wire 4.50in  
 wire N102 ( 33, 71) pad 3 distance 43mm 1.7in +2.3= 4.03in wire 4.50in  
 wire P111 ( 37, 40) pad 4 distance 42mm 1.7in +2.3= 3.99in wire 4.00in  
 wire L88 ( 33,101) pad 5 distance 49mm 1.9in +2.3= 4.25in wire 4.50in  
 wire O111 ( 47, 52) pad 6 distance 40mm 1.6in +2.3= 3.89in wire 4.00in  
 wire M101 ( 43, 83) pad 7 distance 42mm 1.7in +2.3= 3.97in wire 4.00in  
 wire P110 ( 54, 38) pad 8 distance 39mm 1.5in +2.3= 3.86in wire 4.00in  
 wire N101 ( 50, 69) pad 9 distance 44mm 1.7in +2.3= 4.05in wire 4.50in  
 wire P109 ( 71, 37) pad 10 distance 34mm 1.3in +2.3= 3.67in wire 3.75in  
 wire O110 ( 63, 51) pad 11 distance 49mm 1.9in +2.3= 4.25in wire 4.50in  
 wire O109 ( 79, 50) pad 12 distance 36mm 1.4in +2.3= 3.74in wire 3.75in  
 wire N100 ( 66, 68) pad 13 distance 41mm 1.6in +2.3= 3.93in wire 4.00in  
 wire P108 ( 87, 37) pad 14 distance 33mm 1.3in +2.3= 3.63in wire 3.75in  
 wire N99 ( 83, 67) pad 15 distance 37mm 1.5in +2.3= 3.79in wire 4.00in  
 wire O108 ( 95, 51) pad 16 distance 36mm 1.4in +2.3= 3.73in wire 3.75in  
 wire P107 (104, 37) pad 18 distance 33mm 1.3in +2.3= 3.63in wire 3.75in  
 wire N98 (100, 68) pad 19 distance 36mm 1.4in +2.3= 3.76in wire 4.00in  
 wire O107 (111, 52) pad 20 distance 36mm 1.4in +2.3= 3.74in wire 3.75in  
 wire N97 (117, 69) pad 21 distance 37mm 1.4in +2.3= 3.77in wire 4.00in  
 wire O106 (127, 53) pad 22 distance 39mm 1.5in +2.3= 3.86in wire 4.00in  
 wire O105 (143, 56) pad 23 distance 52mm 2.1in +2.3= 4.38in wire 4.50in

Longest wire O105 at 111.2mm 4.38in Mean dist 99.6mm 3.92in

6 3.75-inch wires 10 4-inch wires 7 4.5-inch wires 0 5-inch wires 0 longer wires

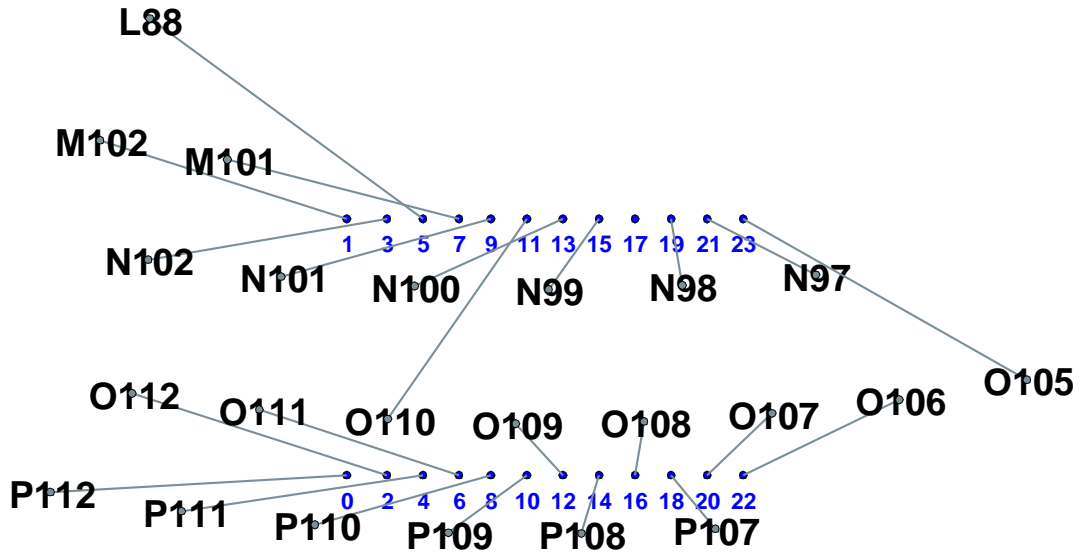



## E15

wire P119 ( 37, 40) pad 0 distance 37mm 1.5in +2.3= 3.79in wire 4.00in  
 wire O120 ( 31, 55) pad 1 distance 48mm 1.9in +2.3= 4.20in wire 4.50in  
 wire P118 ( 53, 37) pad 2 distance 33mm 1.3in +2.3= 3.64in wire 3.75in  
 wire N109 ( 38, 70) pad 3 distance 41mm 1.6in +2.3= 3.92in wire 4.00in  
 wire Q127 ( 63, 12) pad 4 distance 42mm 1.7in +2.3= 3.99in wire 4.00in  
 wire O119 ( 47, 52) pad 5 distance 48mm 1.9in +2.3= 4.20in wire 4.50in  
 wire O118 ( 63, 50) pad 6 distance 34mm 1.3in +2.3= 3.65in wire 3.75in  
 wire N108 ( 55, 68) pad 7 distance 39mm 1.5in +2.3= 3.85in wire 4.00in  
 wire P117 ( 70, 36) pad 8 distance 33mm 1.3in +2.3= 3.64in wire 3.75in  
 wire N107 ( 72, 66) pad 9 distance 37mm 1.5in +2.3= 3.78in wire 4.00in  
 wire Q126 ( 80, 10) pad 10 distance 42mm 1.7in +2.3= 3.99in wire 4.00in  
 wire O117 ( 79, 49) pad 11 distance 47mm 1.9in +2.3= 4.19in wire 4.50in  
 wire P116 ( 86, 35) pad 12 distance 33mm 1.3in +2.3= 3.63in wire 3.75in  
 wire N106 ( 88, 66) pad 13 distance 38mm 1.5in +2.3= 3.80in wire 4.00in  
 wire P115 (103, 35) pad 14 distance 35mm 1.4in +2.3= 3.71in wire 3.75in  
 wire O116 ( 95, 49) pad 15 distance 48mm 1.9in +2.3= 4.21in wire 4.50in  
 wire O115 (111, 49) pad 16 distance 38mm 1.5in +2.3= 3.83in wire 4.00in  
 wire N105 (105, 66) pad 17 distance 38mm 1.5in +2.3= 3.83in wire 4.00in  
 wire P114 (120, 36) pad 18 distance 38mm 1.5in +2.3= 3.82in wire 4.00in  
 wire N104 (122, 67) pad 19 distance 42mm 1.7in +2.3= 3.99in wire 4.00in  
 wire O114 (127, 50) pad 20 distance 41mm 1.6in +2.3= 3.93in wire 4.00in  
 wire M103 (129, 81) pad 21 distance 39mm 1.6in +2.3= 3.88in wire 4.00in  
 wire O113 (143, 52) pad 22 distance 47mm 1.9in +2.3= 4.17in wire 4.50in  
 wire N103 (138, 68) pad 23 distance 44mm 1.8in +2.3= 4.07in wire 4.50in

Longest wire O116 at 106.8mm 4.21in Mean dist 99.2mm 3.90in

5 3.75-inch wires 13 4-inch wires 6 4.5-inch wires 0 5-inch wires 0 longer wires

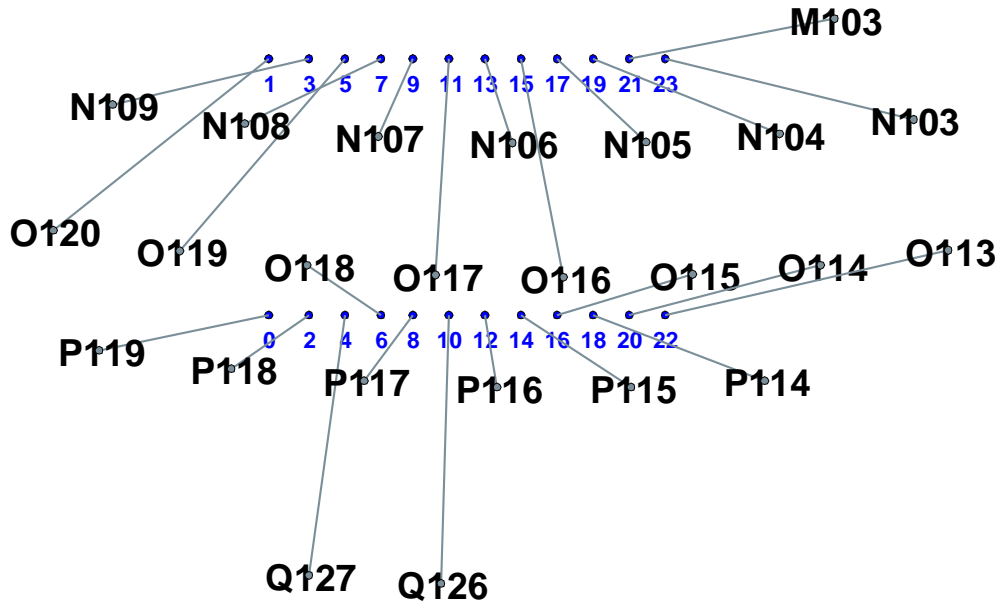

## E16

wire O127 ( 37, 50) pad 0 distance 39mm 1.5in +2.3= 3.84in wire 4.00in  
 wire O128 ( 21, 52) pad 1 distance 54mm 2.1in +2.3= 4.46in wire 4.50in  
 wire P126 ( 44, 36) pad 2 distance 36mm 1.4in +2.3= 3.75in wire 3.75in  
 wire N116 ( 33, 67) pad 3 distance 45mm 1.8in +2.3= 4.08in wire 4.50in  
 wire P125 ( 61, 35) pad 4 distance 33mm 1.3in +2.3= 3.63in wire 3.75in  
 wire N115 ( 49, 66) pad 5 distance 40mm 1.6in +2.3= 3.88in wire 4.00in  
 wire O126 ( 53, 49) pad 6 distance 37mm 1.4in +2.3= 3.76in wire 4.00in  
 wire N114 ( 66, 65) pad 7 distance 38mm 1.5in +2.3= 3.80in wire 4.00in  
 wire Q135 ( 66, 10) pad 8 distance 44mm 1.7in +2.3= 4.04in wire 4.50in  
 wire O125 ( 69, 49) pad 9 distance 48mm 1.9in +2.3= 4.21in wire 4.50in  
 wire P124 ( 78, 35) pad 10 distance 33mm 1.3in +2.3= 3.63in wire 3.75in  
 wire N113 ( 83, 66) pad 11 distance 37mm 1.5in +2.3= 3.79in wire 4.00in  
 wire Q134 ( 82, 10) pad 12 distance 43mm 1.7in +2.3= 4.00in wire 4.00in  
 wire O124 ( 85, 49) pad 13 distance 47mm 1.9in +2.3= 4.19in wire 4.50in  
 wire P123 ( 94, 36) pad 14 distance 33mm 1.3in +2.3= 3.63in wire 3.75in  
 wire M112 ( 90, 80) pad 15 distance 33mm 1.3in +2.3= 3.63in wire 3.75in  
 wire O123 (101, 50) pad 16 distance 36mm 1.4in +2.3= 3.74in wire 3.75in  
 wire N112 (100, 67) pad 17 distance 37mm 1.5in +2.3= 3.77in wire 4.00in  
 wire P122 (111, 37) pad 18 distance 34mm 1.4in +2.3= 3.68in wire 3.75in  
 wire M111 (106, 81) pad 19 distance 33mm 1.3in +2.3= 3.64in wire 3.75in  
 wire O122 (117, 52) pad 20 distance 38mm 1.5in +2.3= 3.80in wire 4.00in  
 wire N111 (116, 69) pad 21 distance 37mm 1.4in +2.3= 3.77in wire 4.00in  
 wire O121 (133, 55) pad 22 distance 42mm 1.7in +2.3= 3.98in wire 4.00in  
 wire N110 (132, 72) pad 23 distance 40mm 1.6in +2.3= 3.90in wire 4.00in

Longest wire O128 at 113.3mm 4.46in Mean dist 98.0mm 3.86in

8 3.75-inch wires 11 4-inch wires 5 4.5-inch wires 0 5-inch wires 0 longer wires

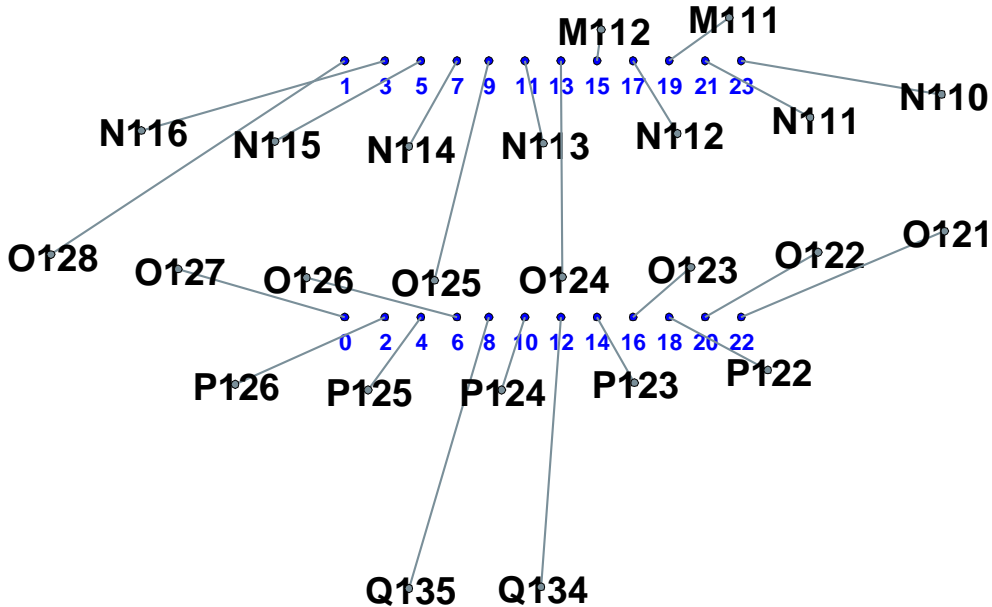

## E17

wire O135 ( 31, 54) pad 0 distance 43mm 1.7in +2.3= 4.01in wire 4.50in  
 wire O1 ( 16, 57) pad 1 distance 56mm 2.2in +2.3= 4.51in wire 5.00in  
 wire O134 ( 47, 52) pad 2 distance 38mm 1.5in +2.3= 3.81in wire 4.00in  
 wire N123 ( 32, 71) pad 3 distance 44mm 1.7in +2.3= 4.05in wire 4.50in  
 wire P133 ( 54, 38) pad 4 distance 34mm 1.4in +2.3= 3.68in wire 3.75in  
 wire N122 ( 49, 69) pad 5 distance 39mm 1.5in +2.3= 3.84in wire 4.00in  
 wire O133 ( 63, 51) pad 6 distance 34mm 1.3in +2.3= 3.65in wire 3.75in  
 wire N121 ( 66, 68) pad 7 distance 37mm 1.4in +2.3= 3.76in wire 4.00in  
 wire Q143 ( 69, 12) pad 8 distance 42mm 1.6in +2.3= 3.97in wire 4.00in  
 wire M120 ( 74, 81) pad 9 distance 33mm 1.3in +2.3= 3.62in wire 3.75in  
 wire P132 ( 71, 37) pad 10 distance 34mm 1.3in +2.3= 3.67in wire 3.75in  
 wire O132 ( 79, 50) pad 11 distance 46mm 1.8in +2.3= 4.15in wire 4.50in  
 wire Q142 ( 85, 12) pad 12 distance 41mm 1.6in +2.3= 3.95in wire 4.00in  
 wire N120 ( 82, 67) pad 13 distance 37mm 1.4in +2.3= 3.76in wire 4.00in  
 wire P131 ( 88, 37) pad 14 distance 33mm 1.3in +2.3= 3.63in wire 3.75in  
 wire M119 ( 90, 81) pad 15 distance 33mm 1.3in +2.3= 3.62in wire 3.75in  
 wire O131 ( 95, 51) pad 16 distance 36mm 1.4in +2.3= 3.73in wire 3.75in  
 wire N119 ( 99, 68) pad 17 distance 36mm 1.4in +2.3= 3.76in wire 4.00in  
 wire P130 (104, 38) pad 18 distance 33mm 1.3in +2.3= 3.63in wire 3.75in  
 wire M118 (106, 82) pad 19 distance 33mm 1.3in +2.3= 3.64in wire 3.75in  
 wire O130 (111, 52) pad 20 distance 36mm 1.4in +2.3= 3.75in wire 3.75in  
 wire N118 (116, 69) pad 21 distance 36mm 1.4in +2.3= 3.76in wire 4.00in  
 wire P129 (121, 39) pad 22 distance 34mm 1.3in +2.3= 3.67in wire 3.75in  
 wire O129 (127, 54) pad 23 distance 46mm 1.8in +2.3= 4.14in wire 4.50in

Longest wire O1 at 114.5mm 4.51in Mean dist 97.1mm 3.82in

11 3.75-inch wires 8 4-inch wires 4 4.5-inch wires 1 5-inch wires 0 longer wires

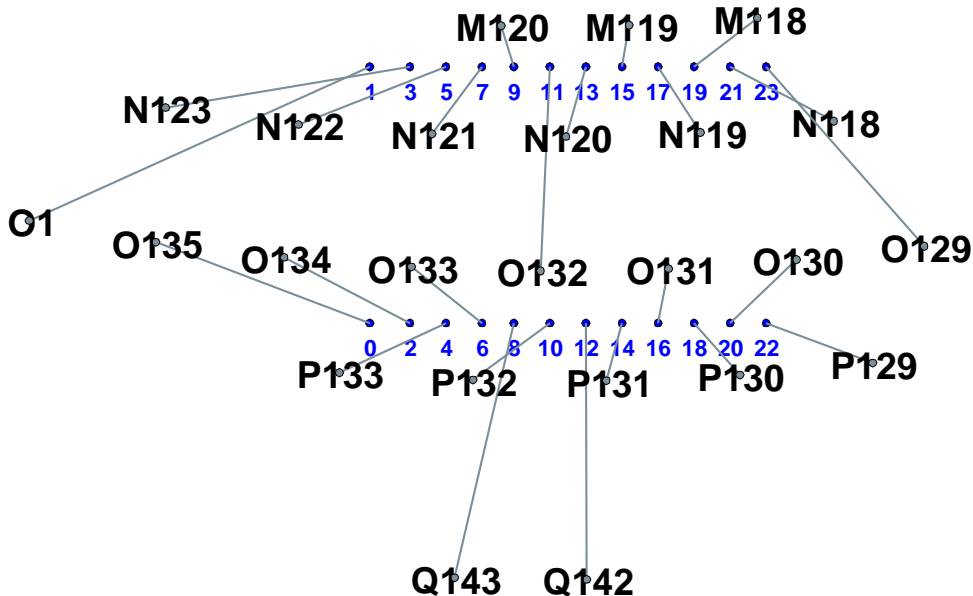

# F1

wire S4 ( 15, 43) pad 0 distance 51mm 2.0in +2.3= 4.34in wire 4.50in  
 wire R4 ( 14, 60) pad 1 distance 55mm 2.2in +2.3= 4.49in wire 4.50in  
 wire S3 ( 31, 40) pad 2 distance 43mm 1.7in +2.3= 4.03in wire 4.50in  
 wire Q3 ( 25, 72) pad 3 distance 48mm 1.9in +2.3= 4.22in wire 4.50in  
 wire S2 ( 47, 38) pad 4 distance 37mm 1.5in +2.3= 3.78in wire 4.00in  
 wire R3 ( 31, 57) pad 5 distance 53mm 2.1in +2.3= 4.41in wire 4.50in  
 wire R2 ( 48, 54) pad 6 distance 40mm 1.6in +2.3= 3.88in wire 4.00in  
 wire Q2 ( 42, 70) pad 7 distance 45mm 1.8in +2.3= 4.09in wire 4.50in  
 wire S1 ( 64, 37) pad 8 distance 35mm 1.4in +2.3= 3.70in wire 3.75in  
 wire Q1 ( 58, 68) pad 9 distance 40mm 1.6in +2.3= 3.91in wire 4.00in  
 wire R1 ( 65, 53) pad 10 distance 39mm 1.6in +2.3= 3.88in wire 4.00in  
 wire P135 ( 73, 91) pad 11 distance 35mm 1.4in +2.3= 3.69in wire 3.75in  
 wire S158 ( 80, 36) pad 12 distance 33mm 1.3in +2.3= 3.64in wire 3.75in  
 wire Q146 ( 74, 66) pad 13 distance 39mm 1.5in +2.3= 3.84in wire 4.00in  
 wire R146 ( 82, 52) pad 14 distance 37mm 1.5in +2.3= 3.79in wire 4.00in  
 wire P134 ( 90, 91) pad 15 distance 34mm 1.3in +2.3= 3.66in wire 3.75in  
 wire S157 ( 96, 36) pad 16 distance 33mm 1.3in +2.3= 3.62in wire 3.75in  
 wire Q145 ( 91, 66) pad 17 distance 38mm 1.5in +2.3= 3.80in wire 4.00in  
 wire R145 ( 99, 52) pad 18 distance 36mm 1.4in +2.3= 3.73in wire 3.75in  
 wire Q144 (107, 66) pad 19 distance 38mm 1.5in +2.3= 3.80in wire 4.00in  
 wire S156 (113, 36) pad 20 distance 34mm 1.3in +2.3= 3.65in wire 3.75in  
 wire R144 (116, 52) pad 21 distance 45mm 1.8in +2.3= 4.11in wire 4.50in  
 wire S155 (129, 37) pad 22 distance 37mm 1.5in +2.3= 3.79in wire 4.00in  
 wire R143 (133, 54) pad 23 distance 48mm 1.9in +2.3= 4.23in wire 4.50in

Longest wire R4 at 114.0mm 4.49in Mean dist 99.6mm 3.92in

7 3.75-inch wires 9 4-inch wires 8 4.5-inch wires 0 5-inch wires 0 longer wires

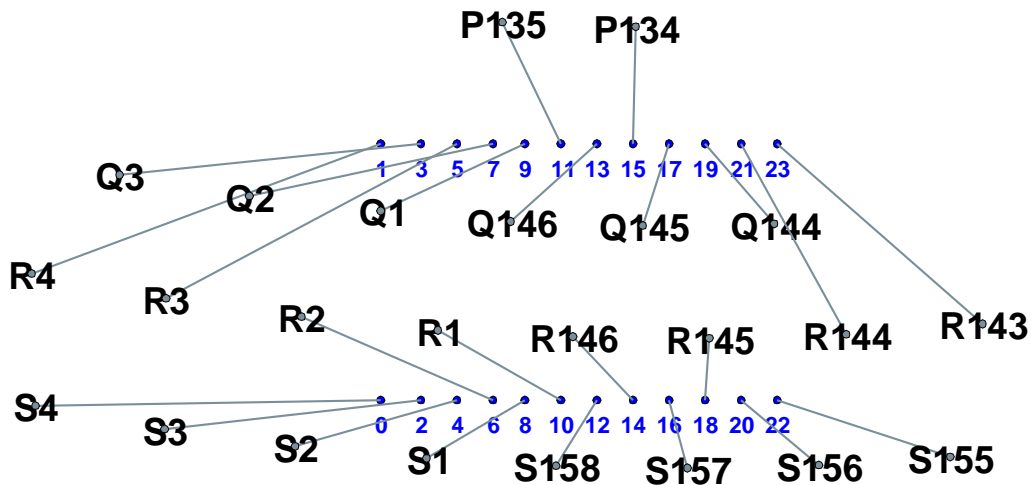

## F2

wire S12 ( 25, 41) pad 0 distance 44mm 1.7in +2.3= 4.04in wire 4.50in  
 wire R12 ( 14, 60) pad 1 distance 55mm 2.2in +2.3= 4.49in wire 4.50in  
 wire S11 ( 42, 39) pad 2 distance 37mm 1.5in +2.3= 3.79in wire 4.00in  
 wire Q11 ( 25, 72) pad 3 distance 48mm 1.9in +2.3= 4.22in wire 4.50in  
 wire R10 ( 48, 54) pad 4 distance 40mm 1.6in +2.3= 3.90in wire 4.00in  
 wire R11 ( 31, 57) pad 5 distance 53mm 2.1in +2.3= 4.41in wire 4.50in  
 wire R9 ( 65, 53) pad 6 distance 34mm 1.3in +2.3= 3.64in wire 3.75in  
 wire Q10 ( 42, 70) pad 7 distance 45mm 1.8in +2.3= 4.09in wire 4.50in  
 wire S10 ( 58, 37) pad 8 distance 37mm 1.5in +2.3= 3.78in wire 4.00in  
 wire Q9 ( 58, 68) pad 9 distance 40mm 1.6in +2.3= 3.91in wire 4.00in  
 wire S9 ( 74, 36) pad 10 distance 34mm 1.3in +2.3= 3.64in wire 3.75in  
 wire Q8 ( 74, 66) pad 11 distance 37mm 1.5in +2.3= 3.80in wire 4.00in  
 wire R8 ( 82, 52) pad 12 distance 36mm 1.4in +2.3= 3.75in wire 4.00in  
 wire S8 ( 91, 35) pad 14 distance 33mm 1.3in +2.3= 3.62in wire 3.75in  
 wire Q7 ( 91, 66) pad 15 distance 37mm 1.5in +2.3= 3.79in wire 4.00in  
 wire R7 ( 99, 52) pad 16 distance 36mm 1.4in +2.3= 3.75in wire 3.75in  
 wire Q6 (107, 66) pad 17 distance 39mm 1.5in +2.3= 3.85in wire 4.00in  
 wire S7 (107, 36) pad 18 distance 34mm 1.3in +2.3= 3.65in wire 3.75in  
 wire R6 (116, 52) pad 19 distance 48mm 1.9in +2.3= 4.20in wire 4.50in  
 wire S6 (124, 36) pad 20 distance 37mm 1.5in +2.3= 3.80in wire 4.00in  
 wire Q5 (124, 67) pad 21 distance 40mm 1.6in +2.3= 3.90in wire 4.00in  
 wire S5 (140, 38) pad 22 distance 43mm 1.7in +2.3= 4.03in wire 4.50in  
 wire R5 (133, 53) pad 23 distance 49mm 1.9in +2.3= 4.24in wire 4.50in

Longest wire R12 at 114.1mm 4.49in Mean dist 99.7mm 3.93in

5 3.75-inch wires 10 4-inch wires 8 4.5-inch wires 0 5-inch wires 0 longer wires

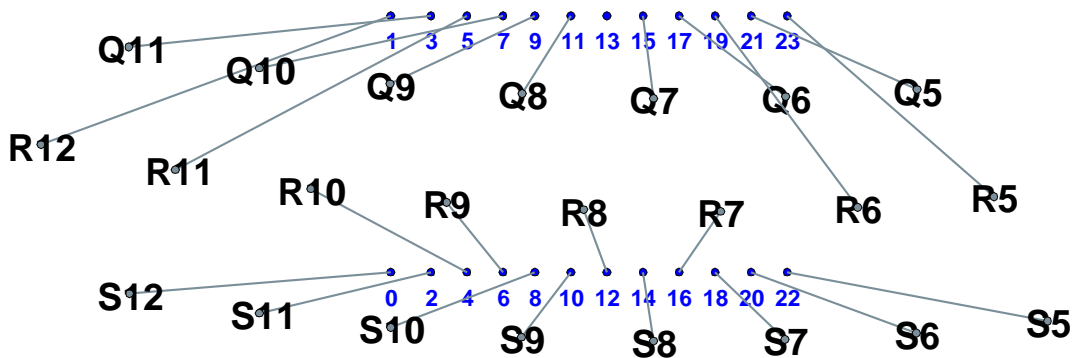

### F3

wire R19 ( 31, 57) pad 0 distance 44mm 1.7in +2.3= 4.05in wire 4.50in  
 wire Q19 ( 25, 72) pad 1 distance 44mm 1.7in +2.3= 4.05in wire 4.50in  
 wire S20 ( 36, 40) pad 2 distance 40mm 1.6in +2.3= 3.91in wire 4.00in  
 wire Q18 ( 42, 70) pad 3 distance 39mm 1.6in +2.3= 3.87in wire 4.00in  
 wire S19 ( 52, 38) pad 4 distance 35mm 1.4in +2.3= 3.70in wire 3.75in  
 wire R18 ( 48, 54) pad 5 distance 46mm 1.8in +2.3= 4.13in wire 4.50in  
 wire R17 ( 65, 53) pad 6 distance 34mm 1.3in +2.3= 3.64in wire 3.75in  
 wire P16 ( 53, 93) pad 7 distance 38mm 1.5in +2.3= 3.82in wire 4.00in  
 wire T18 ( 59, 23) pad 8 distance 39mm 1.5in +2.3= 3.87in wire 4.00in  
 wire Q17 ( 58, 68) pad 9 distance 40mm 1.6in +2.3= 3.91in wire 4.00in  
 wire S18 ( 69, 36) pad 10 distance 35mm 1.4in +2.3= 3.70in wire 3.75in  
 wire P15 ( 70, 91) pad 11 distance 36mm 1.4in +2.3= 3.72in wire 3.75in  
 wire T17 ( 76, 22) pad 12 distance 37mm 1.5in +2.3= 3.80in wire 4.00in  
 wire Q16 ( 74, 66) pad 13 distance 39mm 1.5in +2.3= 3.84in wire 4.00in  
 wire S17 ( 85, 36) pad 14 distance 34mm 1.3in +2.3= 3.64in wire 3.75in  
 wire R16 ( 82, 52) pad 15 distance 46mm 1.8in +2.3= 4.14in wire 4.50in  
 wire S16 (102, 35) pad 16 distance 33mm 1.3in +2.3= 3.64in wire 3.75in  
 wire Q15 ( 91, 66) pad 17 distance 38mm 1.5in +2.3= 3.80in wire 4.00in  
 wire R15 ( 99, 52) pad 18 distance 36mm 1.4in +2.3= 3.73in wire 3.75in  
 wire Q14 (107, 66) pad 19 distance 38mm 1.5in +2.3= 3.81in wire 4.00in  
 wire R14 (116, 52) pad 20 distance 37mm 1.5in +2.3= 3.79in wire 4.00in  
 wire Q13 (124, 67) pad 21 distance 40mm 1.6in +2.3= 3.90in wire 4.00in  
 wire R13 (133, 53) pad 22 distance 42mm 1.6in +2.3= 3.97in wire 4.00in  
 wire Q12 (140, 68) pad 23 distance 45mm 1.8in +2.3= 4.11in wire 4.50in

Longest wire R16 at 105.2mm 4.14in Mean dist 98.0mm 3.86in

7 3.75-inch wires 12 4-inch wires 5 4.5-inch wires 0 5-inch wires 0 longer wires

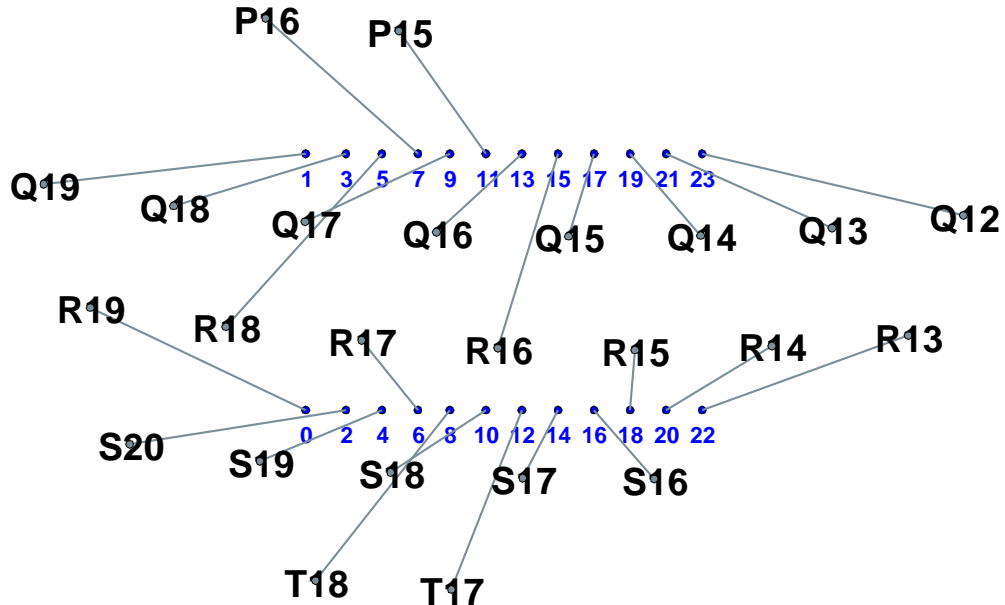

## F4

wire R26 ( 31, 57) pad 0 distance 44mm 1.7in +2.3= 4.05in wire 4.50in  
 wire Q26 ( 25, 72) pad 1 distance 44mm 1.7in +2.3= 4.05in wire 4.50in  
 wire S28 ( 29, 41) pad 2 distance 45mm 1.8in +2.3= 4.08in wire 4.50in  
 wire Q25 ( 42, 70) pad 3 distance 39mm 1.5in +2.3= 3.87in wire 4.00in  
 wire S27 ( 46, 38) pad 4 distance 38mm 1.5in +2.3= 3.81in wire 4.00in  
 wire R25 ( 48, 54) pad 5 distance 46mm 1.8in +2.3= 4.13in wire 4.50in  
 wire R24 ( 65, 53) pad 6 distance 34mm 1.3in +2.3= 3.64in wire 3.75in  
 wire Q24 ( 58, 68) pad 7 distance 38mm 1.5in +2.3= 3.82in wire 4.00in  
 wire T26 ( 52, 24) pad 8 distance 42mm 1.7in +2.3= 3.99in wire 4.00in  
 wire Q23 ( 74, 66) pad 9 distance 37mm 1.5in +2.3= 3.78in wire 4.00in  
 wire S26 ( 62, 37) pad 10 distance 38mm 1.5in +2.3= 3.81in wire 4.00in  
 wire R23 ( 82, 52) pad 11 distance 45mm 1.8in +2.3= 4.11in wire 4.50in  
 wire T25 ( 69, 22) pad 12 distance 40mm 1.6in +2.3= 3.88in wire 4.00in  
 wire S25 ( 78, 36) pad 14 distance 35mm 1.4in +2.3= 3.72in wire 3.75in  
 wire Q22 ( 91, 66) pad 15 distance 37mm 1.5in +2.3= 3.79in wire 4.00in  
 wire S24 ( 95, 36) pad 16 distance 33mm 1.3in +2.3= 3.62in wire 3.75in  
 wire R22 ( 99, 52) pad 18 distance 36mm 1.4in +2.3= 3.73in wire 3.75in  
 wire Q21 (107, 66) pad 19 distance 38mm 1.5in +2.3= 3.80in wire 4.00in  
 wire S23 (111, 36) pad 20 distance 33mm 1.3in +2.3= 3.64in wire 3.75in  
 wire Q20 (124, 67) pad 21 distance 40mm 1.6in +2.3= 3.90in wire 4.00in  
 wire R21 (116, 52) pad 22 distance 36mm 1.4in +2.3= 3.73in wire 3.75in  
 wire R20 (133, 54) pad 23 distance 48mm 1.9in +2.3= 4.23in wire 4.50in

Longest wire R20 at 107.5mm 4.23in Mean dist 98.3mm 3.87in

6 3.75-inch wires 10 4-inch wires 6 4.5-inch wires 0 5-inch wires 0 longer wires

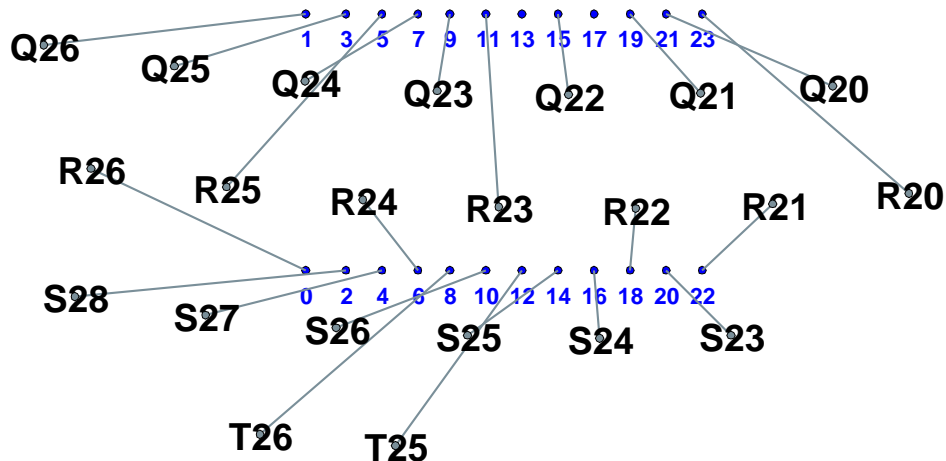

## F5

wire R34 ( 31, 57) pad 0 distance 44mm 1.7in +2.3= 4.05in wire 4.50in  
 wire Q34 ( 25, 72) pad 1 distance 44mm 1.7in +2.3= 4.06in wire 4.50in  
 wire R33 ( 48, 54) pad 2 distance 38mm 1.5in +2.3= 3.84in wire 4.00in  
 wire Q33 ( 42, 70) pad 3 distance 39mm 1.6in +2.3= 3.87in wire 4.00in  
 wire S35 ( 56, 37) pad 4 distance 34mm 1.3in +2.3= 3.66in wire 3.75in  
 wire Q32 ( 58, 68) pad 5 distance 37mm 1.4in +2.3= 3.76in wire 4.00in  
 wire R32 ( 65, 53) pad 6 distance 34mm 1.3in +2.3= 3.65in wire 3.75in  
 wire T34 ( 63, 22) pad 8 distance 38mm 1.5in +2.3= 3.81in wire 4.00in  
 wire Q31 ( 74, 66) pad 9 distance 37mm 1.5in +2.3= 3.78in wire 4.00in  
 wire S34 ( 73, 36) pad 10 distance 34mm 1.3in +2.3= 3.65in wire 3.75in  
 wire R31 ( 82, 52) pad 11 distance 45mm 1.8in +2.3= 4.11in wire 4.50in  
 wire T33 ( 80, 22) pad 12 distance 37mm 1.4in +2.3= 3.77in wire 4.00in  
 wire S33 ( 89, 36) pad 14 distance 33mm 1.3in +2.3= 3.63in wire 3.75in  
 wire Q30 ( 91, 66) pad 15 distance 37mm 1.5in +2.3= 3.79in wire 4.00in  
 wire R30 ( 99, 52) pad 16 distance 36mm 1.4in +2.3= 3.75in wire 3.75in  
 wire Q29 (107, 66) pad 17 distance 39mm 1.5in +2.3= 3.85in wire 4.00in  
 wire S32 (105, 36) pad 18 distance 33mm 1.3in +2.3= 3.64in wire 3.75in  
 wire R29 (116, 52) pad 19 distance 48mm 1.9in +2.3= 4.20in wire 4.50in  
 wire S31 (122, 36) pad 20 distance 37mm 1.4in +2.3= 3.76in wire 4.00in  
 wire Q28 (124, 67) pad 21 distance 40mm 1.6in +2.3= 3.89in wire 4.00in  
 wire R28 (133, 54) pad 22 distance 42mm 1.6in +2.3= 3.97in wire 4.00in  
 wire Q27 (140, 69) pad 23 distance 45mm 1.8in +2.3= 4.11in wire 4.50in

Longest wire R29 at 106.6mm 4.20in Mean dist 97.7mm 3.85in

6 3.75-inch wires 11 4-inch wires 5 4.5-inch wires 0 5-inch wires 0 longer wires

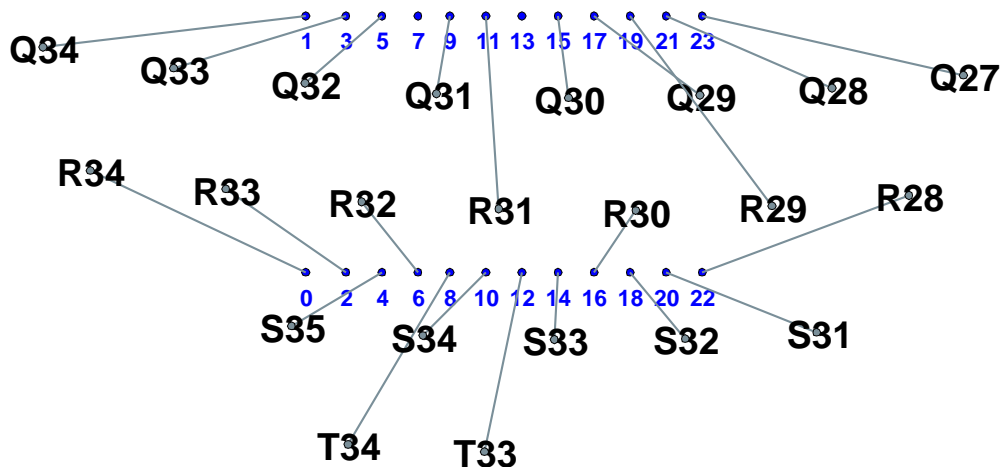



## F6

wire R42 ( 31, 57) pad 0 distance 44mm 1.7in +2.3= 4.05in wire 4.50in  
 wire Q42 ( 25, 72) pad 1 distance 44mm 1.7in +2.3= 4.06in wire 4.50in  
 wire R41 ( 48, 54) pad 2 distance 38mm 1.5in +2.3= 3.84in wire 4.00in  
 wire Q41 ( 42, 70) pad 3 distance 39mm 1.6in +2.3= 3.87in wire 4.00in  
 wire S43 ( 67, 36) pad 4 distance 33mm 1.3in +2.3= 3.63in wire 3.75in  
 wire Q40 ( 58, 68) pad 5 distance 37mm 1.4in +2.3= 3.76in wire 4.00in  
 wire R40 ( 65, 53) pad 6 distance 34mm 1.3in +2.3= 3.64in wire 3.75in  
 wire S42 ( 83, 36) pad 8 distance 34mm 1.3in +2.3= 3.66in wire 3.75in  
 wire Q39 ( 74, 66) pad 9 distance 37mm 1.5in +2.3= 3.78in wire 4.00in  
 wire T41 ( 91, 21) pad 10 distance 38mm 1.5in +2.3= 3.83in wire 4.00in  
 wire R39 ( 82, 52) pad 11 distance 45mm 1.8in +2.3= 4.11in wire 4.50in  
 wire R38 ( 99, 52) pad 12 distance 39mm 1.5in +2.3= 3.85in wire 4.00in  
 wire Q38 ( 91, 66) pad 13 distance 38mm 1.5in +2.3= 3.81in wire 4.00in  
 wire S41 (100, 35) pad 14 distance 34mm 1.3in +2.3= 3.67in wire 3.75in  
 wire Q37 (107, 66) pad 15 distance 41mm 1.6in +2.3= 3.94in wire 4.00in  
 wire T40 (108, 22) pad 16 distance 38mm 1.5in +2.3= 3.84in wire 4.00in  
 wire P34 (107, 91) pad 17 distance 36mm 1.4in +2.3= 3.73in wire 3.75in  
 wire S40 (116, 36) pad 18 distance 36mm 1.4in +2.3= 3.75in wire 4.00in  
 wire P33 (124, 92) pad 19 distance 41mm 1.6in +2.3= 3.94in wire 4.00in  
 wire R37 (116, 52) pad 20 distance 37mm 1.5in +2.3= 3.79in wire 4.00in  
 wire Q36 (124, 67) pad 21 distance 40mm 1.6in +2.3= 3.90in wire 4.00in  
 wire R36 (133, 53) pad 22 distance 42mm 1.6in +2.3= 3.97in wire 4.00in  
 wire Q35 (140, 68) pad 23 distance 45mm 1.8in +2.3= 4.11in wire 4.50in

Longest wire R39 at 104.5mm 4.11in Mean dist 97.8mm 3.85in

5 3.75-inch wires 14 4-inch wires 4 4.5-inch wires 0 5-inch wires 0 longer wires

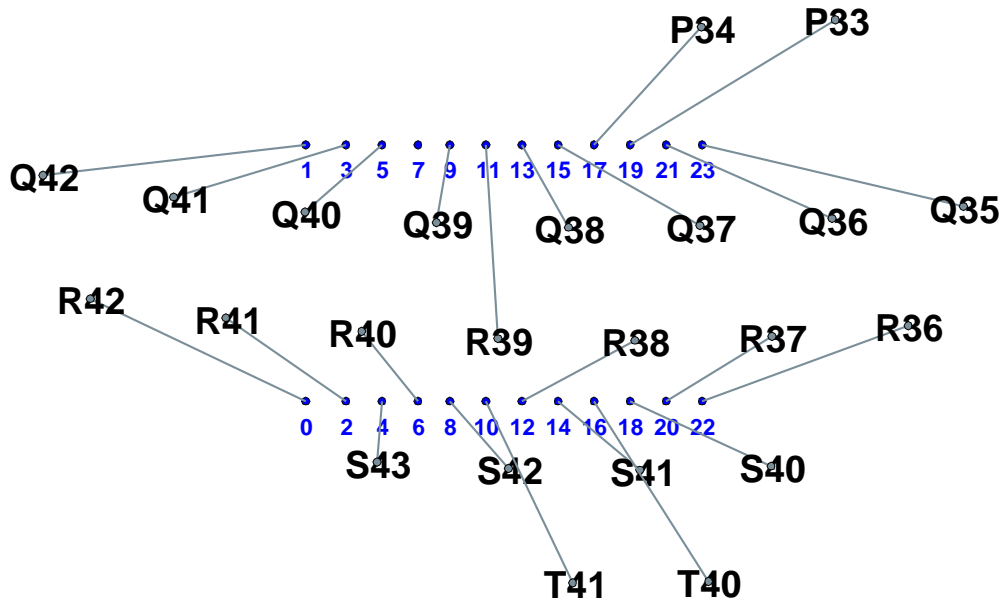

## F7

wire R49 ( 31, 57) pad 0 distance 44mm 1.7in +2.3= 4.05in wire 4.50in  
 wire Q49 ( 25, 72) pad 1 distance 44mm 1.7in +2.3= 4.05in wire 4.50in  
 wire S52 ( 44, 39) pad 2 distance 36mm 1.4in +2.3= 3.76in wire 4.00in  
 wire Q48 ( 42, 70) pad 3 distance 39mm 1.5in +2.3= 3.87in wire 4.00in  
 wire S51 ( 60, 37) pad 4 distance 33mm 1.3in +2.3= 3.63in wire 3.75in  
 wire R48 ( 48, 54) pad 5 distance 46mm 1.8in +2.3= 4.13in wire 4.50in  
 wire R47 ( 65, 53) pad 6 distance 34mm 1.3in +2.3= 3.65in wire 3.75in  
 wire Q47 ( 58, 68) pad 7 distance 38mm 1.5in +2.3= 3.82in wire 4.00in  
 wire S50 ( 76, 36) pad 8 distance 33mm 1.3in +2.3= 3.62in wire 3.75in  
 wire Q46 ( 74, 66) pad 9 distance 37mm 1.5in +2.3= 3.78in wire 4.00in  
 wire R46 ( 82, 52) pad 10 distance 36mm 1.4in +2.3= 3.75in wire 4.00in  
 wire S49 ( 93, 36) pad 12 distance 34mm 1.3in +2.3= 3.66in wire 3.75in  
 wire Q45 ( 91, 66) pad 13 distance 38mm 1.5in +2.3= 3.80in wire 4.00in  
 wire R45 ( 99, 52) pad 14 distance 37mm 1.5in +2.3= 3.78in wire 4.00in  
 wire P41 ( 99, 91) pad 15 distance 35mm 1.4in +2.3= 3.70in wire 3.75in  
 wire T48 (101, 22) pad 16 distance 37mm 1.4in +2.3= 3.77in wire 4.00in  
 wire Q44 (107, 66) pad 17 distance 39mm 1.5in +2.3= 3.85in wire 4.00in  
 wire S48 (109, 36) pad 18 distance 34mm 1.3in +2.3= 3.67in wire 3.75in  
 wire P40 (115, 91) pad 19 distance 37mm 1.5in +2.3= 3.78in wire 4.00in  
 wire R44 (116, 52) pad 20 distance 37mm 1.5in +2.3= 3.80in wire 4.00in  
 wire Q43 (124, 67) pad 21 distance 40mm 1.6in +2.3= 3.89in wire 4.00in  
 wire S47 (126, 37) pad 22 distance 36mm 1.4in +2.3= 3.73in wire 3.75in  
 wire R43 (133, 54) pad 23 distance 48mm 1.9in +2.3= 4.23in wire 4.50in

Longest wire R43 at 107.4mm 4.23in Mean dist 96.9mm 3.82in

7 3.75-inch wires 12 4-inch wires 4 4.5-inch wires 0 5-inch wires 0 longer wires

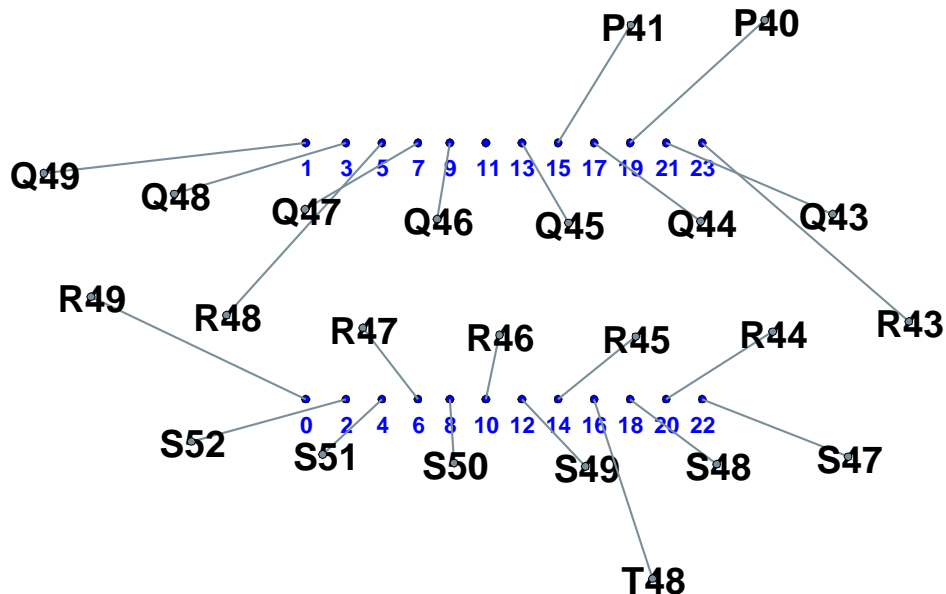

## F8

wire S61 ( 38, 39) pad 0 distance 37mm 1.4in +2.3= 3.77in wire 4.00in  
 wire Q57 ( 25, 72) pad 1 distance 44mm 1.7in +2.3= 4.05in wire 4.50in  
 wire R56 ( 48, 54) pad 2 distance 38mm 1.5in +2.3= 3.84in wire 4.00in  
 wire R57 ( 31, 57) pad 3 distance 50mm 2.0in +2.3= 4.29in wire 4.50in  
 wire S60 ( 54, 38) pad 4 distance 34mm 1.4in +2.3= 3.67in wire 3.75in  
 wire Q56 ( 42, 70) pad 5 distance 42mm 1.6in +2.3= 3.97in wire 4.00in  
 wire R55 ( 65, 53) pad 6 distance 34mm 1.3in +2.3= 3.64in wire 3.75in  
 wire Q55 ( 58, 68) pad 7 distance 38mm 1.5in +2.3= 3.82in wire 4.00in  
 wire S59 ( 71, 36) pad 8 distance 33mm 1.3in +2.3= 3.63in wire 3.75in  
 wire Q54 ( 74, 66) pad 9 distance 37mm 1.5in +2.3= 3.78in wire 4.00in  
 wire R54 ( 82, 52) pad 10 distance 36mm 1.4in +2.3= 3.75in wire 3.75in  
 wire P49 ( 89, 91) pad 11 distance 35mm 1.4in +2.3= 3.70in wire 3.75in  
 wire S58 ( 87, 36) pad 12 distance 33mm 1.3in +2.3= 3.63in wire 3.75in  
 wire Q53 ( 91, 66) pad 13 distance 38mm 1.5in +2.3= 3.80in wire 4.00in  
 wire R53 ( 99, 52) pad 14 distance 37mm 1.5in +2.3= 3.78in wire 4.00in  
 wire P48 ( 105, 91) pad 15 distance 37mm 1.5in +2.3= 3.79in wire 4.00in  
 wire S57 ( 104, 36) pad 16 distance 34mm 1.3in +2.3= 3.66in wire 3.75in  
 wire Q52 ( 107, 66) pad 17 distance 39mm 1.5in +2.3= 3.85in wire 4.00in  
 wire R52 ( 116, 52) pad 18 distance 39mm 1.5in +2.3= 3.86in wire 4.00in  
 wire Q51 ( 124, 67) pad 19 distance 43mm 1.7in +2.3= 4.02in wire 4.50in  
 wire S56 ( 120, 36) pad 20 distance 36mm 1.4in +2.3= 3.74in wire 3.75in  
 wire R51 ( 133, 54) pad 21 distance 51mm 2.0in +2.3= 4.32in wire 4.50in  
 wire S55 ( 136, 38) pad 22 distance 41mm 1.6in +2.3= 3.94in wire 4.00in  
 wire Q50 ( 140, 69) pad 23 distance 45mm 1.8in +2.3= 4.11in wire 4.50in

Longest wire R51 at 109.8mm 4.32in Mean dist 97.8mm 3.85in

8 3.75-inch wires 11 4-inch wires 5 4.5-inch wires 0 5-inch wires 0 longer wires

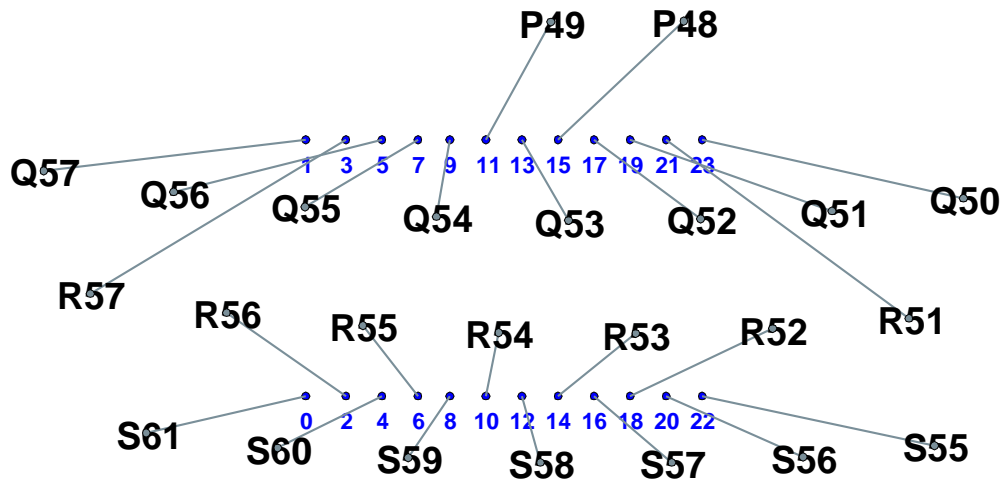

## F9

wire R64 ( 31, 57) pad 0 distance 44mm 1.7in +2.3= 4.05in wire 4.50in  
 wire R65 ( 14, 60) pad 1 distance 55mm 2.2in +2.3= 4.49in wire 4.50in  
 wire S69 ( 31, 40) pad 2 distance 43mm 1.7in +2.3= 4.03in wire 4.50in  
 wire Q63 ( 42, 70) pad 3 distance 39mm 1.6in +2.3= 3.87in wire 4.00in  
 wire S68 ( 47, 38) pad 4 distance 37mm 1.5in +2.3= 3.78in wire 4.00in  
 wire Q62 ( 58, 68) pad 5 distance 37mm 1.4in +2.3= 3.76in wire 4.00in  
 wire R63 ( 48, 54) pad 6 distance 40mm 1.6in +2.3= 3.88in wire 4.00in  
 wire P57 ( 63, 92) pad 7 distance 35mm 1.4in +2.3= 3.69in wire 3.75in  
 wire S67 ( 64, 37) pad 8 distance 35mm 1.4in +2.3= 3.69in wire 3.75in  
 wire O57 ( 72,105) pad 9 distance 40mm 1.6in +2.3= 3.89in wire 4.00in  
 wire R62 ( 65, 53) pad 10 distance 40mm 1.6in +2.3= 3.88in wire 4.00in  
 wire Q61 ( 74, 66) pad 11 distance 37mm 1.5in +2.3= 3.80in wire 4.00in  
 wire S66 ( 80, 36) pad 12 distance 33mm 1.3in +2.3= 3.64in wire 3.75in  
 wire P56 ( 80, 91) pad 13 distance 34mm 1.4in +2.3= 3.67in wire 3.75in  
 wire R61 ( 82, 52) pad 14 distance 37mm 1.5in +2.3= 3.79in wire 4.00in  
 wire Q60 ( 91, 66) pad 15 distance 37mm 1.5in +2.3= 3.79in wire 4.00in  
 wire S65 ( 97, 35) pad 16 distance 33mm 1.3in +2.3= 3.62in wire 3.75in  
 wire R60 ( 99, 52) pad 17 distance 46mm 1.8in +2.3= 4.12in wire 4.50in  
 wire S64 (113, 36) pad 18 distance 35mm 1.4in +2.3= 3.71in wire 3.75in  
 wire Q59 (107, 66) pad 19 distance 38mm 1.5in +2.3= 3.81in wire 4.00in  
 wire R59 (116, 52) pad 20 distance 37mm 1.5in +2.3= 3.79in wire 4.00in  
 wire Q58 (124, 67) pad 21 distance 40mm 1.6in +2.3= 3.90in wire 4.00in  
 wire S63 (129, 37) pad 22 distance 37mm 1.5in +2.3= 3.79in wire 4.00in  
 wire R58 (133, 53) pad 23 distance 49mm 1.9in +2.3= 4.24in wire 4.50in

Longest wire R65 at 114.1mm 4.49in Mean dist 98.1mm 3.86in

6 3.75-inch wires 13 4-inch wires 5 4.5-inch wires 0 5-inch wires 0 longer wires

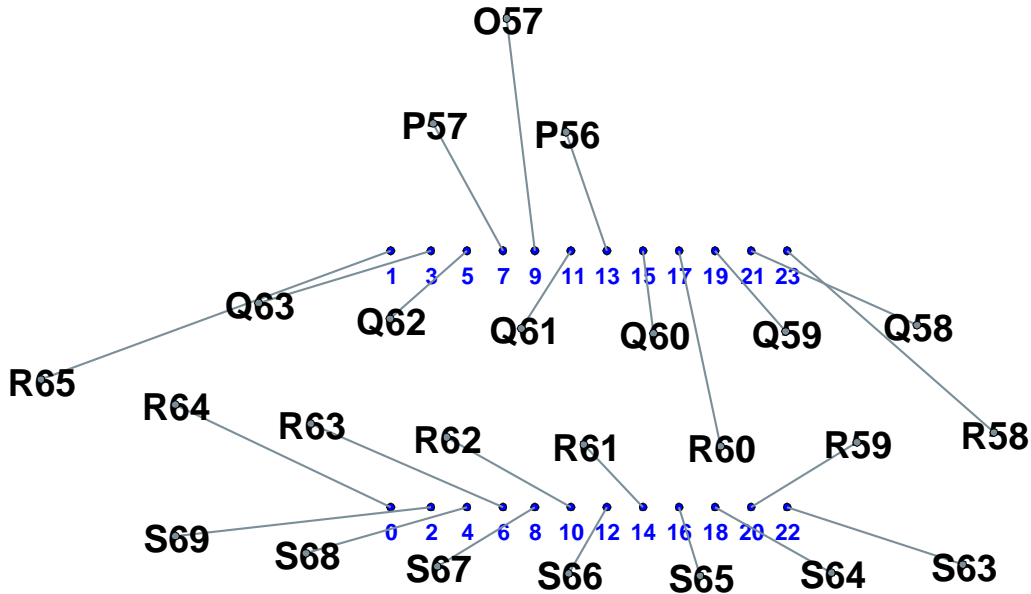

## F10

wire S78 ( 26, 41) pad 0 distance 44mm 1.7in +2.3= 4.04in wire 4.50in  
 wire Q72 ( 25, 72) pad 1 distance 44mm 1.7in +2.3= 4.06in wire 4.50in  
 wire S77 ( 42, 39) pad 2 distance 37mm 1.5in +2.3= 3.79in wire 4.00in  
 wire R72 ( 31, 57) pad 3 distance 50mm 2.0in +2.3= 4.30in wire 4.50in  
 wire R71 ( 48, 54) pad 4 distance 40mm 1.6in +2.3= 3.90in wire 4.00in  
 wire Q71 ( 42, 69) pad 5 distance 42mm 1.6in +2.3= 3.97in wire 4.00in  
 wire R70 ( 65, 53) pad 6 distance 34mm 1.3in +2.3= 3.65in wire 3.75in  
 wire Q70 ( 58, 68) pad 7 distance 38mm 1.5in +2.3= 3.82in wire 4.00in  
 wire S76 ( 58, 37) pad 8 distance 37mm 1.5in +2.3= 3.78in wire 4.00in  
 wire P64 ( 70, 91) pad 9 distance 34mm 1.4in +2.3= 3.68in wire 3.75in  
 wire S75 ( 74, 36) pad 10 distance 33mm 1.3in +2.3= 3.64in wire 3.75in  
 wire Q69 ( 74, 66) pad 11 distance 37mm 1.5in +2.3= 3.80in wire 4.00in  
 wire R69 ( 82, 52) pad 12 distance 36mm 1.4in +2.3= 3.75in wire 3.75in  
 wire P63 ( 86, 90) pad 13 distance 34mm 1.3in +2.3= 3.66in wire 3.75in  
 wire S74 ( 91, 35) pad 14 distance 33mm 1.3in +2.3= 3.62in wire 3.75in  
 wire Q68 ( 91, 66) pad 15 distance 37mm 1.5in +2.3= 3.79in wire 4.00in  
 wire R68 ( 99, 52) pad 16 distance 36mm 1.4in +2.3= 3.75in wire 3.75in  
 wire Q67 (107, 66) pad 17 distance 39mm 1.5in +2.3= 3.85in wire 4.00in  
 wire S73 (107, 36) pad 18 distance 34mm 1.3in +2.3= 3.65in wire 3.75in  
 wire R67 (116, 52) pad 19 distance 48mm 1.9in +2.3= 4.20in wire 4.50in  
 wire S72 (124, 36) pad 20 distance 38mm 1.5in +2.3= 3.80in wire 4.00in  
 wire Q66 (124, 67) pad 21 distance 40mm 1.6in +2.3= 3.90in wire 4.00in  
 wire S71 (140, 38) pad 22 distance 43mm 1.7in +2.3= 4.03in wire 4.50in  
 wire R66 (133, 53) pad 23 distance 49mm 1.9in +2.3= 4.24in wire 4.50in

Longest wire R72 at 109.1mm 4.30in Mean dist 98.1mm 3.86in

8 3.75-inch wires 10 4-inch wires 6 4.5-inch wires 0 5-inch wires 0 longer wires

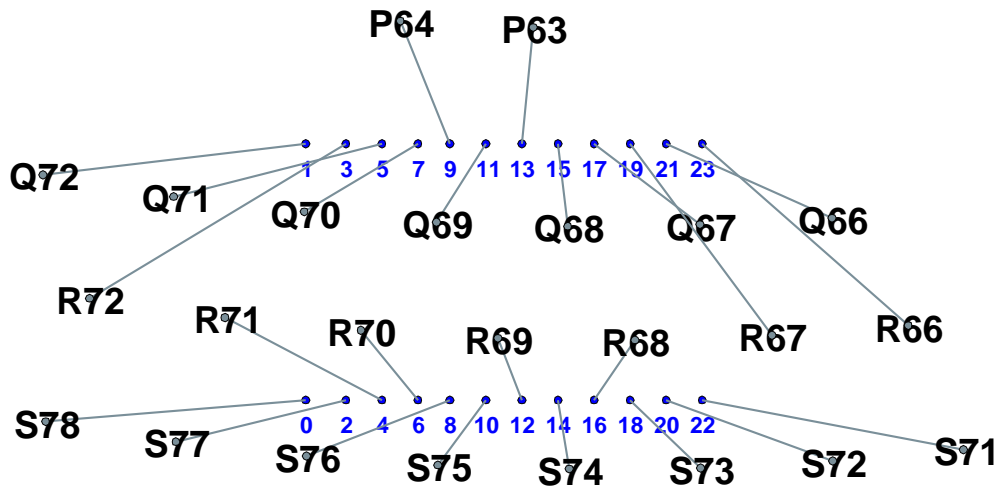

## F11

wire S86 ( 36, 40) pad 0 distance 38mm 1.5in +2.3= 3.80in wire 4.00in  
 wire R80 ( 31, 57) pad 1 distance 46mm 1.8in +2.3= 4.15in wire 4.50in  
 wire T85 ( 43, 25) pad 2 distance 39mm 1.5in +2.3= 3.87in wire 4.00in  
 wire Q79 ( 41, 70) pad 3 distance 39mm 1.6in +2.3= 3.88in wire 4.00in  
 wire S85 ( 52, 38) pad 4 distance 35mm 1.4in +2.3= 3.70in wire 3.75in  
 wire R79 ( 48, 54) pad 5 distance 46mm 1.8in +2.3= 4.13in wire 4.50in  
 wire R78 ( 65, 53) pad 6 distance 34mm 1.3in +2.3= 3.65in wire 3.75in  
 wire Q78 ( 58, 68) pad 7 distance 38mm 1.5in +2.3= 3.82in wire 4.00in  
 wire T84 ( 60, 23) pad 8 distance 39mm 1.5in +2.3= 3.86in wire 4.00in  
 wire P72 ( 60, 92) pad 9 distance 38mm 1.5in +2.3= 3.80in wire 4.00in  
 wire S84 ( 69, 36) pad 10 distance 35mm 1.4in +2.3= 3.69in wire 3.75in  
 wire Q77 ( 74, 66) pad 11 distance 37mm 1.5in +2.3= 3.79in wire 4.00in  
 wire R77 ( 82, 52) pad 12 distance 36mm 1.4in +2.3= 3.75in wire 4.00in  
 wire S83 ( 85, 36) pad 14 distance 34mm 1.3in +2.3= 3.64in wire 3.75in  
 wire Q76 ( 91, 66) pad 15 distance 37mm 1.5in +2.3= 3.79in wire 4.00in  
 wire S82 (102, 36) pad 16 distance 34mm 1.3in +2.3= 3.64in wire 3.75in  
 wire Q75 (107, 66) pad 17 distance 39mm 1.5in +2.3= 3.85in wire 4.00in  
 wire R76 ( 99, 52) pad 18 distance 36mm 1.4in +2.3= 3.73in wire 3.75in  
 wire Q74 (124, 67) pad 19 distance 43mm 1.7in +2.3= 4.02in wire 4.50in  
 wire R75 (116, 52) pad 20 distance 37mm 1.5in +2.3= 3.79in wire 4.00in  
 wire Q73 (140, 68) pad 21 distance 49mm 1.9in +2.3= 4.24in wire 4.50in  
 wire R74 (133, 54) pad 22 distance 42mm 1.6in +2.3= 3.97in wire 4.00in  
 wire R73 (150, 56) pad 23 distance 57mm 2.2in +2.3= 4.56in wire 5.00in

Longest wire R73 at 115.9mm 4.56in Mean dist 98.4mm 3.88in

6 3.75-inch wires 12 4-inch wires 4 4.5-inch wires 1 5-inch wires 0 longer wires

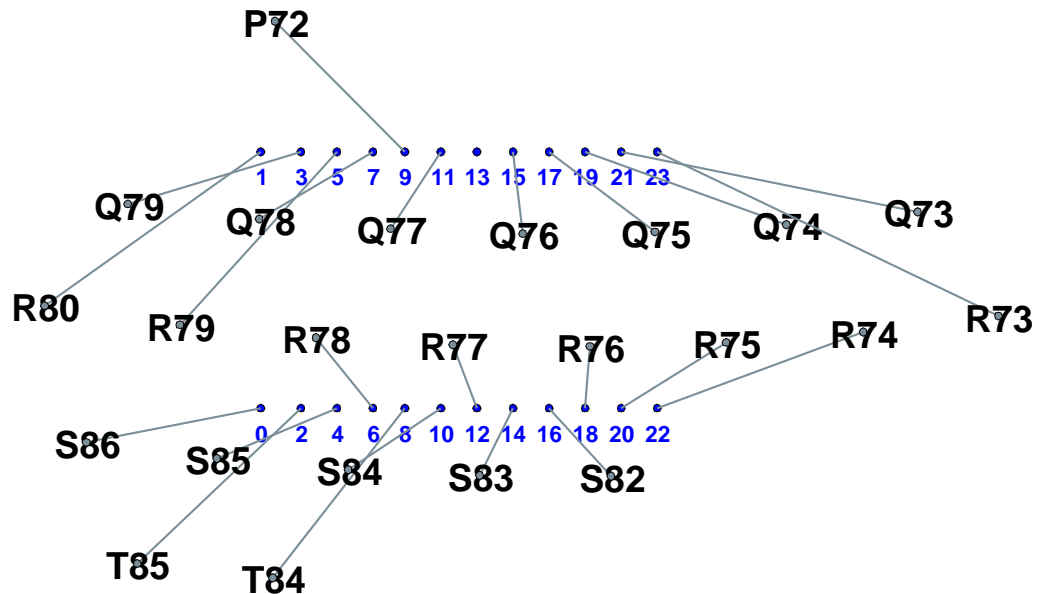

## F12

wire R87 ( 31, 57) pad 0 distance 44mm 1.7in +2.3= 4.05in wire 4.50in  
 wire Q87 ( 25, 72) pad 1 distance 44mm 1.7in +2.3= 4.06in wire 4.50in  
 wire S94 ( 29, 41) pad 2 distance 44mm 1.8in +2.3= 4.07in wire 4.50in  
 wire P80 ( 34, 96) pad 3 distance 43mm 1.7in +2.3= 4.03in wire 4.50in  
 wire S93 ( 46, 38) pad 4 distance 38mm 1.5in +2.3= 3.81in wire 4.00in  
 wire Q86 ( 41, 70) pad 5 distance 42mm 1.6in +2.3= 3.97in wire 4.00in  
 wire R86 ( 48, 54) pad 6 distance 40mm 1.6in +2.3= 3.89in wire 4.00in  
 wire P79 ( 51, 93) pad 7 distance 39mm 1.5in +2.3= 3.86in wire 4.00in  
 wire S92 ( 62, 37) pad 8 distance 36mm 1.4in +2.3= 3.72in wire 3.75in  
 wire Q85 ( 58, 68) pad 9 distance 40mm 1.6in +2.3= 3.91in wire 4.00in  
 wire S91 ( 78, 36) pad 10 distance 33mm 1.3in +2.3= 3.62in wire 3.75in  
 wire R85 ( 65, 53) pad 11 distance 47mm 1.9in +2.3= 4.18in wire 4.50in  
 wire R84 ( 82, 52) pad 12 distance 36mm 1.4in +2.3= 3.75in wire 4.00in  
 wire Q84 ( 74, 66) pad 13 distance 38mm 1.5in +2.3= 3.84in wire 4.00in  
 wire S90 ( 95, 36) pad 14 distance 33mm 1.3in +2.3= 3.63in wire 3.75in  
 wire Q83 ( 91, 66) pad 15 distance 37mm 1.5in +2.3= 3.79in wire 4.00in  
 wire R83 ( 99, 52) pad 16 distance 36mm 1.4in +2.3= 3.75in wire 3.75in  
 wire Q82 (107, 66) pad 17 distance 39mm 1.5in +2.3= 3.85in wire 4.00in  
 wire S89 (111, 36) pad 18 distance 35mm 1.4in +2.3= 3.69in wire 3.75in  
 wire R82 (116, 52) pad 19 distance 48mm 1.9in +2.3= 4.19in wire 4.50in  
 wire S88 (128, 37) pad 20 distance 39mm 1.6in +2.3= 3.88in wire 4.00in  
 wire Q81 (124, 67) pad 21 distance 40mm 1.6in +2.3= 3.89in wire 4.00in  
 wire R81 (133, 54) pad 22 distance 42mm 1.6in +2.3= 3.97in wire 4.00in  
 wire Q80 (140, 69) pad 23 distance 45mm 1.8in +2.3= 4.11in wire 4.50in

Longest wire R82 at 106.5mm 4.19in Mean dist 99.0mm 3.90in

5 3.75-inch wires 12 4-inch wires 7 4.5-inch wires 0 5-inch wires 0 longer wires

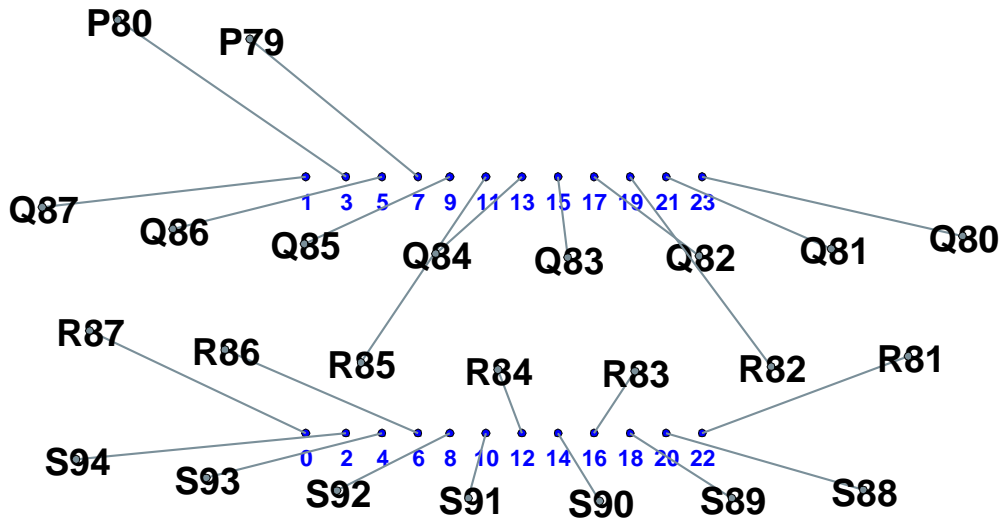

### F13

wire R95 ( 31, 57) pad 0 distance 44mm 1.7in +2.3= 4.05in wire 4.50in  
 wire Q95 ( 25, 72) pad 1 distance 44mm 1.7in +2.3= 4.06in wire 4.50in  
 wire S102 ( 40, 39) pad 2 distance 38mm 1.5in +2.3= 3.82in wire 4.00in  
 wire Q94 ( 41, 70) pad 3 distance 39mm 1.6in +2.3= 3.88in wire 4.00in  
 wire S101 ( 56, 37) pad 4 distance 34mm 1.3in +2.3= 3.66in wire 3.75in  
 wire R94 ( 48, 54) pad 5 distance 46mm 1.8in +2.3= 4.13in wire 4.50in  
 wire R93 ( 65, 53) pad 6 distance 34mm 1.3in +2.3= 3.65in wire 3.75in  
 wire Q93 ( 58, 68) pad 7 distance 38mm 1.5in +2.3= 3.82in wire 4.00in  
 wire T100 ( 64, 22) pad 8 distance 38mm 1.5in +2.3= 3.81in wire 4.00in  
 wire Q92 ( 74, 66) pad 9 distance 37mm 1.5in +2.3= 3.78in wire 4.00in  
 wire S100 ( 73, 36) pad 10 distance 34mm 1.3in +2.3= 3.65in wire 3.75in  
 wire R92 ( 82, 52) pad 11 distance 45mm 1.8in +2.3= 4.11in wire 4.50in  
 wire T99 ( 80, 22) pad 12 distance 37mm 1.4in +2.3= 3.77in wire 4.00in  
 wire S99 ( 89, 36) pad 14 distance 33mm 1.3in +2.3= 3.63in wire 3.75in  
 wire Q91 ( 91, 66) pad 15 distance 37mm 1.5in +2.3= 3.79in wire 4.00in  
 wire R91 ( 99, 52) pad 16 distance 36mm 1.4in +2.3= 3.75in wire 4.00in  
 wire P84 ( 91, 91) pad 17 distance 34mm 1.3in +2.3= 3.67in wire 3.75in  
 wire S98 (106, 36) pad 18 distance 33mm 1.3in +2.3= 3.64in wire 3.75in  
 wire Q90 (107, 66) pad 19 distance 38mm 1.5in +2.3= 3.80in wire 4.00in  
 wire R90 (116, 52) pad 20 distance 37mm 1.5in +2.3= 3.80in wire 4.00in  
 wire Q89 (124, 67) pad 21 distance 40mm 1.6in +2.3= 3.89in wire 4.00in  
 wire R89 (133, 54) pad 22 distance 42mm 1.7in +2.3= 3.97in wire 4.00in  
 wire Q88 (140, 69) pad 23 distance 45mm 1.8in +2.3= 4.11in wire 4.50in

Longest wire R94 at 104.9mm 4.13in Mean dist 97.4mm 3.84in

6 3.75-inch wires 12 4-inch wires 5 4.5-inch wires 0 5-inch wires 0 longer wires

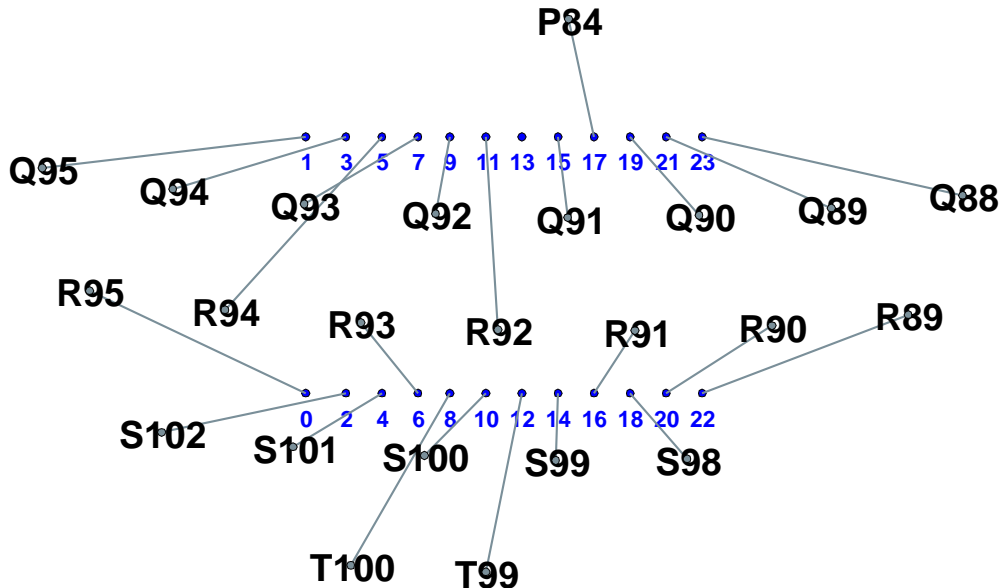



## F14

wire R103 ( 31, 57) pad 0 distance 44mm 1.7in +2.3= 4.05in wire 4.50in  
 wire Q103 ( 25, 72) pad 1 distance 44mm 1.7in +2.3= 4.06in wire 4.50in  
 wire S110 ( 51, 38) pad 2 distance 34mm 1.3in +2.3= 3.66in wire 3.75in  
 wire Q102 ( 41, 70) pad 3 distance 39mm 1.6in +2.3= 3.87in wire 4.00in  
 wire S109 ( 67, 36) pad 4 distance 33mm 1.3in +2.3= 3.63in wire 3.75in  
 wire R102 ( 48, 54) pad 5 distance 46mm 1.8in +2.3= 4.13in wire 4.50in  
 wire R101 ( 65, 53) pad 6 distance 34mm 1.3in +2.3= 3.65in wire 3.75in  
 wire Q101 ( 58, 68) pad 7 distance 38mm 1.5in +2.3= 3.82in wire 4.00in  
 wire T108 ( 75, 22) pad 8 distance 36mm 1.4in +2.3= 3.75in wire 3.75in  
 wire Q100 ( 74, 66) pad 9 distance 37mm 1.5in +2.3= 3.78in wire 4.00in  
 wire R100 ( 82, 52) pad 10 distance 36mm 1.4in +2.3= 3.75in wire 4.00in  
 wire P92 ( 81, 91) pad 11 distance 34mm 1.3in +2.3= 3.66in wire 3.75in  
 wire S108 ( 84, 36) pad 12 distance 33mm 1.3in +2.3= 3.62in wire 3.75in  
 wire Q99 ( 91, 66) pad 13 distance 38mm 1.5in +2.3= 3.80in wire 4.00in  
 wire T107 ( 92, 22) pad 14 distance 36mm 1.4in +2.3= 3.76in wire 4.00in  
 wire R99 ( 99, 52) pad 15 distance 46mm 1.8in +2.3= 4.14in wire 4.50in  
 wire S107 (100, 36) pad 16 distance 33mm 1.3in +2.3= 3.63in wire 3.75in  
 wire Q98 (107, 66) pad 17 distance 39mm 1.5in +2.3= 3.84in wire 4.00in  
 wire T106 (109, 22) pad 18 distance 38mm 1.5in +2.3= 3.80in wire 4.00in  
 wire R98 (116, 52) pad 19 distance 48mm 1.9in +2.3= 4.19in wire 4.50in  
 wire S106 (116, 36) pad 20 distance 35mm 1.4in +2.3= 3.69in wire 3.75in  
 wire Q97 (124, 67) pad 21 distance 40mm 1.6in +2.3= 3.89in wire 4.00in  
 wire R97 (133, 54) pad 22 distance 42mm 1.7in +2.3= 3.97in wire 4.00in  
 wire Q96 (140, 69) pad 23 distance 45mm 1.8in +2.3= 4.10in wire 4.50in

Longest wire R98 at 106.5mm 4.19in Mean dist 97.6mm 3.84in

8 3.75-inch wires 10 4-inch wires 6 4.5-inch wires 0 5-inch wires 0 longer wires

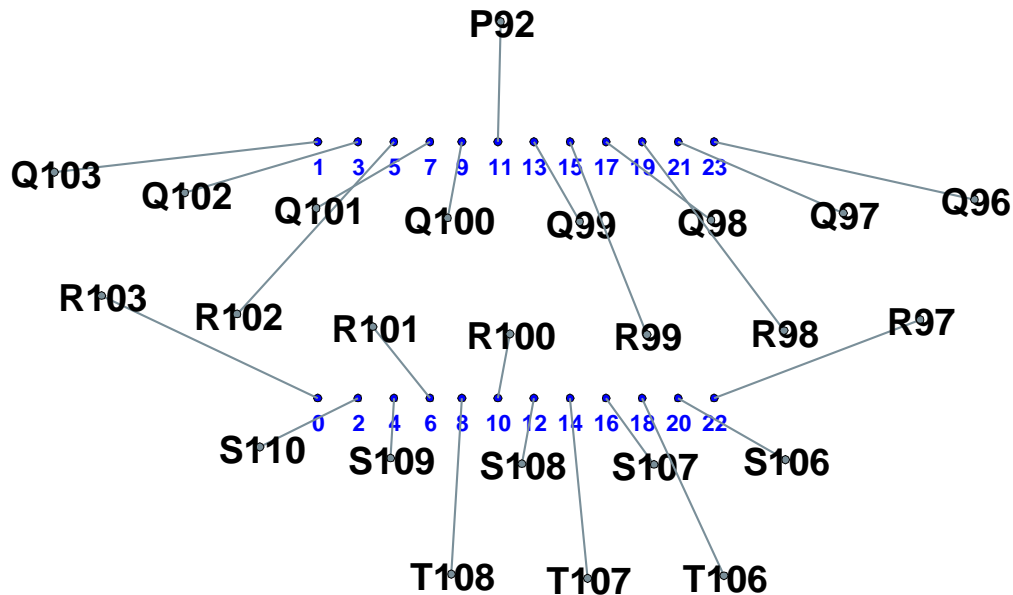

## F15

wire R111 ( 31, 57) pad 0 distance 44mm 1.7in +2.3= 4.06in wire 4.50in  
 wire Q111 ( 25, 72) pad 1 distance 44mm 1.7in +2.3= 4.06in wire 4.50in  
 wire S119 ( 45, 39) pad 2 distance 36mm 1.4in +2.3= 3.73in wire 3.75in  
 wire Q110 ( 41, 70) pad 3 distance 39mm 1.6in +2.3= 3.87in wire 4.00in  
 wire S118 ( 62, 37) pad 4 distance 33mm 1.3in +2.3= 3.63in wire 3.75in  
 wire R110 ( 48, 54) pad 5 distance 46mm 1.8in +2.3= 4.13in wire 4.50in  
 wire R109 ( 65, 53) pad 6 distance 34mm 1.3in +2.3= 3.65in wire 3.75in  
 wire Q109 ( 58, 68) pad 7 distance 38mm 1.5in +2.3= 3.82in wire 4.00in  
 wire S117 ( 78, 36) pad 8 distance 33mm 1.3in +2.3= 3.63in wire 3.75in  
 wire Q108 ( 74, 66) pad 9 distance 37mm 1.5in +2.3= 3.78in wire 4.00in  
 wire R108 ( 82, 52) pad 10 distance 36mm 1.4in +2.3= 3.75in wire 3.75in  
 wire Q107 ( 91, 66) pad 11 distance 39mm 1.5in +2.3= 3.85in wire 4.00in  
 wire S116 ( 94, 36) pad 12 distance 34mm 1.4in +2.3= 3.67in wire 3.75in  
 wire R107 ( 99, 52) pad 13 distance 48mm 1.9in +2.3= 4.20in wire 4.50in  
 wire T115 (103, 22) pad 14 distance 38mm 1.5in +2.3= 3.83in wire 4.00in  
 wire Q106 (107, 66) pad 15 distance 41mm 1.6in +2.3= 3.93in wire 4.00in  
 wire S115 (111, 36) pad 16 distance 36mm 1.4in +2.3= 3.75in wire 3.75in  
 wire P97 (121, 92) pad 17 distance 42mm 1.7in +2.3= 3.98in wire 4.00in  
 wire R106 (116, 52) pad 18 distance 39mm 1.5in +2.3= 3.86in wire 4.00in  
 wire Q105 (124, 67) pad 19 distance 43mm 1.7in +2.3= 4.02in wire 4.50in  
 wire S114 (127, 37) pad 20 distance 39mm 1.5in +2.3= 3.87in wire 4.00in  
 wire P96 (137, 93) pad 21 distance 46mm 1.8in +2.3= 4.14in wire 4.50in  
 wire R105 (133, 54) pad 22 distance 42mm 1.6in +2.3= 3.97in wire 4.00in  
 wire Q104 (140, 68) pad 23 distance 45mm 1.8in +2.3= 4.11in wire 4.50in

Longest wire R107 at 106.6mm 4.20in Mean dist 98.7mm 3.89in

7 3.75-inch wires 10 4-inch wires 7 4.5-inch wires 0 5-inch wires 0 longer wires

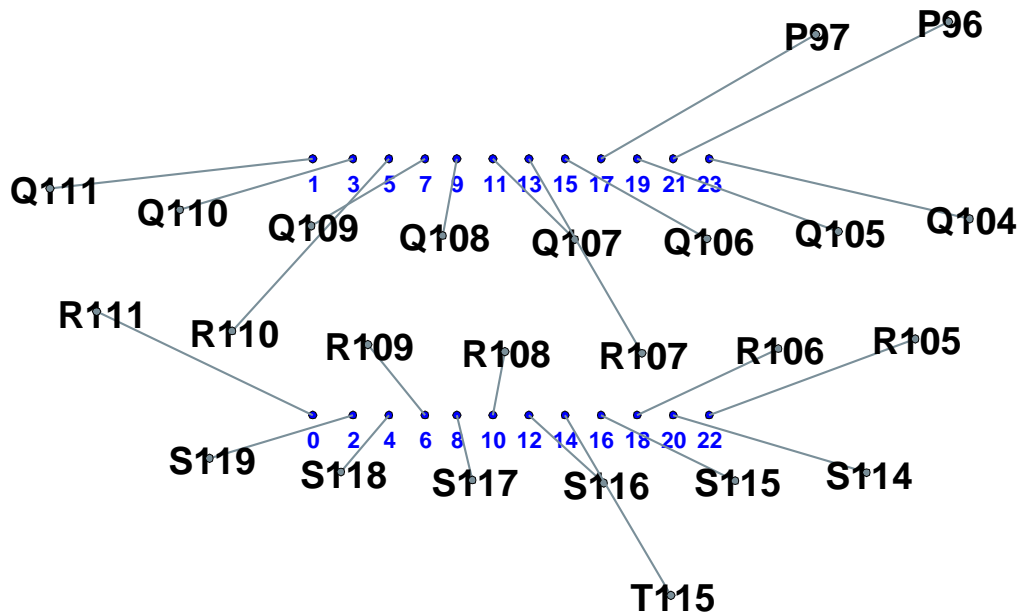

## F16

wire S127 ( 38, 40) pad 0 distance 37mm 1.4in +2.3= 3.76in wire 4.00in  
 wire Q118 ( 25, 72) pad 1 distance 44mm 1.7in +2.3= 4.06in wire 4.50in  
 wire R117 ( 48, 54) pad 2 distance 39mm 1.5in +2.3= 3.84in wire 4.00in  
 wire R118 ( 31, 57) pad 3 distance 50mm 2.0in +2.3= 4.29in wire 4.50in  
 wire S126 ( 54, 38) pad 4 distance 34mm 1.4in +2.3= 3.67in wire 3.75in  
 wire Q117 ( 41, 70) pad 5 distance 42mm 1.6in +2.3= 3.97in wire 4.00in  
 wire R116 ( 65, 53) pad 6 distance 34mm 1.3in +2.3= 3.65in wire 3.75in  
 wire Q116 ( 58, 68) pad 7 distance 38mm 1.5in +2.3= 3.82in wire 4.00in  
 wire S125 ( 71, 36) pad 8 distance 33mm 1.3in +2.3= 3.63in wire 3.75in  
 wire Q115 ( 74, 66) pad 9 distance 37mm 1.5in +2.3= 3.78in wire 4.00in  
 wire R115 ( 82, 52) pad 10 distance 36mm 1.4in +2.3= 3.75in wire 3.75in  
 wire P106 ( 79, 91) pad 11 distance 34mm 1.3in +2.3= 3.66in wire 3.75in  
 wire S124 ( 87, 36) pad 12 distance 33mm 1.3in +2.3= 3.63in wire 3.75in  
 wire Q114 ( 91, 66) pad 13 distance 38mm 1.5in +2.3= 3.80in wire 4.00in  
 wire R114 ( 99, 52) pad 14 distance 37mm 1.5in +2.3= 3.78in wire 4.00in  
 wire P105 ( 95, 91) pad 15 distance 34mm 1.4in +2.3= 3.67in wire 3.75in  
 wire S123 (104, 36) pad 16 distance 34mm 1.3in +2.3= 3.66in wire 3.75in  
 wire Q113 (107, 66) pad 17 distance 39mm 1.5in +2.3= 3.85in wire 4.00in  
 wire T122 (112, 22) pad 18 distance 39mm 1.5in +2.3= 3.84in wire 4.00in  
 wire P104 (112, 91) pad 19 distance 36mm 1.4in +2.3= 3.73in wire 3.75in  
 wire R113 (116, 52) pad 20 distance 37mm 1.5in +2.3= 3.79in wire 4.00in  
 wire Q112 (124, 67) pad 21 distance 40mm 1.6in +2.3= 3.89in wire 4.00in  
 wire S122 (120, 36) pad 22 distance 34mm 1.3in +2.3= 3.67in wire 3.75in  
 wire R112 (133, 54) pad 23 distance 48mm 1.9in +2.3= 4.23in wire 4.50in

Longest wire R118 at 109.0mm 4.29in Mean dist 96.8mm 3.81in

10 3.75-inch wires 11 4-inch wires 3 4.5-inch wires 0 5-inch wires 0 longer wires

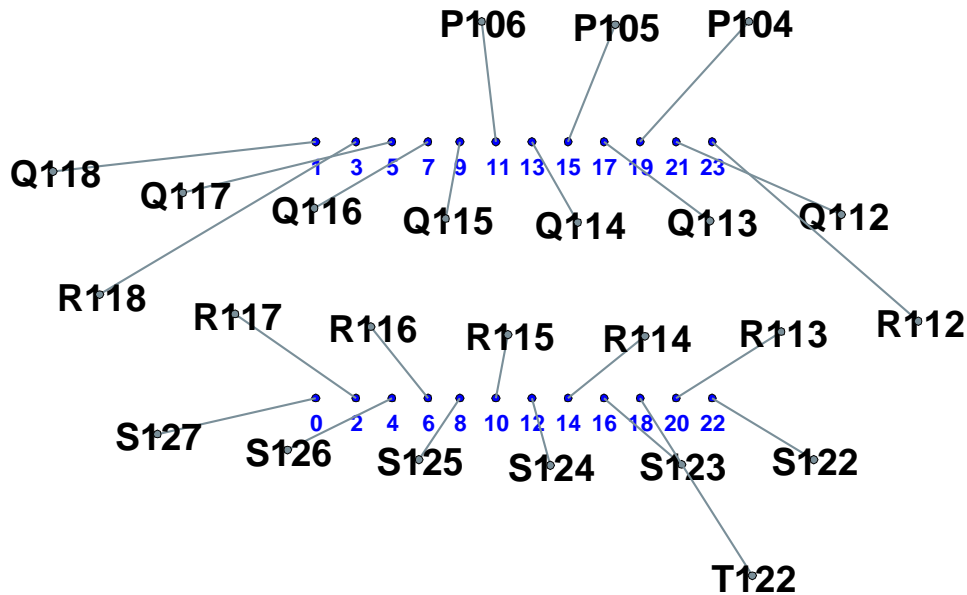

## F17

wire S137 ( 16, 43) pad 0 distance 50mm 2.0in +2.3= 4.30in wire 4.50in  
 wire R127 ( 14, 60) pad 1 distance 55mm 2.2in +2.3= 4.49in wire 4.50in  
 wire S136 ( 33, 40) pad 2 distance 42mm 1.7in +2.3= 3.99in wire 4.00in  
 wire R126 ( 31, 57) pad 3 distance 50mm 2.0in +2.3= 4.29in wire 4.50in  
 wire S135 ( 49, 38) pad 4 distance 36mm 1.4in +2.3= 3.75in wire 3.75in  
 wire Q125 ( 41, 70) pad 5 distance 42mm 1.6in +2.3= 3.97in wire 4.00in  
 wire R124 ( 65, 53) pad 6 distance 34mm 1.3in +2.3= 3.65in wire 3.75in  
 wire R125 ( 48, 54) pad 7 distance 48mm 1.9in +2.3= 4.23in wire 4.50in  
 wire S134 ( 65, 37) pad 8 distance 34mm 1.4in +2.3= 3.68in wire 3.75in  
 wire Q124 ( 58, 68) pad 9 distance 40mm 1.6in +2.3= 3.91in wire 4.00in  
 wire S133 ( 82, 36) pad 10 distance 33mm 1.3in +2.3= 3.62in wire 3.75in  
 wire Q123 ( 74, 66) pad 11 distance 37mm 1.5in +2.3= 3.79in wire 4.00in  
 wire R123 ( 82, 52) pad 12 distance 36mm 1.4in +2.3= 3.75in wire 4.00in  
 wire P113 ( 85, 91) pad 13 distance 34mm 1.3in +2.3= 3.66in wire 3.75in  
 wire S132 ( 98, 36) pad 14 distance 34mm 1.3in +2.3= 3.65in wire 3.75in  
 wire Q122 ( 91, 66) pad 15 distance 37mm 1.5in +2.3= 3.79in wire 4.00in  
 wire R122 ( 99, 52) pad 16 distance 36mm 1.4in +2.3= 3.75in wire 4.00in  
 wire Q121 (107, 66) pad 17 distance 39mm 1.5in +2.3= 3.84in wire 4.00in  
 wire S131 (115, 36) pad 18 distance 36mm 1.4in +2.3= 3.73in wire 3.75in  
 wire Q120 (124, 67) pad 19 distance 43mm 1.7in +2.3= 4.02in wire 4.50in  
 wire R121 (116, 52) pad 20 distance 37mm 1.5in +2.3= 3.80in wire 4.00in  
 wire R120 (133, 54) pad 21 distance 51mm 2.0in +2.3= 4.32in wire 4.50in  
 wire S130 (131, 37) pad 22 distance 38mm 1.5in +2.3= 3.82in wire 4.00in  
 wire Q119 (140, 69) pad 23 distance 45mm 1.8in +2.3= 4.11in wire 4.50in

Longest wire R127 at 114.2mm 4.49in Mean dist 99.4mm 3.91in

7 3.75-inch wires 10 4-inch wires 7 4.5-inch wires 0 5-inch wires 0 longer wires

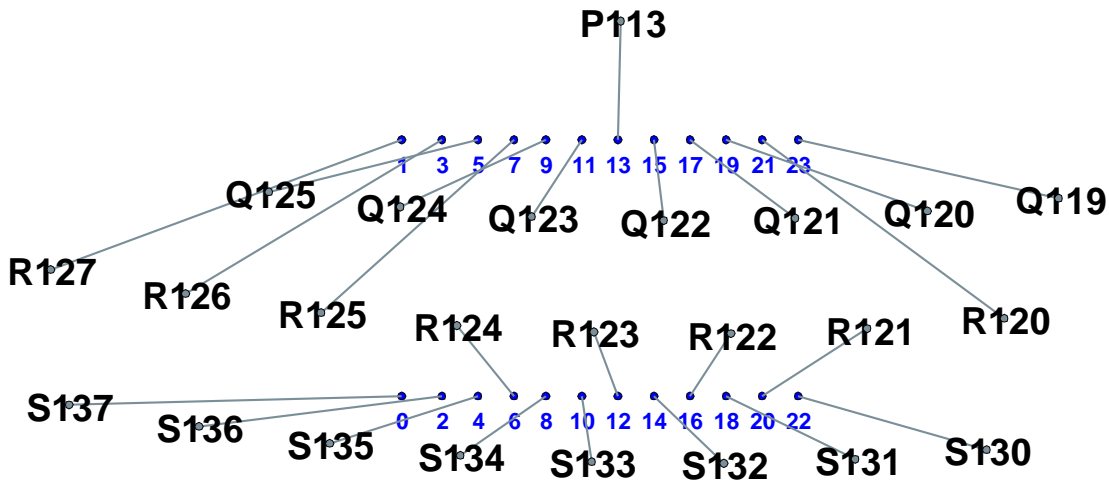

## F18

wire S145 ( 27, 41) pad 0 distance 43mm 1.7in +2.3= 4.00in wire 4.00in  
 wire R134 ( 31, 57) pad 1 distance 46mm 1.8in +2.3= 4.15in wire 4.50in  
 wire S144 ( 43, 39) pad 2 distance 37mm 1.4in +2.3= 3.76in wire 4.00in  
 wire Q133 ( 41, 70) pad 3 distance 39mm 1.6in +2.3= 3.88in wire 4.00in  
 wire S143 ( 60, 37) pad 4 distance 33mm 1.3in +2.3= 3.63in wire 3.75in  
 wire R133 ( 48, 54) pad 5 distance 46mm 1.8in +2.3= 4.13in wire 4.50in  
 wire R132 ( 65, 53) pad 6 distance 34mm 1.3in +2.3= 3.65in wire 3.75in  
 wire Q132 ( 58, 68) pad 7 distance 38mm 1.5in +2.3= 3.82in wire 4.00in  
 wire S142 ( 76, 36) pad 8 distance 33mm 1.3in +2.3= 3.62in wire 3.75in  
 wire Q131 ( 74, 66) pad 9 distance 37mm 1.5in +2.3= 3.78in wire 4.00in  
 wire R131 ( 82, 52) pad 10 distance 36mm 1.4in +2.3= 3.75in wire 3.75in  
 wire P121 ( 75, 91) pad 11 distance 34mm 1.4in +2.3= 3.67in wire 3.75in  
 wire S141 ( 93, 36) pad 12 distance 34mm 1.3in +2.3= 3.66in wire 3.75in  
 wire Q130 ( 91, 66) pad 13 distance 38mm 1.5in +2.3= 3.80in wire 4.00in  
 wire R130 ( 99, 52) pad 14 distance 37mm 1.5in +2.3= 3.78in wire 4.00in  
 wire P120 ( 92, 91) pad 15 distance 34mm 1.3in +2.3= 3.66in wire 3.75in  
 wire S140 (109, 36) pad 16 distance 35mm 1.4in +2.3= 3.72in wire 3.75in  
 wire Q129 (107, 66) pad 17 distance 39mm 1.5in +2.3= 3.85in wire 4.00in  
 wire S139 (125, 37) pad 18 distance 41mm 1.6in +2.3= 3.94in wire 4.00in  
 wire R129 (116, 52) pad 19 distance 48mm 1.9in +2.3= 4.19in wire 4.50in  
 wire T138 (135, 23) pad 20 distance 46mm 1.8in +2.3= 4.14in wire 4.50in  
 wire Q128 (124, 67) pad 21 distance 40mm 1.6in +2.3= 3.89in wire 4.00in  
 wire S138 (142, 38) pad 22 distance 44mm 1.8in +2.3= 4.07in wire 4.50in  
 wire R128 (133, 54) pad 23 distance 48mm 1.9in +2.3= 4.23in wire 4.50in

Longest wire R128 at 107.4mm 4.23in Mean dist 98.2mm 3.87in

8 3.75-inch wires 10 4-inch wires 6 4.5-inch wires 0 5-inch wires 0 longer wires

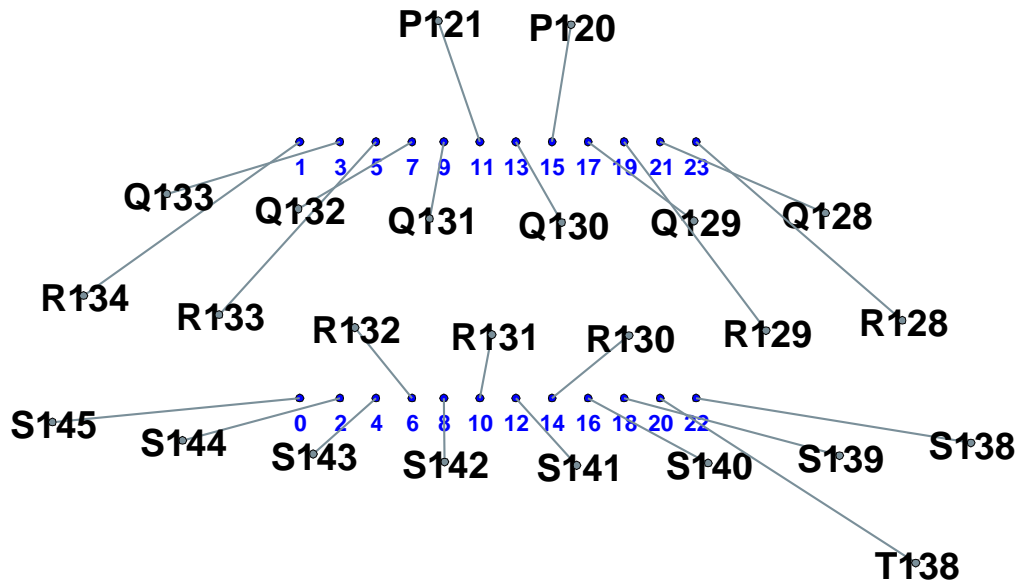

## F19

wire S154 ( 22, 42) pad 0 distance 46mm 1.8in +2.3= 4.15in wire 4.50in  
 wire R142 ( 31, 57) pad 1 distance 46mm 1.8in +2.3= 4.15in wire 4.50in  
 wire S153 ( 38, 40) pad 2 distance 39mm 1.5in +2.3= 3.87in wire 4.00in  
 wire Q141 ( 41, 70) pad 3 distance 39mm 1.6in +2.3= 3.87in wire 4.00in  
 wire S152 ( 54, 38) pad 4 distance 34mm 1.4in +2.3= 3.68in wire 3.75in  
 wire R141 ( 48, 54) pad 5 distance 46mm 1.8in +2.3= 4.13in wire 4.50in  
 wire R140 ( 65, 53) pad 6 distance 34mm 1.3in +2.3= 3.65in wire 3.75in  
 wire Q140 ( 58, 68) pad 7 distance 38mm 1.5in +2.3= 3.82in wire 4.00in  
 wire S151 ( 70, 36) pad 8 distance 33mm 1.3in +2.3= 3.63in wire 3.75in  
 wire Q139 ( 74, 66) pad 9 distance 37mm 1.5in +2.3= 3.78in wire 4.00in  
 wire R139 ( 82, 52) pad 10 distance 36mm 1.4in +2.3= 3.75in wire 3.75in  
 wire P128 ( 82, 91) pad 11 distance 34mm 1.3in +2.3= 3.66in wire 3.75in  
 wire S150 ( 87, 36) pad 12 distance 33mm 1.3in +2.3= 3.63in wire 3.75in  
 wire Q138 ( 91, 66) pad 13 distance 38mm 1.5in +2.3= 3.80in wire 4.00in  
 wire R138 ( 99, 52) pad 14 distance 37mm 1.5in +2.3= 3.78in wire 4.00in  
 wire P127 ( 99, 91) pad 15 distance 35mm 1.4in +2.3= 3.70in wire 3.75in  
 wire S149 (103, 36) pad 16 distance 34mm 1.3in +2.3= 3.65in wire 3.75in  
 wire Q137 (107, 66) pad 17 distance 39mm 1.5in +2.3= 3.85in wire 4.00in  
 wire R137 (116, 52) pad 18 distance 39mm 1.5in +2.3= 3.86in wire 4.00in  
 wire Q136 (124, 67) pad 19 distance 43mm 1.7in +2.3= 4.02in wire 4.50in  
 wire S148 (120, 36) pad 20 distance 36mm 1.4in +2.3= 3.73in wire 3.75in  
 wire R136 (133, 54) pad 21 distance 51mm 2.0in +2.3= 4.32in wire 4.50in  
 wire S147 (136, 38) pad 22 distance 41mm 1.6in +2.3= 3.93in wire 4.00in  
 wire R135 (150, 56) pad 23 distance 57mm 2.2in +2.3= 4.56in wire 5.00in

Longest wire R135 at 115.9mm 4.56in Mean dist 98.4mm 3.87in

9 3.75-inch wires 9 4-inch wires 5 4.5-inch wires 1 5-inch wires 0 longer wires

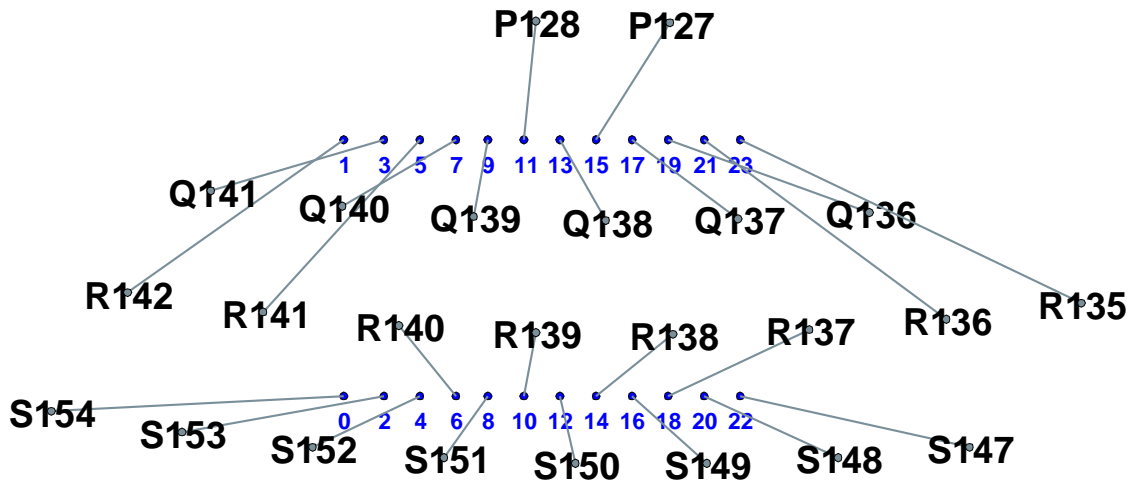

# G1

wire V2 ( 38, 40) pad 0 distance 37mm 1.4in +2.3= 3.77in wire 4.00in  
 wire T3 ( 25, 72) pad 1 distance 44mm 1.7in +2.3= 4.07in wire 4.50in  
 wire V1 ( 55, 38) pad 2 distance 33mm 1.3in +2.3= 3.63in wire 3.75in  
 wire U3 ( 31, 55) pad 3 distance 51mm 2.0in +2.3= 4.33in wire 4.50in  
 wire W1 ( 55, 22) pad 4 distance 38mm 1.5in +2.3= 3.81in wire 4.00in  
 wire T2 ( 42, 70) pad 5 distance 42mm 1.6in +2.3= 3.96in wire 4.00in  
 wire U1 ( 64, 52) pad 6 distance 34mm 1.3in +2.3= 3.65in wire 3.75in  
 wire U2 ( 48, 53) pad 7 distance 49mm 1.9in +2.3= 4.27in wire 4.50in  
 wire W182 ( 71, 22) pad 8 distance 37mm 1.4in +2.3= 3.77in wire 4.00in  
 wire T1 ( 58, 68) pad 9 distance 40mm 1.6in +2.3= 3.88in wire 4.00in  
 wire V170 ( 72, 38) pad 10 distance 34mm 1.3in +2.3= 3.66in wire 3.75in  
 wire T158 ( 75, 68) pad 11 distance 37mm 1.4in +2.3= 3.77in wire 4.00in  
 wire W181 ( 88, 21) pad 12 distance 37mm 1.4in +2.3= 3.77in wire 4.00in  
 wire U170 ( 80, 51) pad 13 distance 46mm 1.8in +2.3= 4.13in wire 4.50in  
 wire V169 ( 88, 37) pad 14 distance 33mm 1.3in +2.3= 3.63in wire 3.75in  
 wire T157 ( 92, 68) pad 15 distance 37mm 1.4in +2.3= 3.76in wire 4.00in  
 wire U169 ( 97, 52) pad 16 distance 36mm 1.4in +2.3= 3.74in wire 3.75in  
 wire T156 (109, 68) pad 17 distance 39mm 1.5in +2.3= 3.84in wire 4.00in  
 wire V168 (105, 38) pad 18 distance 33mm 1.3in +2.3= 3.63in wire 3.75in  
 wire T155 (126, 69) pad 19 distance 44mm 1.7in +2.3= 4.05in wire 4.50in  
 wire U168 (113, 52) pad 20 distance 37mm 1.4in +2.3= 3.76in wire 4.00in  
 wire T154 (143, 71) pad 21 distance 50mm 2.0in +2.3= 4.30in wire 4.50in  
 wire U167 (129, 53) pad 22 distance 40mm 1.6in +2.3= 3.89in wire 4.00in  
 wire U166 (146, 55) pad 23 distance 54mm 2.1in +2.3= 4.46in wire 4.50in

Longest wire U166 at 113.2mm 4.46in Mean dist 99.0mm 3.90in

6 3.75-inch wires 11 4-inch wires 7 4.5-inch wires 0 5-inch wires 0 longer wires

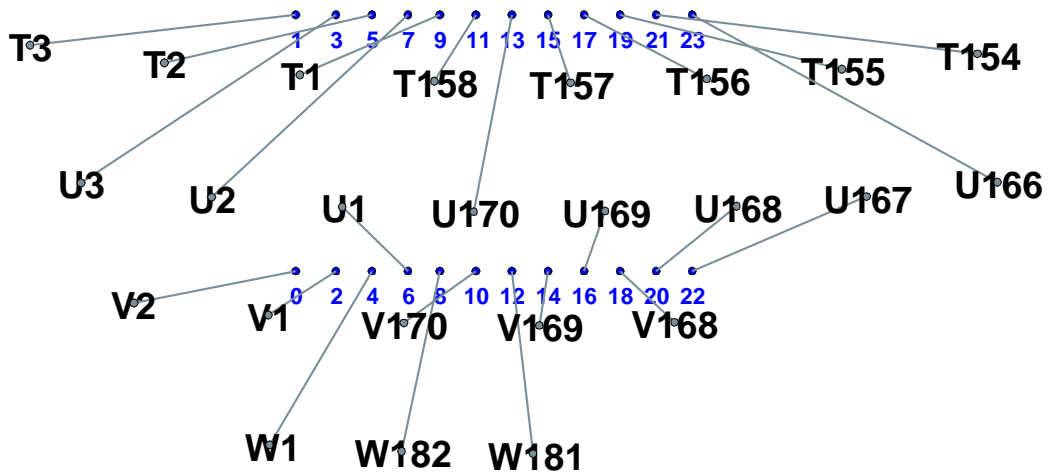

## G2

wire U11 ( 31, 52) pad 0 distance 42mm 1.7in +2.3= 3.98in wire 4.00in  
 wire T10 ( 32, 69) pad 1 distance 41mm 1.6in +2.3= 3.94in wire 4.00in  
 wire V9 ( 55, 36) pad 2 distance 33mm 1.3in +2.3= 3.63in wire 3.75in  
 wire U10 ( 48, 51) pad 3 distance 47mm 1.8in +2.3= 4.16in wire 4.50in  
 wire W9 ( 65, 20) pad 4 distance 38mm 1.5in +2.3= 3.80in wire 4.00in  
 wire T9 ( 49, 67) pad 5 distance 39mm 1.5in +2.3= 3.87in wire 4.00in  
 wire U9 ( 64, 50) pad 6 distance 33mm 1.3in +2.3= 3.64in wire 3.75in  
 wire T8 ( 66, 66) pad 7 distance 37mm 1.5in +2.3= 3.78in wire 4.00in  
 wire V8 ( 72, 36) pad 8 distance 33mm 1.3in +2.3= 3.63in wire 3.75in  
 wire W8 ( 81, 20) pad 10 distance 37mm 1.5in +2.3= 3.79in wire 4.00in  
 wire U8 ( 80, 50) pad 11 distance 47mm 1.8in +2.3= 4.15in wire 4.50in  
 wire V7 ( 89, 36) pad 12 distance 33mm 1.3in +2.3= 3.63in wire 3.75in  
 wire T7 ( 83, 66) pad 13 distance 37mm 1.5in +2.3= 3.78in wire 4.00in  
 wire W7 ( 98, 20) pad 14 distance 38mm 1.5in +2.3= 3.80in wire 4.00in  
 wire U7 ( 97, 51) pad 15 distance 47mm 1.8in +2.3= 4.16in wire 4.50in  
 wire V6 (106, 37) pad 16 distance 34mm 1.4in +2.3= 3.68in wire 3.75in  
 wire T6 (100, 67) pad 17 distance 37mm 1.5in +2.3= 3.78in wire 4.00in  
 wire U6 (113, 52) pad 18 distance 38mm 1.5in +2.3= 3.81in wire 4.00in  
 wire T5 (117, 68) pad 19 distance 39mm 1.6in +2.3= 3.88in wire 4.00in  
 wire V5 (123, 38) pad 20 distance 37mm 1.5in +2.3= 3.78in wire 4.00in  
 wire T4 (134, 70) pad 21 distance 44mm 1.7in +2.3= 4.06in wire 4.50in  
 wire U5 (130, 53) pad 22 distance 40mm 1.6in +2.3= 3.90in wire 4.00in  
 wire U4 (146, 56) pad 23 distance 54mm 2.1in +2.3= 4.45in wire 4.50in

Longest wire U4 at 113.1mm 4.45in Mean dist 98.4mm 3.87in

5 3.75-inch wires 13 4-inch wires 5 4.5-inch wires 0 5-inch wires 0 longer wires

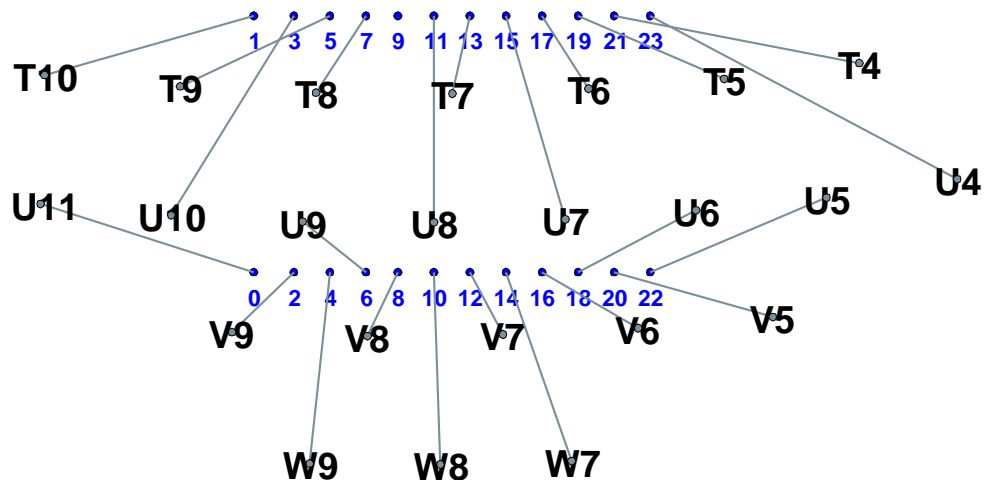



### G3

wire U18 ( 47, 53) pad 0 distance 36mm 1.4in +2.3= 3.76in wire 4.00in  
 wire U19 ( 31, 55) pad 1 distance 47mm 1.9in +2.3= 4.19in wire 4.50in  
 wire V17 ( 54, 38) pad 2 distance 33mm 1.3in +2.3= 3.64in wire 3.75in  
 wire T16 ( 56, 68) pad 3 distance 36mm 1.4in +2.3= 3.73in wire 3.75in  
 wire V16 ( 71, 37) pad 4 distance 34mm 1.3in +2.3= 3.65in wire 3.75in  
 wire U17 ( 64, 52) pad 5 distance 45mm 1.8in +2.3= 4.09in wire 4.50in  
 wire U16 ( 80, 51) pad 6 distance 35mm 1.4in +2.3= 3.70in wire 3.75in  
 wire T15 ( 73, 67) pad 7 distance 37mm 1.5in +2.3= 3.77in wire 4.00in  
 wire V15 ( 88, 36) pad 8 distance 36mm 1.4in +2.3= 3.72in wire 3.75in  
 wire S15 ( 82, 81) pad 9 distance 34mm 1.3in +2.3= 3.65in wire 3.75in  
 wire W16 ( 89, 20) pad 10 distance 38mm 1.5in +2.3= 3.82in wire 4.00in  
 wire T14 ( 90, 67) pad 11 distance 38mm 1.5in +2.3= 3.83in wire 4.00in  
 wire U15 ( 96, 51) pad 12 distance 37mm 1.5in +2.3= 3.80in wire 4.00in  
 wire S14 ( 99, 81) pad 13 distance 36mm 1.4in +2.3= 3.73in wire 3.75in  
 wire V14 (105, 37) pad 14 distance 36mm 1.4in +2.3= 3.73in wire 3.75in  
 wire T13 (107, 67) pad 15 distance 41mm 1.6in +2.3= 3.92in wire 4.00in  
 wire W15 (105, 21) pad 16 distance 38mm 1.5in +2.3= 3.82in wire 4.00in  
 wire S13 (115, 82) pad 17 distance 38mm 1.5in +2.3= 3.83in wire 4.00in  
 wire U14 (113, 51) pad 18 distance 37mm 1.5in +2.3= 3.80in wire 4.00in  
 wire T12 (124, 68) pad 19 distance 43mm 1.7in +2.3= 4.02in wire 4.50in  
 wire V13 (122, 37) pad 20 distance 37mm 1.4in +2.3= 3.77in wire 4.00in  
 wire T11 (141, 69) pad 21 distance 49mm 1.9in +2.3= 4.26in wire 4.50in  
 wire U13 (129, 52) pad 22 distance 39mm 1.6in +2.3= 3.88in wire 4.00in  
 wire U12 (146, 54) pad 23 distance 55mm 2.2in +2.3= 4.48in wire 4.50in

Longest wire U12 at 113.9mm 4.48in Mean dist 98.0mm 3.86in

8 3.75-inch wires 11 4-inch wires 5 4.5-inch wires 0 5-inch wires 0 longer wires

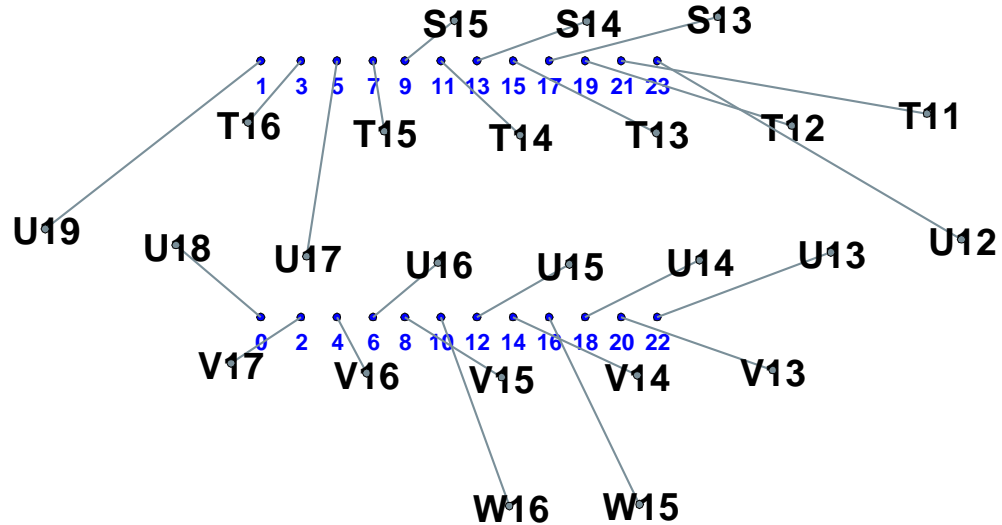

## G4

wire V26 ( 40, 38) pad 0 distance 36mm 1.4in +2.3= 3.74in wire 3.75in  
 wire U28 ( 16, 54) pad 1 distance 56mm 2.2in +2.3= 4.53in wire 5.00in  
 wire U26 ( 49, 51) pad 2 distance 37mm 1.5in +2.3= 3.78in wire 4.00in  
 wire U27 ( 32, 53) pad 3 distance 52mm 2.0in +2.3= 4.35in wire 4.50in  
 wire V25 ( 56, 37) pad 4 distance 34mm 1.3in +2.3= 3.66in wire 3.75in  
 wire T24 ( 48, 68) pad 5 distance 40mm 1.6in +2.3= 3.88in wire 4.00in  
 wire U25 ( 65, 50) pad 6 distance 33mm 1.3in +2.3= 3.63in wire 3.75in  
 wire T23 ( 65, 67) pad 7 distance 37mm 1.5in +2.3= 3.78in wire 4.00in  
 wire V24 ( 73, 36) pad 8 distance 33mm 1.3in +2.3= 3.62in wire 3.75in  
 wire T22 ( 82, 66) pad 9 distance 37mm 1.5in +2.3= 3.80in wire 4.00in  
 wire U24 ( 82, 50) pad 10 distance 36mm 1.4in +2.3= 3.73in wire 3.75in  
 wire S22 ( 90, 81) pad 11 distance 34mm 1.4in +2.3= 3.68in wire 3.75in  
 wire V23 ( 90, 36) pad 12 distance 33mm 1.3in +2.3= 3.64in wire 3.75in  
 wire T21 ( 99, 67) pad 13 distance 39mm 1.5in +2.3= 3.86in wire 4.00in  
 wire U23 ( 98, 51) pad 14 distance 36mm 1.4in +2.3= 3.76in wire 4.00in  
 wire S21 (106, 82) pad 15 distance 37mm 1.4in +2.3= 3.77in wire 4.00in  
 wire V22 (107, 37) pad 16 distance 35mm 1.4in +2.3= 3.69in wire 3.75in  
 wire U22 (114, 52) pad 17 distance 49mm 1.9in +2.3= 4.25in wire 4.50in  
 wire W23 (117, 22) pad 18 distance 40mm 1.6in +2.3= 3.90in wire 4.00in  
 wire T20 (116, 68) pad 19 distance 39mm 1.5in +2.3= 3.86in wire 4.00in  
 wire V21 (124, 39) pad 20 distance 38mm 1.5in +2.3= 3.80in wire 4.00in  
 wire T19 (132, 70) pad 21 distance 43mm 1.7in +2.3= 4.03in wire 4.50in  
 wire U21 (131, 54) pad 22 distance 41mm 1.6in +2.3= 3.92in wire 4.00in  
 wire U20 (147, 56) pad 23 distance 55mm 2.1in +2.3= 4.47in wire 4.50in

Longest wire U28 at 115.1mm 4.53in Mean dist 98.6mm 3.88in

8 3.75-inch wires 11 4-inch wires 4 4.5-inch wires 1 5-inch wires 0 longer wires

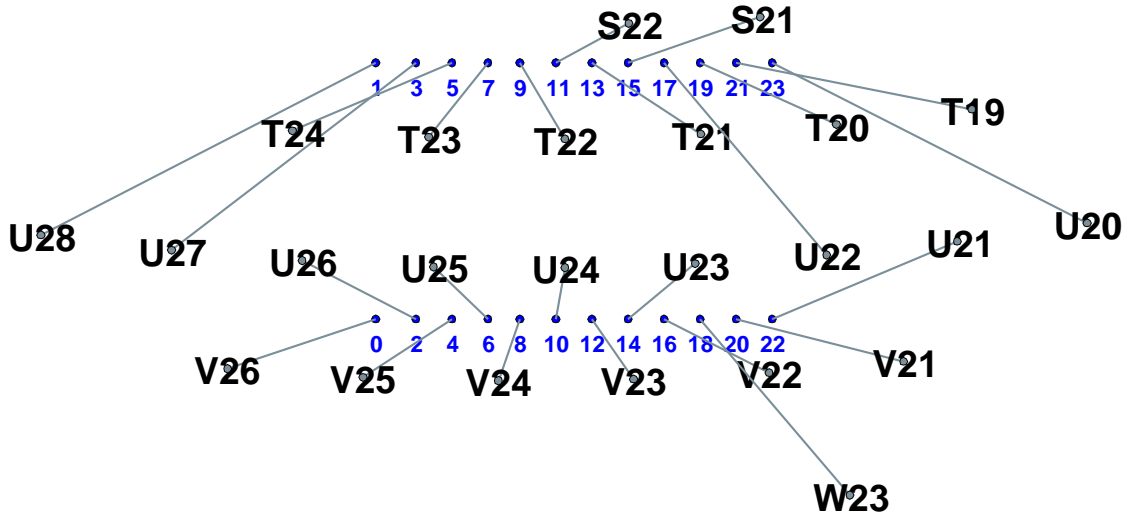

## G5

wire U35 ( 31, 54) pad 0 distance 43mm 1.7in +2.3= 4.02in wire 4.50in  
 wire U36 ( 15, 57) pad 1 distance 56mm 2.2in +2.3= 4.52in wire 5.00in  
 wire V34 ( 38, 40) pad 2 distance 39mm 1.5in +2.3= 3.87in wire 4.00in  
 wire T32 ( 37, 70) pad 3 distance 41mm 1.6in +2.3= 3.95in wire 4.00in  
 wire V33 ( 55, 38) pad 4 distance 34mm 1.3in +2.3= 3.67in wire 3.75in  
 wire T31 ( 54, 68) pad 5 distance 37mm 1.5in +2.3= 3.78in wire 4.00in  
 wire U34 ( 47, 53) pad 6 distance 40mm 1.6in +2.3= 3.89in wire 4.00in  
 wire T30 ( 71, 67) pad 7 distance 37mm 1.4in +2.3= 3.76in wire 4.00in  
 wire U33 ( 64, 52) pad 8 distance 38mm 1.5in +2.3= 3.81in wire 4.00in  
 wire S30 ( 80, 81) pad 9 distance 33mm 1.3in +2.3= 3.64in wire 3.75in  
 wire V32 ( 72, 37) pad 10 distance 34mm 1.3in +2.3= 3.66in wire 3.75in  
 wire T29 ( 88, 67) pad 11 distance 37mm 1.5in +2.3= 3.80in wire 4.00in  
 wire V31 ( 88, 37) pad 12 distance 33mm 1.3in +2.3= 3.63in wire 3.75in  
 wire U32 ( 80, 51) pad 13 distance 46mm 1.8in +2.3= 4.14in wire 4.50in  
 wire U31 ( 97, 51) pad 14 distance 36mm 1.4in +2.3= 3.75in wire 4.00in  
 wire R27 ( 94, 98) pad 15 distance 36mm 1.4in +2.3= 3.75in wire 3.75in  
 wire V30 (105, 37) pad 16 distance 34mm 1.4in +2.3= 3.67in wire 3.75in  
 wire S29 ( 96, 81) pad 17 distance 33mm 1.3in +2.3= 3.62in wire 3.75in  
 wire U30 (113, 52) pad 18 distance 38mm 1.5in +2.3= 3.81in wire 4.00in  
 wire T28 (105, 68) pad 19 distance 37mm 1.4in +2.3= 3.77in wire 4.00in  
 wire V29 (122, 38) pad 20 distance 37mm 1.4in +2.3= 3.77in wire 4.00in  
 wire T27 (122, 69) pad 21 distance 39mm 1.5in +2.3= 3.84in wire 4.00in  
 wire V28 (139, 40) pad 22 distance 43mm 1.7in +2.3= 4.00in wire 4.50in  
 wire U29 (129, 53) pad 23 distance 47mm 1.9in +2.3= 4.18in wire 4.50in

Longest wire U36 at 114.9mm 4.52in Mean dist 97.7mm 3.85in

7 3.75-inch wires 12 4-inch wires 4 4.5-inch wires 1 5-inch wires 0 longer wires

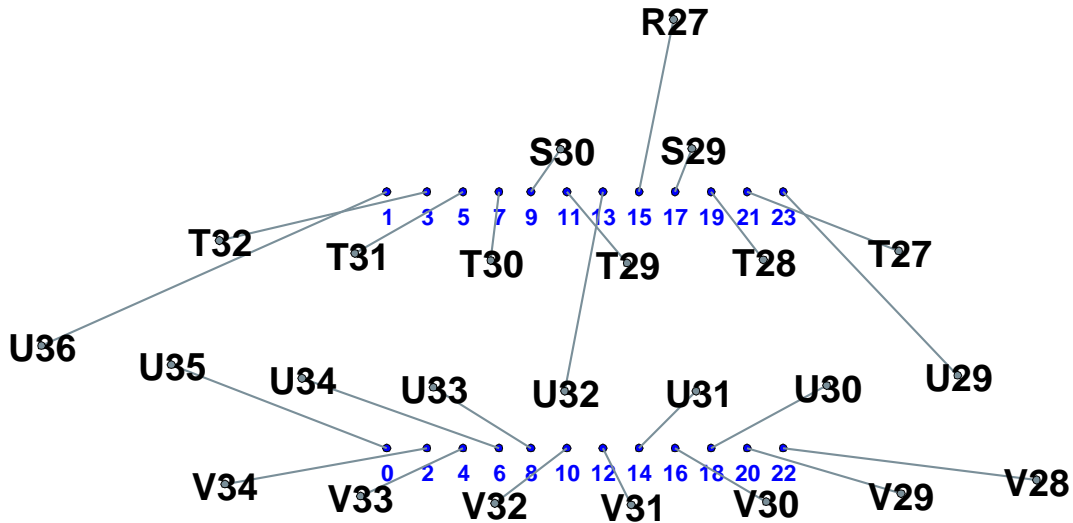

## G6

wire V43 ( 21, 42) pad 0 distance 47mm 1.8in +2.3= 4.16in wire 4.50in  
 wire U44 ( 15, 57) pad 1 distance 56mm 2.2in +2.3= 4.52in wire 5.00in  
 wire U43 ( 31, 55) pad 2 distance 46mm 1.8in +2.3= 4.14in wire 4.50in  
 wire T39 ( 44, 69) pad 3 distance 38mm 1.5in +2.3= 3.83in wire 4.00in  
 wire V42 ( 38, 40) pad 4 distance 42mm 1.7in +2.3= 3.98in wire 4.00in  
 wire S39 ( 54, 83) pad 5 distance 34mm 1.4in +2.3= 3.68in wire 3.75in  
 wire U42 ( 48, 53) pad 6 distance 40mm 1.6in +2.3= 3.89in wire 4.00in  
 wire T38 ( 61, 68) pad 7 distance 37mm 1.5in +2.3= 3.78in wire 4.00in  
 wire V41 ( 55, 38) pad 8 distance 39mm 1.5in +2.3= 3.85in wire 4.00in  
 wire S38 ( 70, 82) pad 9 distance 33mm 1.3in +2.3= 3.64in wire 3.75in  
 wire U41 ( 64, 52) pad 10 distance 40mm 1.6in +2.3= 3.88in wire 4.00in  
 wire R35 ( 74, 98) pad 11 distance 37mm 1.4in +2.3= 3.76in wire 4.00in  
 wire V40 ( 72, 37) pad 12 distance 36mm 1.4in +2.3= 3.72in wire 3.75in  
 wire T37 ( 78, 68) pad 13 distance 37mm 1.5in +2.3= 3.78in wire 4.00in  
 wire U40 ( 80, 51) pad 14 distance 38mm 1.5in +2.3= 3.80in wire 4.00in  
 wire S37 ( 87, 82) pad 15 distance 33mm 1.3in +2.3= 3.63in wire 3.75in  
 wire V39 ( 89, 37) pad 16 distance 34mm 1.3in +2.3= 3.65in wire 3.75in  
 wire T36 ( 95, 68) pad 17 distance 36mm 1.4in +2.3= 3.76in wire 4.00in  
 wire U39 ( 97, 52) pad 18 distance 36mm 1.4in +2.3= 3.74in wire 3.75in  
 wire S36 (103, 82) pad 19 distance 33mm 1.3in +2.3= 3.63in wire 3.75in  
 wire V38 (106, 38) pad 20 distance 33mm 1.3in +2.3= 3.62in wire 3.75in  
 wire T35 (112, 68) pad 21 distance 36mm 1.4in +2.3= 3.75in wire 3.75in  
 wire U38 (113, 52) pad 22 distance 36mm 1.4in +2.3= 3.72in wire 3.75in  
 wire U37 (129, 54) pad 23 distance 47mm 1.8in +2.3= 4.17in wire 4.50in

Longest wire U44 at 114.8mm 4.52in Mean dist 97.4mm 3.84in

10 3.75-inch wires 10 4-inch wires 3 4.5-inch wires 1 5-inch wires 0 longer wires

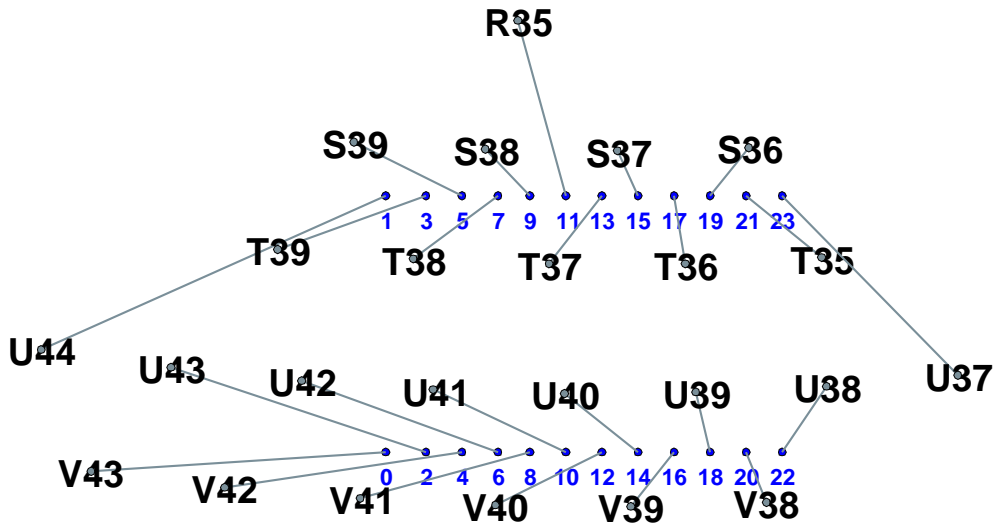

## G7

wire V51 ( 21, 41) pad 0 distance 46mm 1.8in +2.3= 4.15in wire 4.50in  
 wire U51 ( 31, 54) pad 1 distance 48mm 1.9in +2.3= 4.21in wire 4.50in  
 wire V50 ( 38, 39) pad 2 distance 39mm 1.5in +2.3= 3.86in wire 4.00in  
 wire T47 ( 35, 69) pad 3 distance 43mm 1.7in +2.3= 4.00in wire 4.00in  
 wire V49 ( 55, 37) pad 4 distance 34mm 1.3in +2.3= 3.67in wire 3.75in  
 wire T46 ( 52, 68) pad 5 distance 38mm 1.5in +2.3= 3.82in wire 4.00in  
 wire U50 ( 48, 52) pad 6 distance 39mm 1.6in +2.3= 3.88in wire 4.00in  
 wire S46 ( 62, 81) pad 7 distance 34mm 1.3in +2.3= 3.66in wire 3.75in  
 wire U49 ( 64, 51) pad 8 distance 37mm 1.5in +2.3= 3.79in wire 4.00in  
 wire T45 ( 69, 66) pad 9 distance 37mm 1.5in +2.3= 3.79in wire 4.00in  
 wire V48 ( 72, 36) pad 10 distance 34mm 1.3in +2.3= 3.66in wire 3.75in  
 wire S45 ( 78, 80) pad 11 distance 33mm 1.3in +2.3= 3.63in wire 3.75in  
 wire U48 ( 80, 50) pad 12 distance 36mm 1.4in +2.3= 3.73in wire 3.75in  
 wire T44 ( 86, 66) pad 13 distance 37mm 1.5in +2.3= 3.78in wire 4.00in  
 wire V47 ( 89, 36) pad 14 distance 33mm 1.3in +2.3= 3.63in wire 3.75in  
 wire U47 ( 97, 50) pad 16 distance 36mm 1.4in +2.3= 3.72in wire 3.75in  
 wire S44 ( 94, 80) pad 17 distance 33mm 1.3in +2.3= 3.63in wire 3.75in  
 wire V46 (106, 36) pad 18 distance 33mm 1.3in +2.3= 3.64in wire 3.75in  
 wire T43 (103, 66) pad 19 distance 37mm 1.5in +2.3= 3.78in wire 4.00in  
 wire U46 (113, 51) pad 20 distance 36mm 1.4in +2.3= 3.74in wire 3.75in  
 wire T42 (120, 67) pad 21 distance 38mm 1.5in +2.3= 3.83in wire 4.00in  
 wire V45 (122, 37) pad 22 distance 35mm 1.4in +2.3= 3.69in wire 3.75in  
 wire U45 (130, 52) pad 23 distance 48mm 1.9in +2.3= 4.21in wire 4.50in

Longest wire U51 at 107.0mm 4.21in Mean dist 96.6mm 3.80in

11 3.75-inch wires 9 4-inch wires 3 4.5-inch wires 0 5-inch wires 0 longer wires

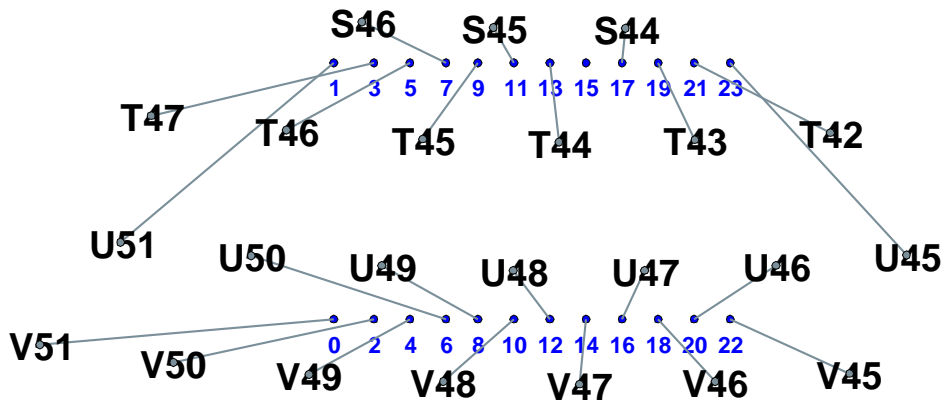

## G8

wire U59 ( 31, 55) pad 0 distance 43mm 1.7in +2.3= 4.02in wire 4.50in  
 wire T55 ( 26, 72) pad 1 distance 44mm 1.7in +2.3= 4.05in wire 4.50in  
 wire V58 ( 38, 40) pad 2 distance 39mm 1.5in +2.3= 3.87in wire 4.00in  
 wire T54 ( 42, 70) pad 3 distance 39mm 1.5in +2.3= 3.85in wire 4.00in  
 wire V57 ( 55, 38) pad 4 distance 34mm 1.4in +2.3= 3.67in wire 3.75in  
 wire S54 ( 52, 83) pad 5 distance 35mm 1.4in +2.3= 3.70in wire 3.75in  
 wire U58 ( 48, 53) pad 6 distance 40mm 1.6in +2.3= 3.89in wire 4.00in  
 wire R50 ( 53, 99) pad 7 distance 40mm 1.6in +2.3= 3.90in wire 4.00in  
 wire U57 ( 64, 52) pad 8 distance 38mm 1.5in +2.3= 3.81in wire 4.00in  
 wire T53 ( 59, 68) pad 9 distance 39mm 1.6in +2.3= 3.87in wire 4.00in  
 wire V56 ( 72, 37) pad 10 distance 34mm 1.3in +2.3= 3.66in wire 3.75in  
 wire S53 ( 68, 82) pad 11 distance 35mm 1.4in +2.3= 3.70in wire 3.75in  
 wire U56 ( 80, 51) pad 12 distance 36mm 1.4in +2.3= 3.75in wire 4.00in  
 wire T52 ( 76, 68) pad 13 distance 37mm 1.5in +2.3= 3.80in wire 4.00in  
 wire V55 ( 88, 37) pad 14 distance 33mm 1.3in +2.3= 3.63in wire 3.75in  
 wire T51 ( 93, 67) pad 15 distance 37mm 1.4in +2.3= 3.77in wire 4.00in  
 wire V54 (105, 37) pad 16 distance 34mm 1.3in +2.3= 3.67in wire 3.75in  
 wire U55 ( 97, 51) pad 17 distance 46mm 1.8in +2.3= 4.13in wire 4.50in  
 wire U54 (113, 52) pad 18 distance 38mm 1.5in +2.3= 3.81in wire 4.00in  
 wire T50 (110, 68) pad 19 distance 38mm 1.5in +2.3= 3.80in wire 4.00in  
 wire V53 (122, 38) pad 20 distance 37mm 1.4in +2.3= 3.77in wire 4.00in  
 wire T49 (127, 69) pad 21 distance 41mm 1.6in +2.3= 3.93in wire 4.00in  
 wire U53 (129, 53) pad 22 distance 40mm 1.6in +2.3= 3.89in wire 4.00in  
 wire U52 (146, 55) pad 23 distance 54mm 2.1in +2.3= 4.47in wire 4.50in

Longest wire U52 at 113.4mm 4.47in Mean dist 97.8mm 3.85in

6 3.75-inch wires 14 4-inch wires 4 4.5-inch wires 0 5-inch wires 0 longer wires

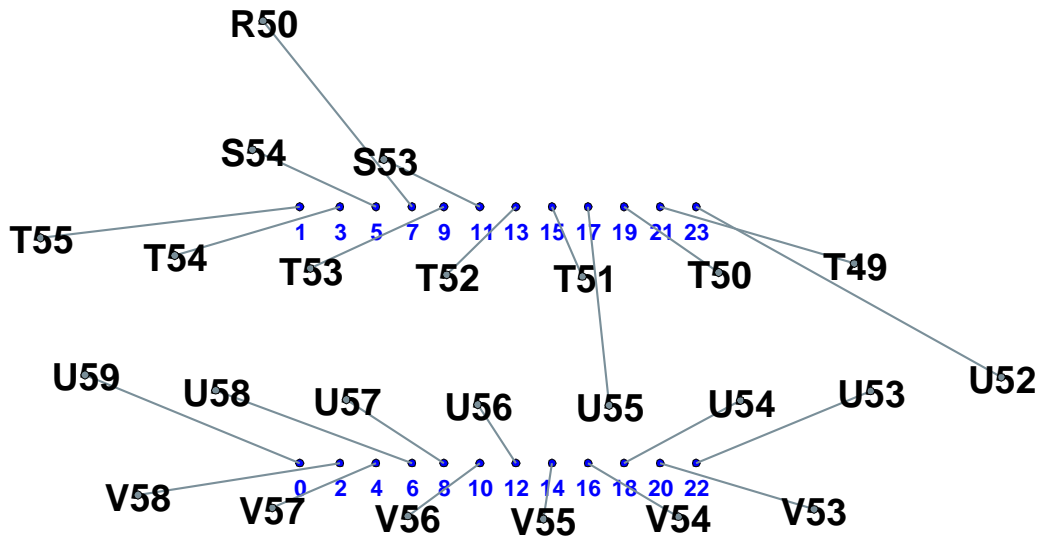

## G9

wire U67 ( 31, 54) pad 0 distance 43mm 1.7in +2.3= 4.01in wire 4.50in  
 wire T62 ( 33, 70) pad 1 distance 40mm 1.6in +2.3= 3.90in wire 4.00in  
 wire V66 ( 38, 39) pad 2 distance 39mm 1.5in +2.3= 3.87in wire 4.00in  
 wire S62 ( 43, 84) pad 3 distance 37mm 1.5in +2.3= 3.77in wire 4.00in  
 wire V65 ( 55, 38) pad 4 distance 34mm 1.3in +2.3= 3.67in wire 3.75in  
 wire U66 ( 48, 53) pad 5 distance 47mm 1.9in +2.3= 4.18in wire 4.50in  
 wire U65 ( 64, 52) pad 6 distance 34mm 1.3in +2.3= 3.65in wire 3.75in  
 wire T61 ( 50, 69) pad 7 distance 41mm 1.6in +2.3= 3.93in wire 4.00in  
 wire V64 ( 72, 37) pad 8 distance 33mm 1.3in +2.3= 3.63in wire 3.75in  
 wire T60 ( 67, 68) pad 9 distance 37mm 1.5in +2.3= 3.80in wire 4.00in  
 wire U64 ( 80, 51) pad 10 distance 36mm 1.4in +2.3= 3.73in wire 3.75in  
 wire V63 ( 88, 37) pad 12 distance 33mm 1.3in +2.3= 3.63in wire 3.75in  
 wire T59 ( 84, 67) pad 13 distance 37mm 1.4in +2.3= 3.77in wire 4.00in  
 wire U63 ( 97, 51) pad 14 distance 36mm 1.4in +2.3= 3.75in wire 4.00in  
 wire T58 (101, 67) pad 15 distance 38mm 1.5in +2.3= 3.82in wire 4.00in  
 wire V62 (105, 37) pad 16 distance 34mm 1.4in +2.3= 3.67in wire 3.75in  
 wire T57 (118, 68) pad 17 distance 42mm 1.7in +2.3= 3.98in wire 4.00in  
 wire U62 (113, 52) pad 18 distance 38mm 1.5in +2.3= 3.81in wire 4.00in  
 wire U61 (129, 53) pad 19 distance 53mm 2.1in +2.3= 4.40in wire 4.50in  
 wire V61 (122, 38) pad 20 distance 37mm 1.4in +2.3= 3.77in wire 4.00in  
 wire T56 (134, 70) pad 21 distance 45mm 1.8in +2.3= 4.08in wire 4.50in  
 wire V60 (139, 40) pad 22 distance 43mm 1.7in +2.3= 4.00in wire 4.50in  
 wire U60 (146, 55) pad 23 distance 54mm 2.1in +2.3= 4.46in wire 4.50in

Longest wire U60 at 113.3mm 4.46in Mean dist 98.6mm 3.88in

6 3.75-inch wires 11 4-inch wires 6 4.5-inch wires 0 5-inch wires 0 longer wires

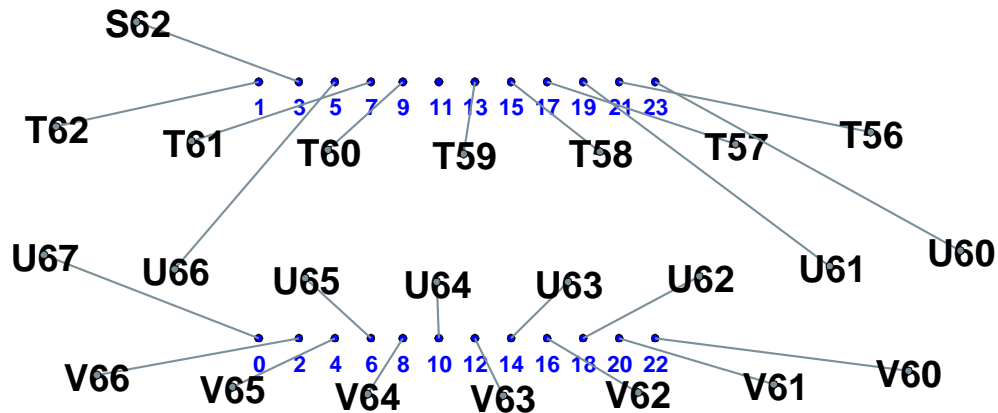

## G10

wire U75 ( 31, 55) pad 0 distance 43mm 1.7in +2.3= 4.02in wire 4.50in  
 wire T70 ( 23, 72) pad 1 distance 45mm 1.8in +2.3= 4.10in wire 4.50in  
 wire U74 ( 48, 53) pad 2 distance 38mm 1.5in +2.3= 3.82in wire 4.00in  
 wire S70 ( 34, 85) pad 3 distance 42mm 1.6in +2.3= 3.96in wire 4.00in  
 wire V73 ( 54, 38) pad 4 distance 34mm 1.4in +2.3= 3.67in wire 3.75in  
 wire T69 ( 40, 70) pad 5 distance 42mm 1.7in +2.3= 3.99in wire 4.00in  
 wire U73 ( 64, 52) pad 6 distance 34mm 1.3in +2.3= 3.65in wire 3.75in  
 wire T68 ( 57, 68) pad 7 distance 38mm 1.5in +2.3= 3.82in wire 4.00in  
 wire V72 ( 71, 37) pad 8 distance 33mm 1.3in +2.3= 3.63in wire 3.75in  
 wire T67 ( 74, 67) pad 9 distance 37mm 1.4in +2.3= 3.76in wire 4.00in  
 wire V71 ( 88, 37) pad 10 distance 34mm 1.3in +2.3= 3.66in wire 3.75in  
 wire U72 ( 80, 51) pad 11 distance 46mm 1.8in +2.3= 4.13in wire 4.50in  
 wire W76 ( 89, 21) pad 12 distance 37mm 1.5in +2.3= 3.78in wire 4.00in  
 wire T66 ( 91, 67) pad 13 distance 37mm 1.5in +2.3= 3.78in wire 4.00in  
 wire V70 (105, 37) pad 14 distance 36mm 1.4in +2.3= 3.74in wire 3.75in  
 wire U71 ( 96, 51) pad 15 distance 46mm 1.8in +2.3= 4.15in wire 4.50in  
 wire U70 (113, 52) pad 16 distance 40mm 1.6in +2.3= 3.89in wire 4.00in  
 wire T65 (108, 68) pad 17 distance 38mm 1.5in +2.3= 3.84in wire 4.00in  
 wire V69 (122, 38) pad 18 distance 39mm 1.5in +2.3= 3.86in wire 4.00in  
 wire T64 (125, 69) pad 19 distance 43mm 1.7in +2.3= 4.03in wire 4.50in  
 wire U69 (129, 53) pad 20 distance 43mm 1.7in +2.3= 4.02in wire 4.50in  
 wire T63 (142, 70) pad 21 distance 49mm 1.9in +2.3= 4.27in wire 4.50in  
 wire V68 (139, 40) pad 22 distance 43mm 1.7in +2.3= 4.00in wire 4.50in  
 wire U68 (146, 54) pad 23 distance 55mm 2.1in +2.3= 4.47in wire 4.50in

Longest wire U68 at 113.5mm 4.47in Mean dist 99.5mm 3.92in

5 3.75-inch wires 10 4-inch wires 9 4.5-inch wires 0 5-inch wires 0 longer wires

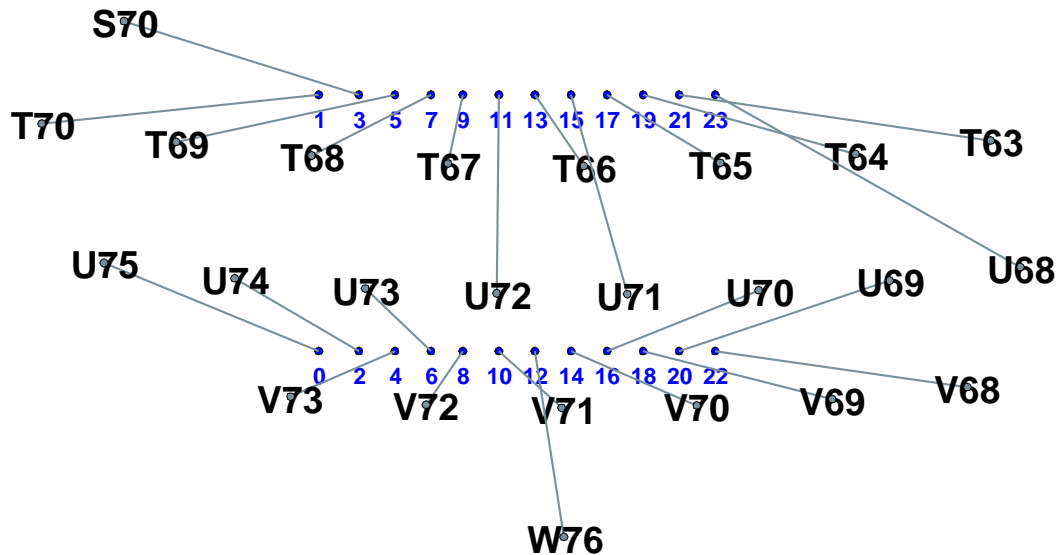



# G11

wire U83 ( 31, 54) pad 0 distance 43mm 1.7in +2.3= 4.01in wire 4.50in  
wire T77 ( 30, 71) pad 1 distance 41mm 1.6in +2.3= 3.95in wire 4.00in  
wire V81 ( 55, 38) pad 2 distance 33mm 1.3in +2.3= 3.63in wire 3.75in  
wire T76 ( 47, 69) pad 3 distance 37mm 1.5in +2.3= 3.79in wire 4.00in  
wire V80 ( 72, 37) pad 4 distance 34mm 1.3in +2.3= 3.66in wire 3.75in  
wire U82 ( 48, 53) pad 5 distance 47mm 1.9in +2.3= 4.18in wire 4.50in  
wire U81 ( 64, 52) pad 6 distance 34mm 1.3in +2.3= 3.65in wire 3.75in  
wire T75 ( 64, 68) pad 7 distance 37mm 1.4in +2.3= 3.77in wire 4.00in  
wire U80 ( 80, 51) pad 8 distance 36mm 1.4in +2.3= 3.75in wire 3.75in  
wire V79 ( 88, 37) pad 10 distance 34mm 1.3in +2.3= 3.66in wire 3.75in  
wire T74 ( 81, 67) pad 11 distance 37mm 1.4in +2.3= 3.77in wire 4.00in  
wire W84 ( 98, 21) pad 12 distance 39mm 1.5in +2.3= 3.86in wire 4.00in  
wire U79 ( 97, 51) pad 13 distance 47mm 1.9in +2.3= 4.18in wire 4.50in  
wire V78 (105, 37) pad 14 distance 36mm 1.4in +2.3= 3.74in wire 3.75in  
wire T73 ( 98, 67) pad 15 distance 37mm 1.5in +2.3= 3.80in wire 4.00in  
wire W83 (114, 22) pad 16 distance 41mm 1.6in +2.3= 3.93in wire 4.00in  
wire T72 (115, 68) pad 17 distance 41mm 1.6in +2.3= 3.94in wire 4.00in  
wire U78 (113, 52) pad 18 distance 38mm 1.5in +2.3= 3.81in wire 4.00in  
wire U77 (129, 53) pad 19 distance 53mm 2.1in +2.3= 4.40in wire 4.50in  
wire V77 (122, 38) pad 20 distance 37mm 1.4in +2.3= 3.77in wire 4.00in  
wire T71 (132, 70) pad 21 distance 43mm 1.7in +2.3= 4.03in wire 4.50in  
wire V76 (139, 40) pad 22 distance 43mm 1.7in +2.3= 4.00in wire 4.50in  
wire U76 (146, 55) pad 23 distance 54mm 2.1in +2.3= 4.46in wire 4.50in

Longest wire U76 at 113.2mm 4.46in Mean dist 99.1mm 3.90in

6 3.75-inch wires 10 4-inch wires 7 4.5-inch wires 0 5-inch wires 0 longer wires

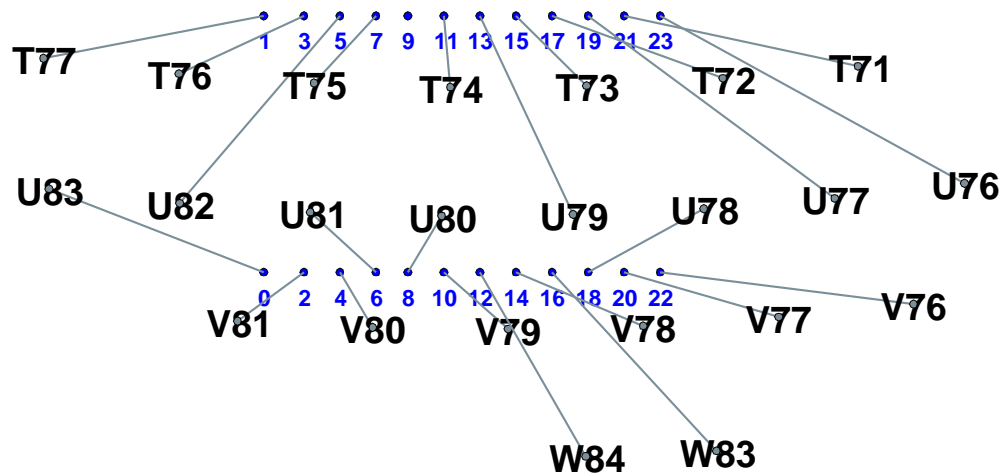

## G12

wire V90 ( 38, 40) pad 0 distance 37mm 1.4in +2.3= 3.77in wire 4.00in  
 wire U91 ( 31, 55) pad 1 distance 47mm 1.9in +2.3= 4.19in wire 4.50in  
 wire V89 ( 55, 38) pad 2 distance 33mm 1.3in +2.3= 3.63in wire 3.75in  
 wire U90 ( 48, 53) pad 3 distance 45mm 1.8in +2.3= 4.11in wire 4.50in  
 wire V88 ( 72, 37) pad 4 distance 34mm 1.3in +2.3= 3.66in wire 3.75in  
 wire T83 ( 55, 68) pad 5 distance 37mm 1.4in +2.3= 3.77in wire 4.00in  
 wire U89 ( 64, 52) pad 6 distance 34mm 1.3in +2.3= 3.65in wire 3.75in  
 wire T82 ( 72, 68) pad 7 distance 37mm 1.4in +2.3= 3.76in wire 4.00in  
 wire U88 ( 80, 51) pad 8 distance 36mm 1.4in +2.3= 3.75in wire 4.00in  
 wire T81 ( 89, 67) pad 9 distance 39mm 1.5in +2.3= 3.86in wire 4.00in  
 wire V87 ( 88, 37) pad 10 distance 34mm 1.3in +2.3= 3.66in wire 3.75in  
 wire S81 ( 97, 82) pad 11 distance 37mm 1.5in +2.3= 3.79in wire 4.00in  
 wire U87 ( 97, 51) pad 12 distance 38mm 1.5in +2.3= 3.81in wire 4.00in  
 wire T80 (106, 68) pad 13 distance 42mm 1.7in +2.3= 3.97in wire 4.00in  
 wire V86 (105, 37) pad 14 distance 36mm 1.4in +2.3= 3.74in wire 3.75in  
 wire S80 (113, 82) pad 15 distance 40mm 1.6in +2.3= 3.92in wire 4.00in  
 wire U86 (113, 52) pad 16 distance 40mm 1.6in +2.3= 3.90in wire 4.00in  
 wire T79 (123, 69) pad 17 distance 45mm 1.8in +2.3= 4.09in wire 4.50in  
 wire V85 (122, 38) pad 18 distance 39mm 1.5in +2.3= 3.87in wire 4.00in  
 wire S79 (130, 84) pad 19 distance 44mm 1.7in +2.3= 4.04in wire 4.50in  
 wire U85 (129, 53) pad 20 distance 43mm 1.7in +2.3= 4.02in wire 4.50in  
 wire T78 (140, 70) pad 21 distance 48mm 1.9in +2.3= 4.20in wire 4.50in  
 wire V84 (139, 40) pad 22 distance 43mm 1.7in +2.3= 4.00in wire 4.50in  
 wire U84 (146, 55) pad 23 distance 54mm 2.1in +2.3= 4.46in wire 4.50in

Longest wire U84 at 113.3mm 4.46in Mean dist 99.1mm 3.90in

5 3.75-inch wires 11 4-inch wires 8 4.5-inch wires 0 5-inch wires 0 longer wires

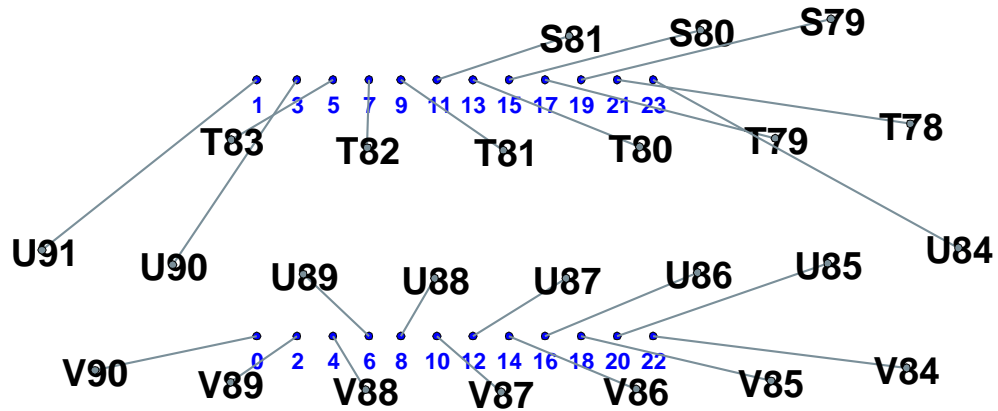

# G13

wire V99 ( 21, 41) pad 0 distance 47mm 1.8in +2.3= 4.16in wire 4.50in  
wire T92 ( 28, 71) pad 1 distance 42mm 1.7in +2.3= 4.00in wire 4.00in  
wire V98 ( 38, 39) pad 2 distance 39mm 1.5in +2.3= 3.86in wire 4.00in  
wire U99 ( 31, 54) pad 3 distance 51mm 2.0in +2.3= 4.34in wire 4.50in  
wire V97 ( 55, 38) pad 4 distance 34mm 1.3in +2.3= 3.67in wire 3.75in  
wire U98 ( 48, 53) pad 5 distance 47mm 1.9in +2.3= 4.18in wire 4.50in  
wire U97 ( 64, 52) pad 6 distance 34mm 1.3in +2.3= 3.65in wire 3.75in  
wire T91 ( 45, 69) pad 7 distance 43mm 1.7in +2.3= 4.02in wire 4.50in  
wire V96 ( 72, 37) pad 8 distance 33mm 1.3in +2.3= 3.63in wire 3.75in  
wire T90 ( 62, 68) pad 9 distance 38mm 1.5in +2.3= 3.84in wire 4.00in  
wire U96 ( 80, 51) pad 10 distance 36mm 1.4in +2.3= 3.74in wire 3.75in  
wire T89 ( 79, 68) pad 11 distance 36mm 1.4in +2.3= 3.76in wire 4.00in  
wire V95 ( 89, 37) pad 12 distance 33mm 1.3in +2.3= 3.63in wire 3.75in  
wire T88 ( 96, 68) pad 13 distance 38mm 1.5in +2.3= 3.82in wire 4.00in  
wire V94 (106, 38) pad 14 distance 36mm 1.4in +2.3= 3.74in wire 3.75in  
wire U95 ( 97, 52) pad 15 distance 46mm 1.8in +2.3= 4.13in wire 4.50in  
wire U94 (113, 52) pad 16 distance 40mm 1.6in +2.3= 3.91in wire 4.00in  
wire T87 (113, 69) pad 17 distance 40mm 1.6in +2.3= 3.89in wire 4.00in  
wire V93 (122, 39) pad 18 distance 39mm 1.5in +2.3= 3.87in wire 4.00in  
wire S87 (120, 83) pad 19 distance 38mm 1.5in +2.3= 3.83in wire 4.00in  
wire U93 (129, 54) pad 20 distance 43mm 1.7in +2.3= 4.03in wire 4.50in  
wire T86 (130, 70) pad 21 distance 42mm 1.6in +2.3= 3.97in wire 4.00in  
wire V92 (139, 41) pad 22 distance 43mm 1.7in +2.3= 4.01in wire 4.50in  
wire U92 (146, 56) pad 23 distance 54mm 2.1in +2.3= 4.44in wire 4.50in

Longest wire U92 at 112.8mm 4.44in Mean dist 99.6mm 3.92in

6 3.75-inch wires 10 4-inch wires 8 4.5-inch wires 0 5-inch wires 0 longer wires

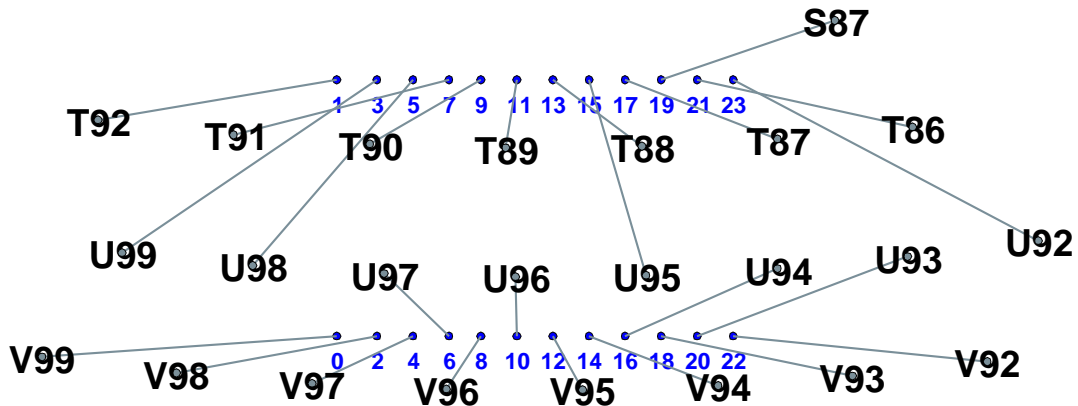

## G14

wire V106 ( 38, 39) pad 0 distance 37mm 1.4in +2.3= 3.77in wire 4.00in  
 wire U107 ( 31, 54) pad 1 distance 48mm 1.9in +2.3= 4.20in wire 4.50in  
 wire U106 ( 48, 53) pad 2 distance 38mm 1.5in +2.3= 3.81in wire 4.00in  
 wire T98 ( 52, 68) pad 3 distance 36mm 1.4in +2.3= 3.75in wire 4.00in  
 wire V105 ( 55, 38) pad 4 distance 34mm 1.3in +2.3= 3.67in wire 3.75in  
 wire T97 ( 70, 67) pad 5 distance 37mm 1.4in +2.3= 3.76in wire 4.00in  
 wire U105 ( 64, 52) pad 6 distance 34mm 1.3in +2.3= 3.65in wire 3.75in  
 wire S97 ( 78, 81) pad 7 distance 34mm 1.4in +2.3= 3.67in wire 3.75in  
 wire V104 ( 72, 37) pad 8 distance 33mm 1.3in +2.3= 3.63in wire 3.75in  
 wire T96 ( 86, 67) pad 9 distance 38mm 1.5in +2.3= 3.83in wire 4.00in  
 wire U104 ( 80, 51) pad 10 distance 36mm 1.4in +2.3= 3.74in wire 3.75in  
 wire S96 ( 95, 82) pad 11 distance 36mm 1.4in +2.3= 3.74in wire 3.75in  
 wire U103 ( 97, 51) pad 12 distance 38mm 1.5in +2.3= 3.81in wire 4.00in  
 wire T95 (103, 68) pad 13 distance 41mm 1.6in +2.3= 3.93in wire 4.00in  
 wire V102 (106, 38) pad 14 distance 36mm 1.4in +2.3= 3.74in wire 3.75in  
 wire R88 (108, 98) pad 15 distance 40mm 1.6in +2.3= 3.92in wire 4.00in  
 wire U102 (113, 52) pad 16 distance 40mm 1.6in +2.3= 3.90in wire 4.00in  
 wire S95 (111, 82) pad 17 distance 36mm 1.4in +2.3= 3.75in wire 3.75in  
 wire V101 (122, 39) pad 18 distance 39mm 1.5in +2.3= 3.87in wire 4.00in  
 wire T94 (120, 69) pad 19 distance 41mm 1.6in +2.3= 3.93in wire 4.00in  
 wire U101 (129, 53) pad 20 distance 43mm 1.7in +2.3= 4.02in wire 4.50in  
 wire T93 (137, 70) pad 21 distance 46mm 1.8in +2.3= 4.14in wire 4.50in  
 wire V100 (139, 40) pad 22 distance 43mm 1.7in +2.3= 4.01in wire 4.50in  
 wire U100 (146, 55) pad 23 distance 54mm 2.1in +2.3= 4.45in wire 4.50in

Longest wire U100 at 113.1mm 4.45in Mean dist 98.1mm 3.86in

8 3.75-inch wires 11 4-inch wires 5 4.5-inch wires 0 5-inch wires 0 longer wires

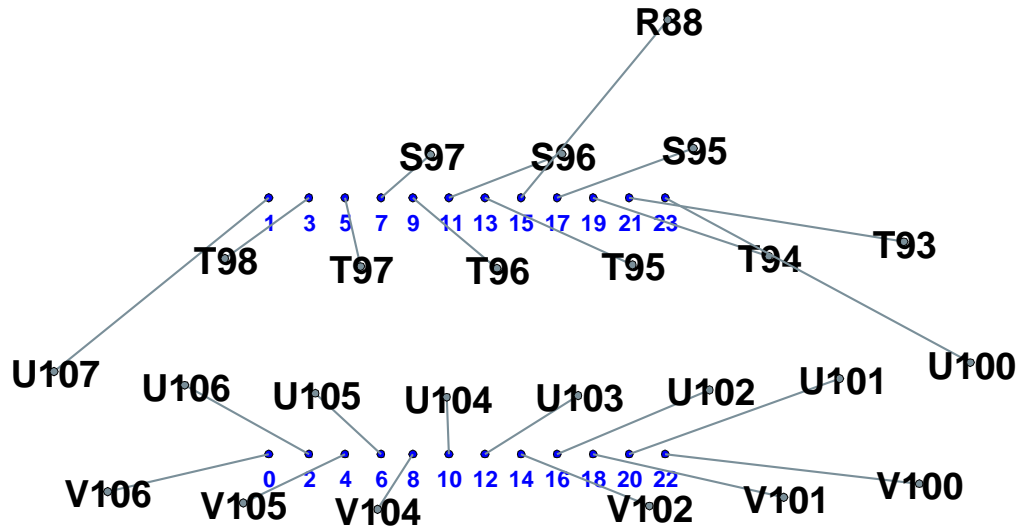

## G15

wire V115 ( 21, 42) pad 0 distance 47mm 1.8in +2.3= 4.16in wire 4.50in  
 wire U115 ( 31, 55) pad 1 distance 47mm 1.9in +2.3= 4.19in wire 4.50in  
 wire V114 ( 38, 40) pad 2 distance 39mm 1.5in +2.3= 3.87in wire 4.00in  
 wire U114 ( 48, 53) pad 3 distance 45mm 1.8in +2.3= 4.11in wire 4.50in  
 wire V113 ( 55, 38) pad 4 distance 34mm 1.3in +2.3= 3.67in wire 3.75in  
 wire T105 ( 60, 68) pad 5 distance 36mm 1.4in +2.3= 3.74in wire 3.75in  
 wire U113 ( 64, 52) pad 6 distance 34mm 1.3in +2.3= 3.65in wire 3.75in  
 wire S105 ( 69, 82) pad 7 distance 33mm 1.3in +2.3= 3.62in wire 3.75in  
 wire V112 ( 72, 38) pad 8 distance 33mm 1.3in +2.3= 3.63in wire 3.75in  
 wire T104 ( 77, 68) pad 9 distance 36mm 1.4in +2.3= 3.76in wire 4.00in  
 wire U112 ( 80, 52) pad 10 distance 36mm 1.4in +2.3= 3.74in wire 3.75in  
 wire S104 ( 85, 82) pad 11 distance 33mm 1.3in +2.3= 3.64in wire 3.75in  
 wire V111 ( 89, 37) pad 12 distance 33mm 1.3in +2.3= 3.63in wire 3.75in  
 wire R96 ( 89, 98) pad 13 distance 36mm 1.4in +2.3= 3.76in wire 4.00in  
 wire U111 ( 97, 52) pad 14 distance 37mm 1.4in +2.3= 3.76in wire 4.00in  
 wire T103 ( 94, 68) pad 15 distance 37mm 1.4in +2.3= 3.76in wire 4.00in  
 wire V110 (106, 38) pad 16 distance 34mm 1.4in +2.3= 3.68in wire 3.75in  
 wire S103 (102, 82) pad 17 distance 34mm 1.3in +2.3= 3.64in wire 3.75in  
 wire U110 (113, 52) pad 18 distance 38mm 1.5in +2.3= 3.82in wire 4.00in  
 wire T102 (111, 68) pad 19 distance 37mm 1.5in +2.3= 3.80in wire 4.00in  
 wire V109 (122, 39) pad 20 distance 37mm 1.4in +2.3= 3.77in wire 4.00in  
 wire T101 (128, 70) pad 21 distance 41mm 1.6in +2.3= 3.94in wire 4.00in  
 wire U109 (129, 54) pad 22 distance 40mm 1.6in +2.3= 3.90in wire 4.00in  
 wire U108 (146, 56) pad 23 distance 54mm 2.1in +2.3= 4.45in wire 4.50in

Longest wire U108 at 113.0mm 4.45in Mean dist 97.0mm 3.82in

10 3.75-inch wires 10 4-inch wires 4 4.5-inch wires 0 5-inch wires 0 longer wires

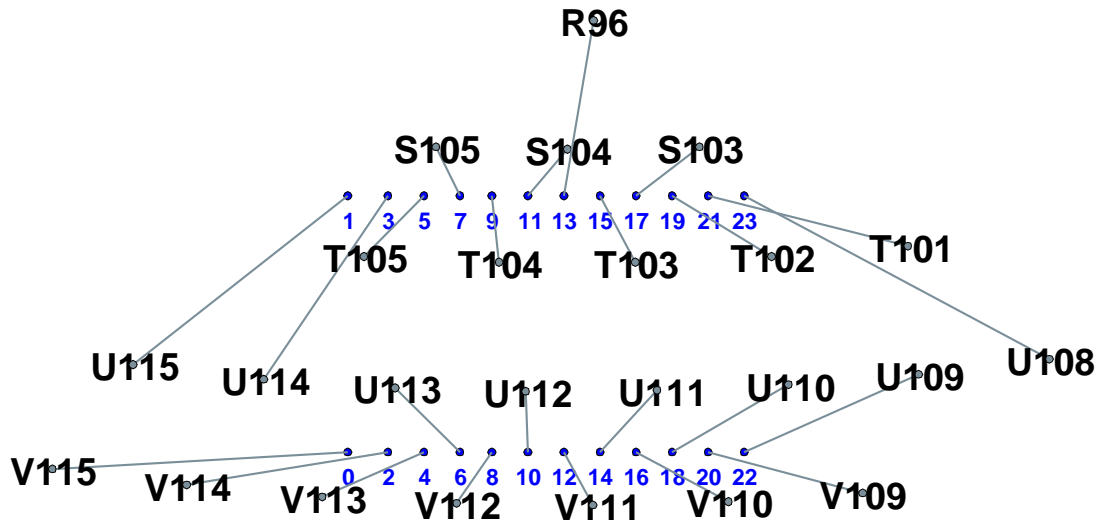

## G16

wire V122 ( 38, 39) pad 0 distance 37mm 1.4in +2.3= 3.77in wire 4.00in  
 wire U123 ( 31, 54) pad 1 distance 48mm 1.9in +2.3= 4.20in wire 4.50in  
 wire U122 ( 47, 53) pad 2 distance 38mm 1.5in +2.3= 3.82in wire 4.00in  
 wire T114 ( 34, 70) pad 3 distance 43mm 1.7in +2.3= 4.03in wire 4.50in  
 wire V121 ( 54, 38) pad 4 distance 34mm 1.4in +2.3= 3.67in wire 3.75in  
 wire T113 ( 50, 68) pad 5 distance 38mm 1.5in +2.3= 3.83in wire 4.00in  
 wire T112 ( 67, 67) pad 6 distance 38mm 1.5in +2.3= 3.83in wire 4.00in  
 wire S113 ( 60, 82) pad 7 distance 34mm 1.3in +2.3= 3.67in wire 3.75in  
 wire U121 ( 64, 51) pad 8 distance 38mm 1.5in +2.3= 3.81in wire 4.00in  
 wire R104 ( 70, 98) pad 9 distance 36mm 1.4in +2.3= 3.76in wire 4.00in  
 wire V120 ( 71, 37) pad 10 distance 34mm 1.3in +2.3= 3.67in wire 3.75in  
 wire S112 ( 76, 81) pad 11 distance 33mm 1.3in +2.3= 3.63in wire 3.75in  
 wire U120 ( 80, 51) pad 12 distance 36mm 1.4in +2.3= 3.74in wire 3.75in  
 wire T111 ( 84, 67) pad 13 distance 37mm 1.4in +2.3= 3.77in wire 4.00in  
 wire V119 ( 88, 37) pad 14 distance 33mm 1.3in +2.3= 3.63in wire 3.75in  
 wire S111 ( 93, 81) pad 15 distance 33mm 1.3in +2.3= 3.63in wire 3.75in  
 wire U119 ( 96, 51) pad 16 distance 36mm 1.4in +2.3= 3.73in wire 3.75in  
 wire T110 (101, 67) pad 17 distance 37mm 1.5in +2.3= 3.78in wire 4.00in  
 wire V118 (105, 37) pad 18 distance 33mm 1.3in +2.3= 3.63in wire 3.75in  
 wire U118 (113, 51) pad 19 distance 47mm 1.9in +2.3= 4.18in wire 4.50in  
 wire V117 (122, 38) pad 20 distance 37mm 1.4in +2.3= 3.77in wire 4.00in  
 wire T109 (118, 68) pad 21 distance 38mm 1.5in +2.3= 3.80in wire 4.00in  
 wire U117 (129, 53) pad 22 distance 40mm 1.6in +2.3= 3.88in wire 4.00in  
 wire U116 (146, 54) pad 23 distance 55mm 2.1in +2.3= 4.47in wire 4.50in

Longest wire U116 at 113.5mm 4.47in Mean dist 97.1mm 3.82in

9 3.75-inch wires 11 4-inch wires 4 4.5-inch wires 0 5-inch wires 0 longer wires

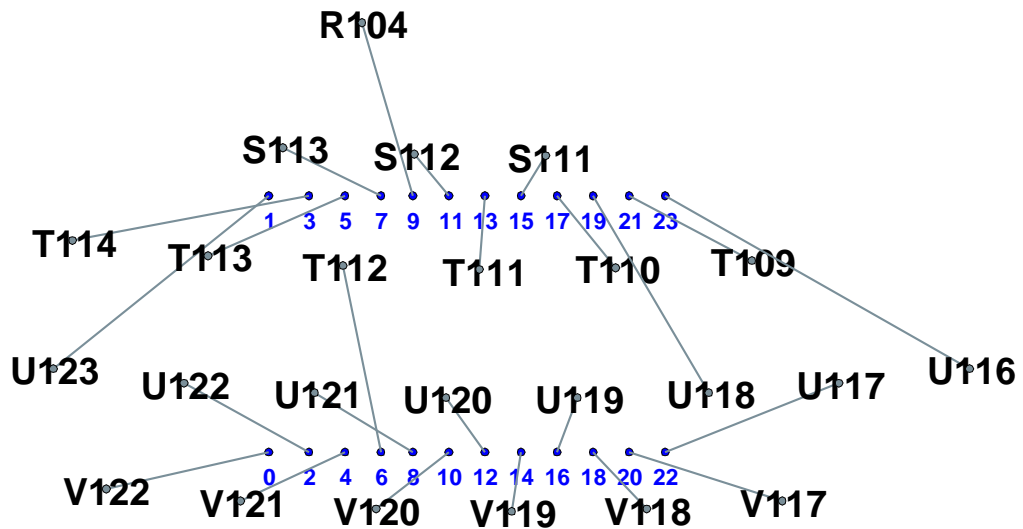

## G17

wire V130 ( 38, 40) pad 0 distance 37mm 1.4in +2.3= 3.77in wire 4.00in  
 wire U131 ( 31, 55) pad 1 distance 47mm 1.9in +2.3= 4.19in wire 4.50in  
 wire V129 ( 55, 38) pad 2 distance 33mm 1.3in +2.3= 3.63in wire 3.75in  
 wire T121 ( 41, 70) pad 3 distance 40mm 1.6in +2.3= 3.88in wire 4.00in  
 wire W138 ( 56, 22) pad 4 distance 38mm 1.5in +2.3= 3.80in wire 4.00in  
 wire U130 ( 48, 53) pad 5 distance 47mm 1.8in +2.3= 4.17in wire 4.50in  
 wire U129 ( 64, 52) pad 6 distance 34mm 1.3in +2.3= 3.65in wire 3.75in  
 wire S121 ( 51, 83) pad 7 distance 38mm 1.5in +2.3= 3.81in wire 4.00in  
 wire V128 ( 72, 38) pad 8 distance 33mm 1.3in +2.3= 3.63in wire 3.75in  
 wire T120 ( 58, 68) pad 9 distance 40mm 1.6in +2.3= 3.90in wire 4.00in  
 wire W137 ( 72, 21) pad 10 distance 37mm 1.5in +2.3= 3.79in wire 4.00in  
 wire S120 ( 67, 82) pad 11 distance 35mm 1.4in +2.3= 3.72in wire 3.75in  
 wire U128 ( 80, 51) pad 12 distance 36mm 1.4in +2.3= 3.75in wire 4.00in  
 wire T119 ( 75, 68) pad 13 distance 38mm 1.5in +2.3= 3.81in wire 4.00in  
 wire W136 ( 88, 21) pad 14 distance 37mm 1.4in +2.3= 3.77in wire 4.00in  
 wire T118 ( 92, 68) pad 15 distance 36mm 1.4in +2.3= 3.76in wire 4.00in  
 wire V127 ( 88, 37) pad 16 distance 34mm 1.3in +2.3= 3.66in wire 3.75in  
 wire U127 ( 97, 52) pad 17 distance 46mm 1.8in +2.3= 4.12in wire 4.50in  
 wire V126 (105, 38) pad 18 distance 33mm 1.3in +2.3= 3.63in wire 3.75in  
 wire T117 (109, 68) pad 19 distance 37mm 1.5in +2.3= 3.78in wire 4.00in  
 wire U126 (113, 52) pad 20 distance 37mm 1.4in +2.3= 3.76in wire 4.00in  
 wire T116 (126, 69) pad 21 distance 40mm 1.6in +2.3= 3.90in wire 4.00in  
 wire V125 (122, 39) pad 22 distance 35mm 1.4in +2.3= 3.68in wire 3.75in  
 wire U125 (129, 53) pad 23 distance 47mm 1.8in +2.3= 4.17in wire 4.50in

Longest wire U131 at 106.4mm 4.19in Mean dist 97.1mm 3.82in

7 3.75-inch wires 13 4-inch wires 4 4.5-inch wires 0 5-inch wires 0 longer wires

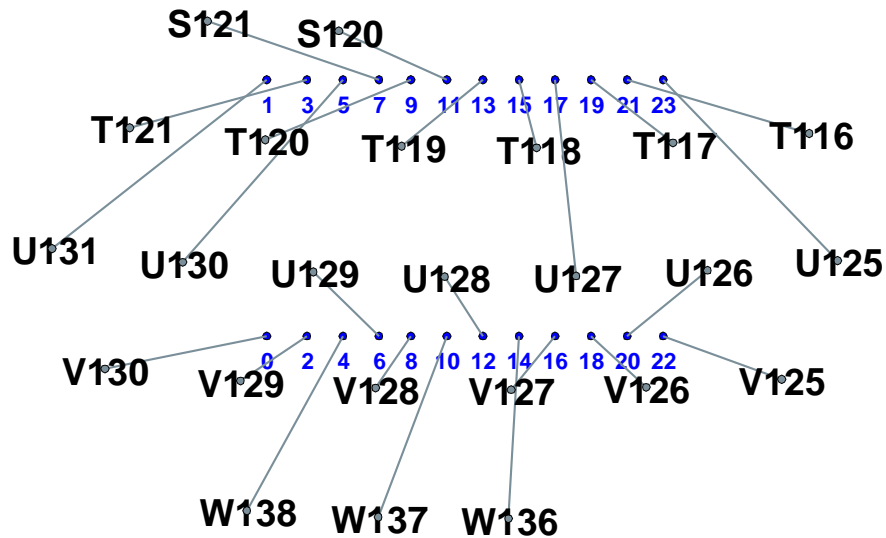

## G18

wire U139 ( 31, 54) pad 0 distance 43mm 1.7in +2.3= 4.01in wire 4.50in  
 wire T129 ( 31, 70) pad 1 distance 41mm 1.6in +2.3= 3.93in wire 4.00in  
 wire V138 ( 38, 39) pad 2 distance 39mm 1.5in +2.3= 3.86in wire 4.00in  
 wire S129 ( 41, 84) pad 3 distance 38mm 1.5in +2.3= 3.80in wire 4.00in  
 wire V137 ( 55, 38) pad 4 distance 34mm 1.3in +2.3= 3.67in wire 3.75in  
 wire T128 ( 48, 69) pad 5 distance 39mm 1.5in +2.3= 3.86in wire 4.00in  
 wire U138 ( 48, 52) pad 6 distance 40mm 1.6in +2.3= 3.88in wire 4.00in  
 wire R119 ( 48, 99) pad 7 distance 42mm 1.7in +2.3= 4.00in wire 4.00in  
 wire U137 ( 64, 52) pad 8 distance 38mm 1.5in +2.3= 3.81in wire 4.00in  
 wire S128 ( 57, 82) pad 9 distance 37mm 1.5in +2.3= 3.80in wire 4.00in  
 wire V136 ( 72, 37) pad 10 distance 34mm 1.3in +2.3= 3.66in wire 3.75in  
 wire T127 ( 65, 68) pad 11 distance 39mm 1.6in +2.3= 3.87in wire 4.00in  
 wire U136 ( 80, 51) pad 12 distance 36mm 1.4in +2.3= 3.75in wire 3.75in  
 wire T126 ( 82, 67) pad 13 distance 37mm 1.4in +2.3= 3.77in wire 4.00in  
 wire V135 ( 89, 37) pad 14 distance 33mm 1.3in +2.3= 3.63in wire 3.75in  
 wire U135 ( 97, 51) pad 15 distance 46mm 1.8in +2.3= 4.14in wire 4.50in  
 wire V134 (106, 38) pad 16 distance 34mm 1.4in +2.3= 3.67in wire 3.75in  
 wire T125 ( 99, 68) pad 17 distance 37mm 1.4in +2.3= 3.76in wire 4.00in  
 wire U134 (113, 52) pad 18 distance 38mm 1.5in +2.3= 3.81in wire 4.00in  
 wire T124 (116, 68) pad 19 distance 39mm 1.5in +2.3= 3.86in wire 4.00in  
 wire V133 (122, 39) pad 20 distance 37mm 1.5in +2.3= 3.77in wire 4.00in  
 wire T123 (133, 70) pad 21 distance 44mm 1.7in +2.3= 4.04in wire 4.50in  
 wire U133 (129, 54) pad 22 distance 40mm 1.6in +2.3= 3.90in wire 4.00in  
 wire U132 (146, 56) pad 23 distance 54mm 2.1in +2.3= 4.45in wire 4.50in

Longest wire U132 at 113.0mm 4.45in Mean dist 98.1mm 3.86in

5 3.75-inch wires 15 4-inch wires 4 4.5-inch wires 0 5-inch wires 0 longer wires

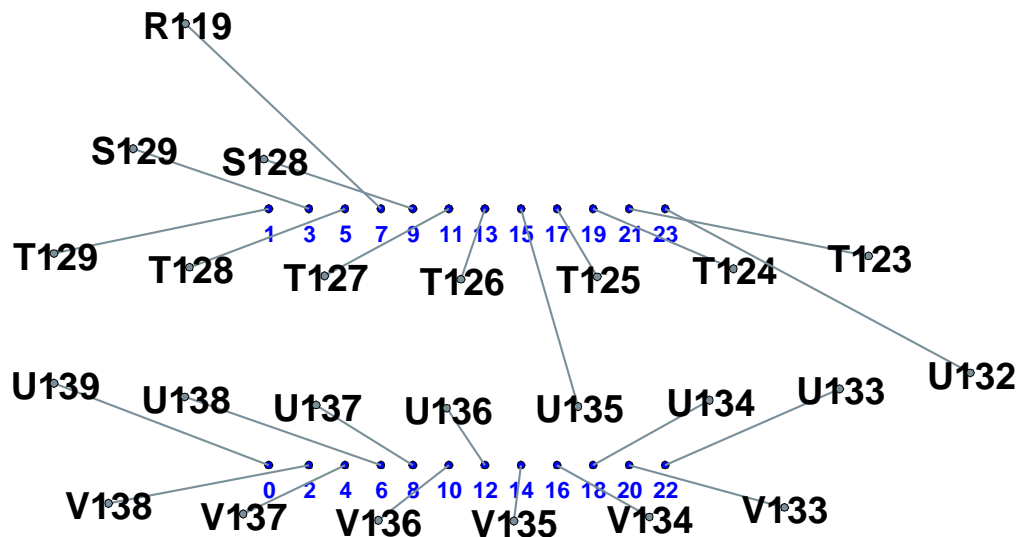



## G19

wire U147 ( 31, 55) pad 0 distance 43mm 1.7in +2.3= 4.02in wire 4.50in  
 wire U148 ( 15, 57) pad 1 distance 56mm 2.2in +2.3= 4.51in wire 5.00in  
 wire V146 ( 38, 40) pad 2 distance 39mm 1.5in +2.3= 3.87in wire 4.00in  
 wire T137 ( 22, 73) pad 3 distance 51mm 2.0in +2.3= 4.31in wire 4.50in  
 wire V145 ( 54, 38) pad 4 distance 34mm 1.4in +2.3= 3.67in wire 3.75in  
 wire T136 ( 39, 70) pad 5 distance 43mm 1.7in +2.3= 4.02in wire 4.50in  
 wire U146 ( 47, 53) pad 6 distance 40mm 1.6in +2.3= 3.89in wire 4.00in  
 wire T135 ( 56, 68) pad 7 distance 38mm 1.5in +2.3= 3.84in wire 4.00in  
 wire V144 ( 71, 37) pad 8 distance 33mm 1.3in +2.3= 3.63in wire 3.75in  
 wire U145 ( 64, 52) pad 9 distance 47mm 1.8in +2.3= 4.17in wire 4.50in  
 wire U144 ( 80, 51) pad 10 distance 36mm 1.4in +2.3= 3.73in wire 3.75in  
 wire T134 ( 73, 67) pad 11 distance 37mm 1.5in +2.3= 3.79in wire 4.00in  
 wire V143 ( 88, 37) pad 12 distance 33mm 1.3in +2.3= 3.63in wire 3.75in  
 wire U143 ( 96, 51) pad 14 distance 36mm 1.4in +2.3= 3.75in wire 3.75in  
 wire T133 ( 90, 67) pad 15 distance 37mm 1.4in +2.3= 3.77in wire 4.00in  
 wire V142 (105, 37) pad 16 distance 34mm 1.3in +2.3= 3.67in wire 3.75in  
 wire T132 (107, 67) pad 17 distance 38mm 1.5in +2.3= 3.82in wire 4.00in  
 wire U142 (113, 51) pad 18 distance 38mm 1.5in +2.3= 3.80in wire 4.00in  
 wire T131 (124, 68) pad 19 distance 43mm 1.7in +2.3= 4.00in wire 4.00in  
 wire W151 (123, 22) pad 20 distance 40mm 1.6in +2.3= 3.91in wire 4.00in  
 wire U141 (129, 53) pad 21 distance 50mm 1.9in +2.3= 4.27in wire 4.50in  
 wire V141 (122, 38) pad 22 distance 35mm 1.4in +2.3= 3.68in wire 3.75in  
 wire T130 (140, 70) pad 23 distance 45mm 1.8in +2.3= 4.10in wire 4.50in

Longest wire U148 at 114.6mm 4.51in Mean dist 99.2mm 3.91in

7 3.75-inch wires 9 4-inch wires 6 4.5-inch wires 1 5-inch wires 0 longer wires

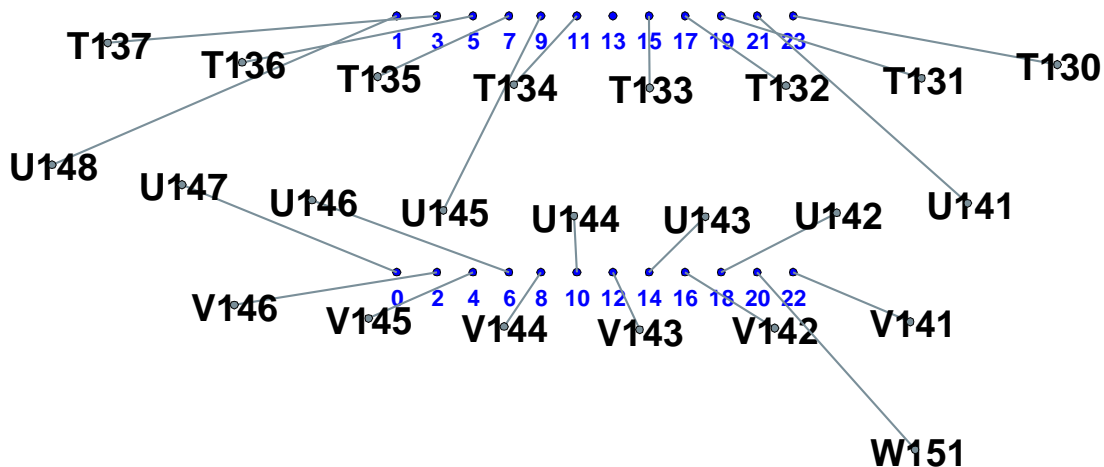

## G20

wire V156 ( 27, 37) pad 0 distance 43mm 1.7in +2.3= 4.01in wire 4.50in  
 wire U157 ( 20, 52) pad 1 distance 55mm 2.2in +2.3= 4.49in wire 4.50in  
 wire U156 ( 36, 50) pad 2 distance 42mm 1.7in +2.3= 3.98in wire 4.00in  
 wire S146 ( 25, 82) pad 3 distance 47mm 1.9in +2.3= 4.19in wire 4.50in  
 wire V155 ( 44, 36) pad 4 distance 39mm 1.5in +2.3= 3.86in wire 4.00in  
 wire T145 ( 32, 67) pad 5 distance 48mm 1.9in +2.3= 4.23in wire 4.50in  
 wire U155 ( 52, 49) pad 6 distance 37mm 1.5in +2.3= 3.78in wire 4.00in  
 wire T144 ( 49, 66) pad 7 distance 42mm 1.7in +2.3= 3.99in wire 4.00in  
 wire V154 ( 60, 35) pad 8 distance 36mm 1.4in +2.3= 3.75in wire 3.75in  
 wire T143 ( 66, 65) pad 9 distance 39mm 1.5in +2.3= 3.84in wire 4.00in  
 wire V153 ( 77, 35) pad 10 distance 33mm 1.3in +2.3= 3.63in wire 3.75in  
 wire U154 ( 69, 49) pad 11 distance 49mm 1.9in +2.3= 4.24in wire 4.50in  
 wire U153 ( 85, 49) pad 12 distance 35mm 1.4in +2.3= 3.71in wire 3.75in  
 wire T142 ( 83, 65) pad 13 distance 37mm 1.5in +2.3= 3.80in wire 4.00in  
 wire V152 ( 94, 36) pad 14 distance 33mm 1.3in +2.3= 3.63in wire 3.75in  
 wire T141 (100, 66) pad 15 distance 38mm 1.5in +2.3= 3.83in wire 4.00in  
 wire U152 (102, 50) pad 16 distance 36mm 1.4in +2.3= 3.74in wire 3.75in  
 wire T140 (117, 68) pad 17 distance 42mm 1.6in +2.3= 3.97in wire 4.00in  
 wire V151 (111, 37) pad 18 distance 35mm 1.4in +2.3= 3.68in wire 3.75in  
 wire U151 (118, 52) pad 19 distance 48mm 1.9in +2.3= 4.23in wire 4.50in  
 wire V150 (128, 39) pad 20 distance 40mm 1.6in +2.3= 3.88in wire 4.00in  
 wire T139 (134, 70) pad 21 distance 44mm 1.7in +2.3= 4.06in wire 4.50in  
 wire U150 (134, 54) pad 22 distance 42mm 1.7in +2.3= 3.99in wire 4.00in  
 wire U149 (150, 57) pad 23 distance 57mm 2.2in +2.3= 4.55in wire 5.00in

Longest wire U149 at 115.6mm 4.55in Mean dist 100.6mm 3.96in

6 3.75-inch wires 10 4-inch wires 7 4.5-inch wires 1 5-inch wires 0 longer wires

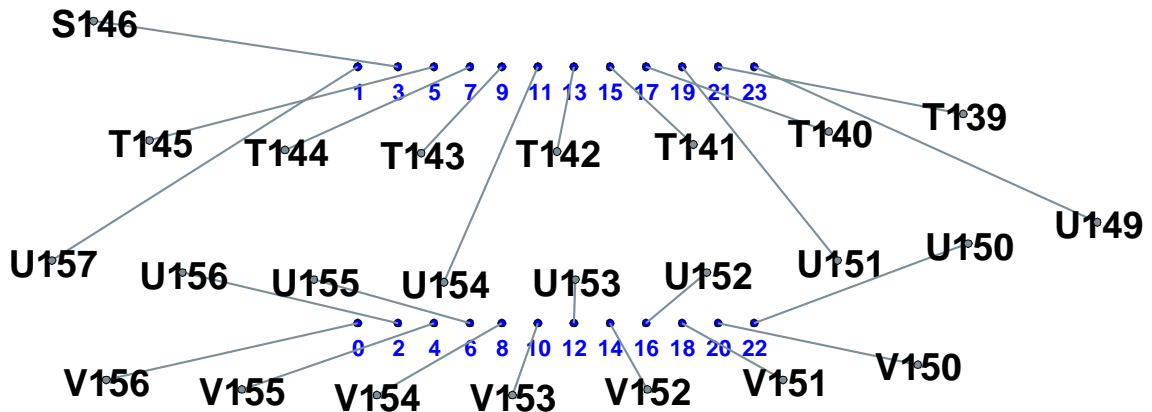

## G21

wire V164 ( 37, 37) pad 0 distance 37mm 1.5in +2.3= 3.79in wire 4.00in  
 wire U165 ( 30, 52) pad 1 distance 50mm 2.0in +2.3= 4.28in wire 4.50in  
 wire V163 ( 54, 36) pad 2 distance 33mm 1.3in +2.3= 3.64in wire 3.75in  
 wire T153 ( 32, 68) pad 3 distance 45mm 1.8in +2.3= 4.09in wire 4.50in  
 wire W174 ( 62, 20) pad 4 distance 38mm 1.5in +2.3= 3.81in wire 4.00in  
 wire U164 ( 46, 51) pad 5 distance 49mm 1.9in +2.3= 4.25in wire 4.50in  
 wire U163 ( 62, 50) pad 6 distance 34mm 1.3in +2.3= 3.65in wire 3.75in  
 wire T152 ( 49, 67) pad 7 distance 42mm 1.6in +2.3= 3.97in wire 4.00in  
 wire V162 ( 70, 36) pad 8 distance 33mm 1.3in +2.3= 3.64in wire 3.75in  
 wire T151 ( 66, 66) pad 9 distance 38mm 1.5in +2.3= 3.82in wire 4.00in  
 wire W173 ( 78, 20) pad 10 distance 37mm 1.5in +2.3= 3.79in wire 4.00in  
 wire U162 ( 79, 50) pad 11 distance 47mm 1.8in +2.3= 4.16in wire 4.50in  
 wire V161 ( 87, 36) pad 12 distance 33mm 1.3in +2.3= 3.63in wire 3.75in  
 wire T150 ( 83, 66) pad 13 distance 37mm 1.5in +2.3= 3.78in wire 4.00in  
 wire U161 ( 95, 51) pad 14 distance 36mm 1.4in +2.3= 3.74in wire 3.75in  
 wire T149 (100, 67) pad 15 distance 38mm 1.5in +2.3= 3.81in wire 4.00in  
 wire V160 (104, 37) pad 16 distance 34mm 1.3in +2.3= 3.66in wire 3.75in  
 wire T148 (117, 69) pad 17 distance 42mm 1.6in +2.3= 3.96in wire 4.00in  
 wire U160 (111, 52) pad 18 distance 37mm 1.5in +2.3= 3.79in wire 4.00in  
 wire U159 (128, 54) pad 19 distance 52mm 2.0in +2.3= 4.35in wire 4.50in  
 wire V159 (121, 39) pad 20 distance 36mm 1.4in +2.3= 3.75in wire 4.00in  
 wire T147 (134, 71) pad 21 distance 44mm 1.7in +2.3= 4.05in wire 4.50in  
 wire U158 (144, 56) pad 22 distance 49mm 1.9in +2.3= 4.25in wire 4.50in  
 wire T146 (150, 74) pad 23 distance 51mm 2.0in +2.3= 4.34in wire 4.50in

Longest wire U159 at 110.6mm 4.35in Mean dist 99.5mm 3.92in

6 3.75-inch wires 10 4-inch wires 8 4.5-inch wires 0 5-inch wires 0 longer wires

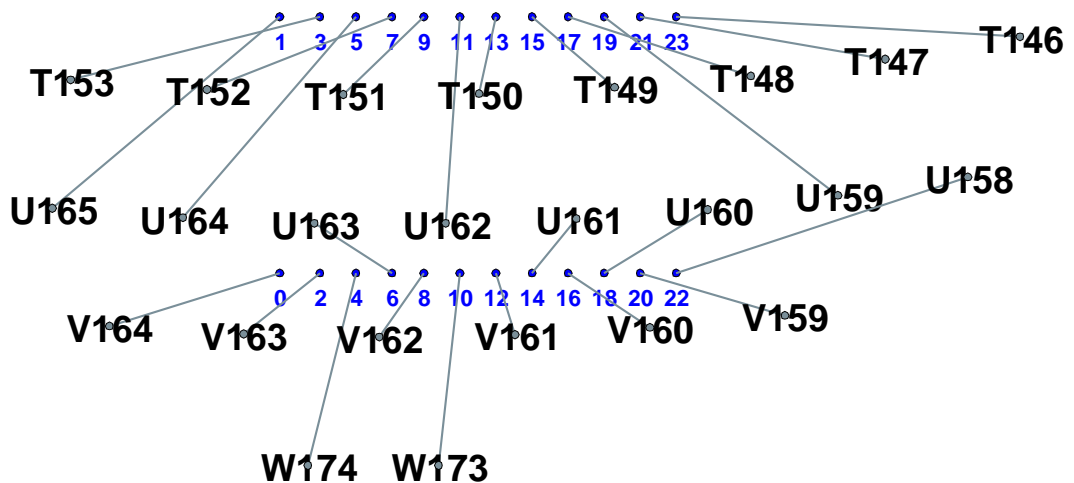

# H1

wire Y7 ( 26, 41) pad 0 distance 43mm 1.7in +2.3= 4.02in wire 4.50in  
wire X7 ( 31, 57) pad 1 distance 47mm 1.8in +2.3= 4.15in wire 4.50in  
wire Y6 ( 42, 39) pad 2 distance 37mm 1.5in +2.3= 3.78in wire 4.00in  
wire W6 ( 41, 70) pad 3 distance 40mm 1.6in +2.3= 3.88in wire 4.00in  
wire Z6 ( 49, 24) pad 4 distance 39mm 1.5in +2.3= 3.84in wire 4.00in  
wire X6 ( 48, 54) pad 5 distance 46mm 1.8in +2.3= 4.13in wire 4.50in  
wire X5 ( 64, 53) pad 6 distance 34mm 1.3in +2.3= 3.65in wire 3.75in  
wire W5 ( 58, 68) pad 7 distance 38mm 1.5in +2.3= 3.83in wire 4.00in  
wire Y5 ( 58, 37) pad 8 distance 37mm 1.5in +2.3= 3.78in wire 4.00in  
wire V4 ( 70, 83) pad 9 distance 33mm 1.3in +2.3= 3.64in wire 3.75in  
wire Z5 ( 66, 23) pad 10 distance 39mm 1.5in +2.3= 3.85in wire 4.00in  
wire W4 ( 74, 66) pad 11 distance 38mm 1.5in +2.3= 3.80in wire 4.00in  
wire Y4 ( 74, 36) pad 12 distance 35mm 1.4in +2.3= 3.69in wire 3.75in  
wire X4 ( 81, 52) pad 13 distance 46mm 1.8in +2.3= 4.12in wire 4.50in  
wire Z4 ( 82, 22) pad 14 distance 37mm 1.5in +2.3= 3.80in wire 4.00in  
wire V3 ( 87, 82) pad 15 distance 33mm 1.3in +2.3= 3.63in wire 3.75in  
wire Y3 ( 90, 35) pad 16 distance 34mm 1.3in +2.3= 3.64in wire 3.75in  
wire W3 ( 90, 65) pad 17 distance 38mm 1.5in +2.3= 3.81in wire 4.00in  
wire X3 ( 98, 51) pad 18 distance 36mm 1.4in +2.3= 3.73in wire 3.75in  
wire W2 (106, 65) pad 19 distance 38mm 1.5in +2.3= 3.81in wire 4.00in  
wire Y2 (107, 35) pad 20 distance 33mm 1.3in +2.3= 3.63in wire 3.75in  
wire X2 (115, 51) pad 21 distance 46mm 1.8in +2.3= 4.13in wire 4.50in  
wire Y1 (123, 35) pad 22 distance 35mm 1.4in +2.3= 3.69in wire 3.75in  
wire X1 (132, 52) pad 23 distance 49mm 1.9in +2.3= 4.25in wire 4.50in

Longest wire X1 at 107.9mm 4.25in Mean dist 97.6mm 3.84in

8 3.75-inch wires 10 4-inch wires 6 4.5-inch wires 0 5-inch wires 0 longer wires

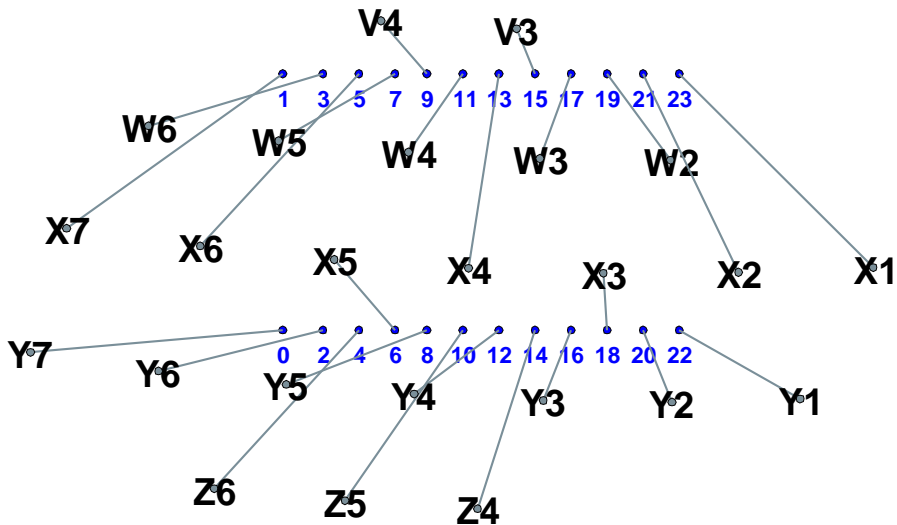

## H2

wire X15 ( 31, 57) pad 0 distance 44mm 1.7in +2.3= 4.05in wire 4.50in  
 wire X16 ( 14, 60) pad 1 distance 55mm 2.2in +2.3= 4.49in wire 4.50in  
 wire Y15 ( 37, 40) pad 2 distance 40mm 1.6in +2.3= 3.88in wire 4.00in  
 wire W14 ( 41, 70) pad 3 distance 39mm 1.6in +2.3= 3.88in wire 4.00in  
 wire Y14 ( 53, 38) pad 4 distance 35mm 1.4in +2.3= 3.69in wire 3.75in  
 wire X14 ( 48, 54) pad 5 distance 46mm 1.8in +2.3= 4.13in wire 4.50in  
 wire X13 ( 65, 53) pad 6 distance 34mm 1.3in +2.3= 3.65in wire 3.75in  
 wire W13 ( 58, 68) pad 7 distance 38mm 1.5in +2.3= 3.83in wire 4.00in  
 wire Y13 ( 69, 36) pad 8 distance 34mm 1.3in +2.3= 3.64in wire 3.75in  
 wire V12 ( 62, 83) pad 9 distance 36mm 1.4in +2.3= 3.73in wire 3.75in  
 wire Z13 ( 77, 22) pad 10 distance 36mm 1.4in +2.3= 3.76in wire 4.00in  
 wire W12 ( 74, 66) pad 11 distance 38mm 1.5in +2.3= 3.80in wire 4.00in  
 wire X12 ( 81, 52) pad 12 distance 36mm 1.4in +2.3= 3.75in wire 4.00in  
 wire V11 ( 78, 82) pad 13 distance 34mm 1.3in +2.3= 3.65in wire 3.75in  
 wire Y12 ( 85, 36) pad 14 distance 34mm 1.3in +2.3= 3.64in wire 3.75in  
 wire W11 ( 90, 66) pad 15 distance 37mm 1.5in +2.3= 3.79in wire 4.00in  
 wire Z12 ( 93, 21) pad 16 distance 37mm 1.4in +2.3= 3.76in wire 4.00in  
 wire V10 ( 95, 81) pad 17 distance 33mm 1.3in +2.3= 3.62in wire 3.75in  
 wire Y11 (101, 35) pad 18 distance 33mm 1.3in +2.3= 3.63in wire 3.75in  
 wire X11 ( 98, 51) pad 19 distance 46mm 1.8in +2.3= 4.13in wire 4.50in  
 wire Y10 (117, 35) pad 20 distance 35mm 1.4in +2.3= 3.70in wire 3.75in  
 wire W10 (107, 65) pad 21 distance 37mm 1.5in +2.3= 3.78in wire 4.00in  
 wire X10 (115, 51) pad 22 distance 35mm 1.4in +2.3= 3.71in wire 3.75in  
 wire X9 (132, 52) pad 23 distance 49mm 1.9in +2.3= 4.25in wire 4.50in

Longest wire X16 at 114.0mm 4.49in Mean dist 97.3mm 3.83in

10 3.75-inch wires 9 4-inch wires 5 4.5-inch wires 0 5-inch wires 0 longer wires

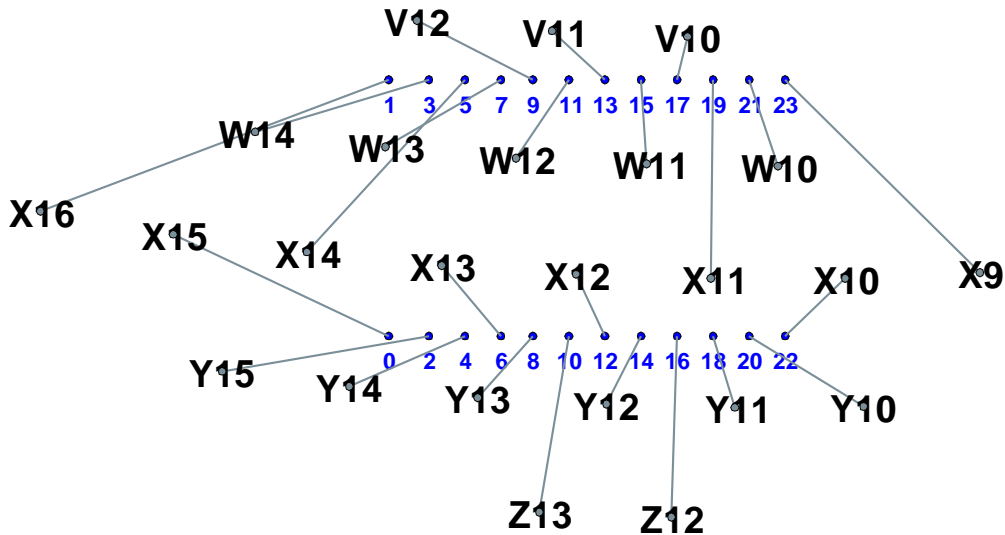

### H3

wire X22 ( 48, 54) pad 0 distance 37mm 1.5in +2.3= 3.78in wire 4.00in  
 wire X23 ( 31, 57) pad 1 distance 47mm 1.8in +2.3= 4.16in wire 4.50in  
 wire Y23 ( 48, 38) pad 2 distance 35mm 1.4in +2.3= 3.70in wire 3.75in  
 wire W22 ( 41, 69) pad 3 distance 40mm 1.6in +2.3= 3.88in wire 4.00in  
 wire Y22 ( 64, 37) pad 4 distance 33mm 1.3in +2.3= 3.62in wire 3.75in  
 wire V20 ( 52, 84) pad 5 distance 35mm 1.4in +2.3= 3.70in wire 3.75in  
 wire X21 ( 64, 53) pad 6 distance 34mm 1.3in +2.3= 3.65in wire 3.75in  
 wire W21 ( 58, 68) pad 7 distance 38mm 1.5in +2.3= 3.83in wire 4.00in  
 wire Y21 ( 80, 36) pad 8 distance 33mm 1.3in +2.3= 3.64in wire 3.75in  
 wire V19 ( 69, 83) pad 9 distance 33mm 1.3in +2.3= 3.64in wire 3.75in  
 wire X20 ( 81, 52) pad 10 distance 36mm 1.4in +2.3= 3.75in wire 3.75in  
 wire W20 ( 74, 66) pad 11 distance 38mm 1.5in +2.3= 3.80in wire 4.00in  
 wire Z21 ( 88, 22) pad 12 distance 37mm 1.4in +2.3= 3.76in wire 4.00in  
 wire V18 ( 86, 82) pad 13 distance 33mm 1.3in +2.3= 3.62in wire 3.75in  
 wire Y20 ( 96, 35) pad 14 distance 33mm 1.3in +2.3= 3.64in wire 3.75in  
 wire W19 ( 90, 66) pad 15 distance 37mm 1.5in +2.3= 3.79in wire 4.00in  
 wire Z20 (104, 21) pad 16 distance 37mm 1.5in +2.3= 3.80in wire 4.00in  
 wire X19 ( 98, 51) pad 17 distance 46mm 1.8in +2.3= 4.13in wire 4.50in  
 wire Y19 (112, 35) pad 18 distance 35mm 1.4in +2.3= 3.69in wire 3.75in  
 wire W18 (106, 65) pad 19 distance 38mm 1.5in +2.3= 3.81in wire 4.00in  
 wire X18 (115, 51) pad 20 distance 37mm 1.4in +2.3= 3.77in wire 4.00in  
 wire W17 (123, 66) pad 21 distance 40mm 1.6in +2.3= 3.90in wire 4.00in  
 wire Y18 (128, 36) pad 22 distance 37mm 1.4in +2.3= 3.77in wire 4.00in  
 wire X17 (132, 52) pad 23 distance 49mm 1.9in +2.3= 4.24in wire 4.50in

Longest wire X17 at 107.7mm 4.24in Mean dist 96.4mm 3.79in

10 3.75-inch wires 11 4-inch wires 3 4.5-inch wires 0 5-inch wires 0 longer wires

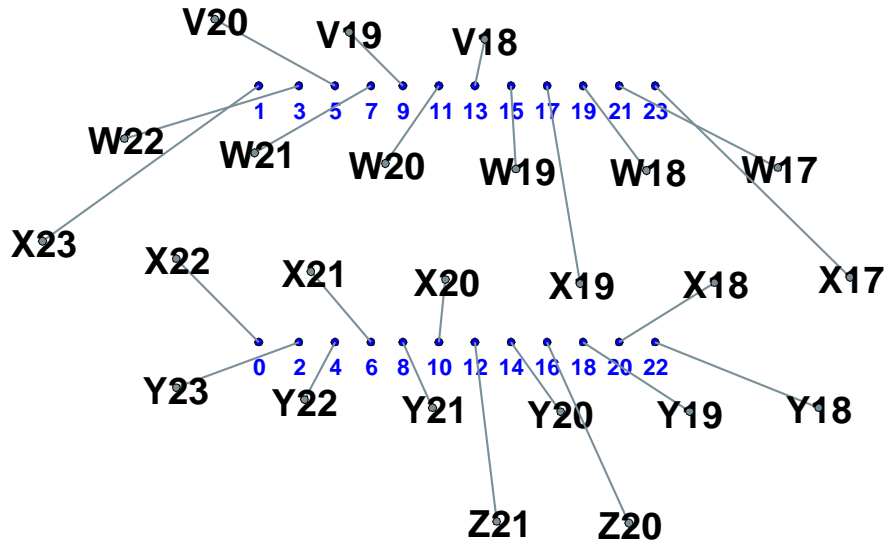

# H4

wire X31 ( 14, 60) pad 0 distance 55mm 2.2in +2.3= 4.51in wire 5.00in  
wire W30 ( 25, 72) pad 1 distance 44mm 1.7in +2.3= 4.06in wire 4.50in  
wire Y31 ( 41, 39) pad 2 distance 38mm 1.5in +2.3= 3.81in wire 4.00in  
wire X30 ( 31, 57) pad 3 distance 50mm 2.0in +2.3= 4.29in wire 4.50in  
wire Y30 ( 57, 37) pad 4 distance 34mm 1.3in +2.3= 3.65in wire 3.75in  
wire W29 ( 41, 70) pad 5 distance 42mm 1.7in +2.3= 3.97in wire 4.00in  
wire X29 ( 48, 54) pad 6 distance 40mm 1.6in +2.3= 3.89in wire 4.00in  
wire V27 ( 45, 85) pad 7 distance 41mm 1.6in +2.3= 3.93in wire 4.00in  
wire X28 ( 64, 53) pad 8 distance 38mm 1.5in +2.3= 3.82in wire 4.00in  
wire W28 ( 58, 68) pad 9 distance 40mm 1.6in +2.3= 3.91in wire 4.00in  
wire Y29 ( 73, 36) pad 10 distance 34mm 1.3in +2.3= 3.65in wire 3.75in  
wire W27 ( 74, 66) pad 11 distance 38mm 1.5in +2.3= 3.80in wire 4.00in  
wire Y28 ( 89, 35) pad 12 distance 33mm 1.3in +2.3= 3.63in wire 3.75in  
wire X27 ( 81, 52) pad 13 distance 46mm 1.8in +2.3= 4.12in wire 4.50in  
wire Z28 ( 97, 21) pad 14 distance 37mm 1.5in +2.3= 3.78in wire 4.00in  
wire W26 ( 90, 65) pad 15 distance 37mm 1.5in +2.3= 3.80in wire 4.00in  
wire X26 ( 98, 51) pad 16 distance 36mm 1.4in +2.3= 3.74in wire 3.75in  
wire Y27 (105, 35) pad 18 distance 33mm 1.3in +2.3= 3.64in wire 3.75in  
wire W25 (106, 65) pad 19 distance 38mm 1.5in +2.3= 3.81in wire 4.00in  
wire X25 (115, 51) pad 20 distance 37mm 1.4in +2.3= 3.77in wire 4.00in  
wire W24 (123, 66) pad 21 distance 40mm 1.6in +2.3= 3.90in wire 4.00in  
wire Y26 (121, 35) pad 22 distance 34mm 1.4in +2.3= 3.68in wire 3.75in  
wire X24 (132, 52) pad 23 distance 49mm 1.9in +2.3= 4.25in wire 4.50in

Longest wire X31 at 114.4mm 4.51in Mean dist 98.7mm 3.89in

6 3.75-inch wires 12 4-inch wires 4 4.5-inch wires 1 5-inch wires 0 longer wires

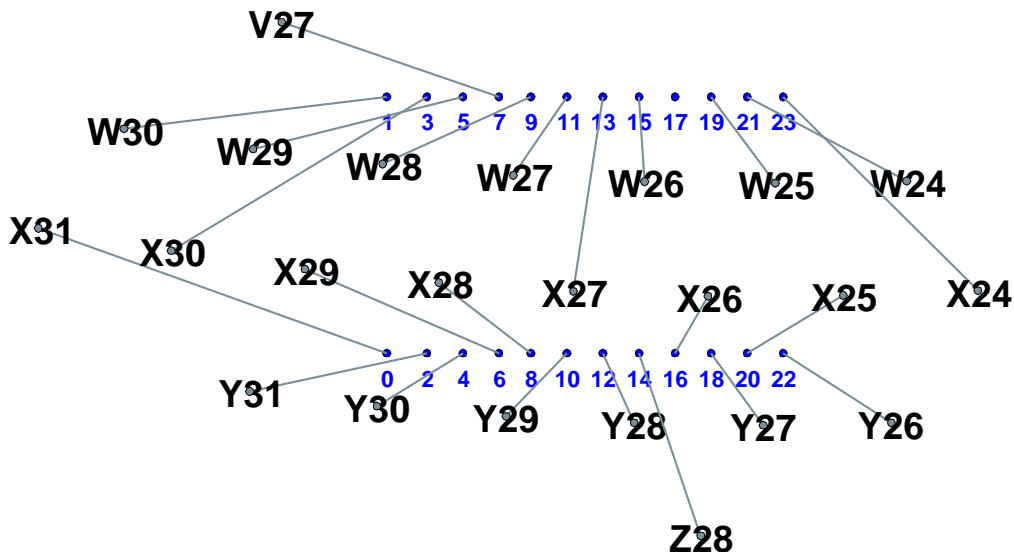

## H5

wire Y41 ( 19, 42) pad 0 distance 48mm 1.9in +2.3= 4.21in wire 4.50in  
 wire W38 ( 25, 72) pad 1 distance 45mm 1.8in +2.3= 4.08in wire 4.50in  
 wire Y40 ( 35, 40) pad 2 distance 41mm 1.6in +2.3= 3.93in wire 4.00in  
 wire X38 ( 31, 56) pad 3 distance 50mm 2.0in +2.3= 4.31in wire 4.50in  
 wire Y39 ( 51, 38) pad 4 distance 35mm 1.4in +2.3= 3.72in wire 3.75in  
 wire V35 ( 35, 86) pad 5 distance 44mm 1.7in +2.3= 4.05in wire 4.50in  
 wire X37 ( 47, 54) pad 6 distance 40mm 1.6in +2.3= 3.90in wire 4.00in  
 wire W37 ( 41, 69) pad 7 distance 46mm 1.8in +2.3= 4.11in wire 4.50in  
 wire X36 ( 64, 53) pad 8 distance 38mm 1.5in +2.3= 3.82in wire 4.00in  
 wire W36 ( 57, 68) pad 9 distance 41mm 1.6in +2.3= 3.92in wire 4.00in  
 wire Y38 ( 67, 36) pad 10 distance 35mm 1.4in +2.3= 3.72in wire 3.75in  
 wire W35 ( 73, 66) pad 11 distance 38mm 1.5in +2.3= 3.80in wire 4.00in  
 wire Y37 ( 83, 36) pad 12 distance 33mm 1.3in +2.3= 3.63in wire 3.75in  
 wire X35 ( 81, 52) pad 13 distance 46mm 1.8in +2.3= 4.12in wire 4.50in  
 wire X34 ( 98, 51) pad 14 distance 37mm 1.4in +2.3= 3.76in wire 4.00in  
 wire W34 ( 90, 66) pad 15 distance 37mm 1.5in +2.3= 3.79in wire 4.00in  
 wire Y36 ( 99, 35) pad 16 distance 33mm 1.3in +2.3= 3.63in wire 3.75in  
 wire W33 (106, 65) pad 17 distance 39mm 1.5in +2.3= 3.85in wire 4.00in  
 wire X33 (115, 51) pad 18 distance 38mm 1.5in +2.3= 3.82in wire 4.00in  
 wire W32 (122, 66) pad 19 distance 43mm 1.7in +2.3= 4.01in wire 4.50in  
 wire Y35 (115, 35) pad 20 distance 34mm 1.4in +2.3= 3.68in wire 3.75in  
 wire X32 (131, 52) pad 21 distance 51mm 2.0in +2.3= 4.32in wire 4.50in  
 wire Y34 (131, 36) pad 22 distance 38mm 1.5in +2.3= 3.83in wire 4.00in  
 wire W31 (139, 67) pad 23 distance 45mm 1.8in +2.3= 4.10in wire 4.50in

Longest wire X32 at 109.7mm 4.32in Mean dist 99.6mm 3.92in

5 3.75-inch wires 10 4-inch wires 9 4.5-inch wires 0 5-inch wires 0 longer wires

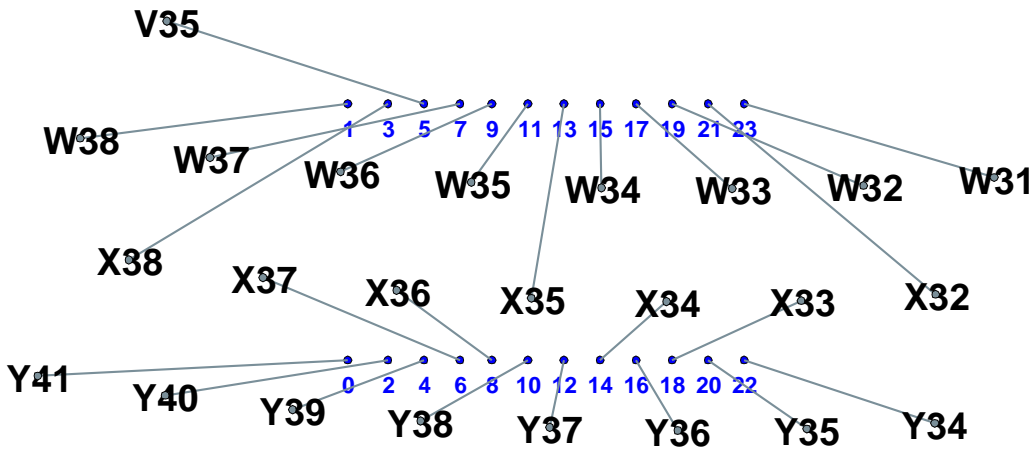



## H6

wire X45 ( 31, 57) pad 0 distance 44mm 1.7in +2.3= 4.05in wire 4.50in  
 wire X46 ( 14, 59) pad 1 distance 55mm 2.2in +2.3= 4.49in wire 4.50in  
 wire Y48 ( 29, 41) pad 2 distance 45mm 1.8in +2.3= 4.08in wire 4.50in  
 wire W45 ( 25, 72) pad 3 distance 48mm 1.9in +2.3= 4.23in wire 4.50in  
 wire Y47 ( 45, 39) pad 4 distance 38mm 1.5in +2.3= 3.83in wire 4.00in  
 wire W44 ( 41, 70) pad 5 distance 42mm 1.7in +2.3= 3.97in wire 4.00in  
 wire X43 ( 65, 53) pad 6 distance 34mm 1.3in +2.3= 3.65in wire 3.75in  
 wire X44 ( 48, 54) pad 7 distance 48mm 1.9in +2.3= 4.23in wire 4.50in  
 wire Y46 ( 61, 37) pad 8 distance 36mm 1.4in +2.3= 3.74in wire 3.75in  
 wire W43 ( 58, 68) pad 9 distance 40mm 1.6in +2.3= 3.91in wire 4.00in  
 wire Y45 ( 77, 36) pad 10 distance 33mm 1.3in +2.3= 3.63in wire 3.75in  
 wire W42 ( 74, 66) pad 11 distance 37mm 1.5in +2.3= 3.80in wire 4.00in  
 wire Y44 ( 93, 36) pad 12 distance 34mm 1.3in +2.3= 3.66in wire 3.75in  
 wire X42 ( 81, 52) pad 13 distance 45mm 1.8in +2.3= 4.11in wire 4.50in  
 wire X41 ( 98, 52) pad 14 distance 37mm 1.4in +2.3= 3.77in wire 4.00in  
 wire W41 ( 90, 66) pad 15 distance 37mm 1.5in +2.3= 3.79in wire 4.00in  
 wire Y43 (109, 36) pad 16 distance 36mm 1.4in +2.3= 3.72in wire 3.75in  
 wire W40 (106, 66) pad 17 distance 39mm 1.5in +2.3= 3.85in wire 4.00in  
 wire X40 (115, 52) pad 18 distance 38mm 1.5in +2.3= 3.83in wire 4.00in  
 wire V37 (112, 82) pad 19 distance 35mm 1.4in +2.3= 3.70in wire 3.75in  
 wire Y42 (125, 36) pad 20 distance 38mm 1.5in +2.3= 3.82in wire 4.00in  
 wire W39 (123, 66) pad 21 distance 40mm 1.6in +2.3= 3.89in wire 4.00in  
 wire X39 (132, 52) pad 22 distance 41mm 1.6in +2.3= 3.93in wire 4.00in  
 wire V36 (129, 82) pad 23 distance 37mm 1.5in +2.3= 3.79in wire 4.00in

Longest wire X46 at 114.1mm 4.49in Mean dist 98.9mm 3.89in

6 3.75-inch wires 12 4-inch wires 6 4.5-inch wires 0 5-inch wires 0 longer wires

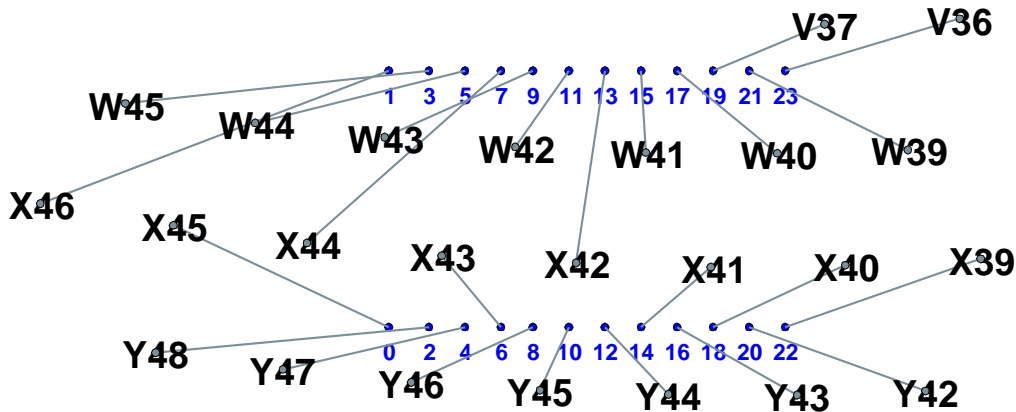

## H7

wire Y57 ( 24, 42) pad 0 distance 45mm 1.8in +2.3= 4.09in wire 4.50in  
 wire W53 ( 26, 72) pad 1 distance 44mm 1.7in +2.3= 4.05in wire 4.50in  
 wire Y56 ( 40, 40) pad 2 distance 38mm 1.5in +2.3= 3.83in wire 4.00in  
 wire X53 ( 31, 57) pad 3 distance 50mm 2.0in +2.3= 4.28in wire 4.50in  
 wire Y55 ( 56, 38) pad 4 distance 34mm 1.3in +2.3= 3.66in wire 3.75in  
 wire W52 ( 42, 70) pad 5 distance 42mm 1.6in +2.3= 3.97in wire 4.00in  
 wire X51 ( 65, 53) pad 6 distance 34mm 1.3in +2.3= 3.65in wire 3.75in  
 wire X52 ( 48, 55) pad 7 distance 48mm 1.9in +2.3= 4.23in wire 4.50in  
 wire Y54 ( 72, 36) pad 8 distance 33mm 1.3in +2.3= 3.63in wire 3.75in  
 wire W51 ( 58, 68) pad 9 distance 40mm 1.6in +2.3= 3.91in wire 4.00in  
 wire X50 ( 82, 52) pad 10 distance 36mm 1.4in +2.3= 3.75in wire 3.75in  
 wire W50 ( 74, 66) pad 11 distance 37mm 1.5in +2.3= 3.80in wire 4.00in  
 wire Y53 ( 88, 35) pad 12 distance 33mm 1.3in +2.3= 3.63in wire 3.75in  
 wire W49 ( 90, 66) pad 13 distance 38mm 1.5in +2.3= 3.81in wire 4.00in  
 wire Y52 (104, 35) pad 14 distance 35mm 1.4in +2.3= 3.72in wire 3.75in  
 wire X49 ( 98, 51) pad 15 distance 47mm 1.8in +2.3= 4.16in wire 4.50in  
 wire X48 (115, 51) pad 16 distance 41mm 1.6in +2.3= 3.93in wire 4.00in  
 wire W48 (107, 65) pad 17 distance 39mm 1.5in +2.3= 3.86in wire 4.00in  
 wire Y51 (120, 35) pad 18 distance 38mm 1.5in +2.3= 3.82in wire 4.00in  
 wire V44 (121, 82) pad 19 distance 39mm 1.5in +2.3= 3.84in wire 4.00in  
 wire X47 (132, 52) pad 20 distance 44mm 1.7in +2.3= 4.07in wire 4.50in  
 wire W47 (123, 66) pad 21 distance 40mm 1.6in +2.3= 3.91in wire 4.00in  
 wire Y50 (136, 36) pad 22 distance 41mm 1.6in +2.3= 3.93in wire 4.00in  
 wire W46 (140, 66) pad 23 distance 46mm 1.8in +2.3= 4.12in wire 4.50in

Longest wire X53 at 108.8mm 4.28in Mean dist 99.1mm 3.90in

6 3.75-inch wires 11 4-inch wires 7 4.5-inch wires 0 5-inch wires 0 longer wires

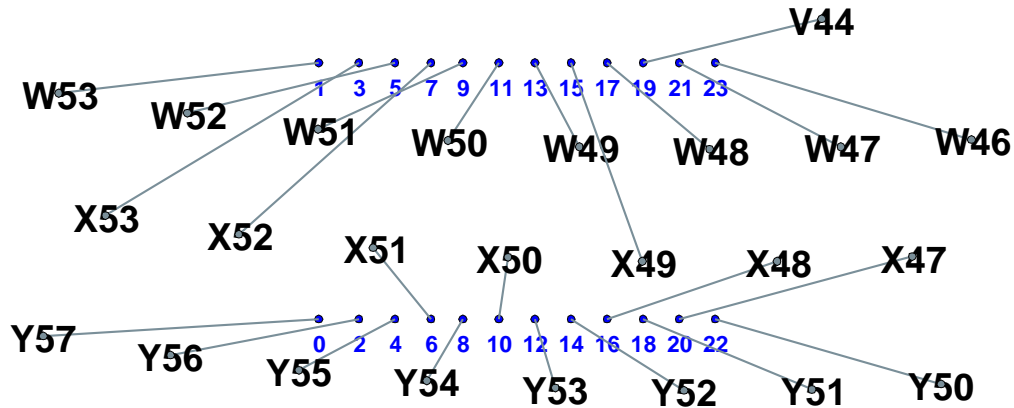

## H8

wire Y65 ( 34, 40) pad 0 distance 39mm 1.5in +2.3= 3.84in wire 4.00in  
 wire X61 ( 31, 57) pad 1 distance 46mm 1.8in +2.3= 4.15in wire 4.50in  
 wire Z65 ( 41, 25) pad 2 distance 40mm 1.6in +2.3= 3.89in wire 4.00in  
 wire W60 ( 42, 70) pad 3 distance 39mm 1.6in +2.3= 3.87in wire 4.00in  
 wire Y64 ( 50, 38) pad 4 distance 36mm 1.4in +2.3= 3.74in wire 3.75in  
 wire X60 ( 48, 54) pad 5 distance 46mm 1.8in +2.3= 4.13in wire 4.50in  
 wire X59 ( 65, 53) pad 6 distance 34mm 1.3in +2.3= 3.65in wire 3.75in  
 wire W59 ( 58, 68) pad 7 distance 38mm 1.5in +2.3= 3.82in wire 4.00in  
 wire Z64 ( 57, 23) pad 8 distance 40mm 1.6in +2.3= 3.90in wire 4.00in  
 wire W58 ( 74, 66) pad 9 distance 37mm 1.5in +2.3= 3.78in wire 4.00in  
 wire Y63 ( 66, 37) pad 10 distance 36mm 1.4in +2.3= 3.74in wire 3.75in  
 wire X58 ( 81, 52) pad 11 distance 46mm 1.8in +2.3= 4.11in wire 4.50in  
 wire Y62 ( 82, 36) pad 12 distance 33mm 1.3in +2.3= 3.63in wire 3.75in  
 wire W57 ( 90, 65) pad 13 distance 38mm 1.5in +2.3= 3.81in wire 4.00in  
 wire Y61 ( 98, 35) pad 14 distance 34mm 1.3in +2.3= 3.65in wire 3.75in  
 wire X57 ( 98, 51) pad 15 distance 47mm 1.8in +2.3= 4.16in wire 4.50in  
 wire Y60 (114, 35) pad 16 distance 38mm 1.5in +2.3= 3.80in wire 4.00in  
 wire W56 (107, 65) pad 17 distance 39mm 1.5in +2.3= 3.86in wire 4.00in  
 wire X56 (115, 51) pad 18 distance 38mm 1.5in +2.3= 3.83in wire 4.00in  
 wire V52 (112, 81) pad 19 distance 35mm 1.4in +2.3= 3.69in wire 3.75in  
 wire X55 (132, 52) pad 20 distance 44mm 1.7in +2.3= 4.06in wire 4.50in  
 wire W55 (123, 66) pad 21 distance 40mm 1.6in +2.3= 3.91in wire 4.00in  
 wire X54 (149, 53) pad 22 distance 51mm 2.0in +2.3= 4.34in wire 4.50in  
 wire W54 (139, 66) pad 23 distance 46mm 1.8in +2.3= 4.12in wire 4.50in

Longest wire X54 at 110.3mm 4.34in Mean dist 98.9mm 3.89in

6 3.75-inch wires 11 4-inch wires 7 4.5-inch wires 0 5-inch wires 0 longer wires

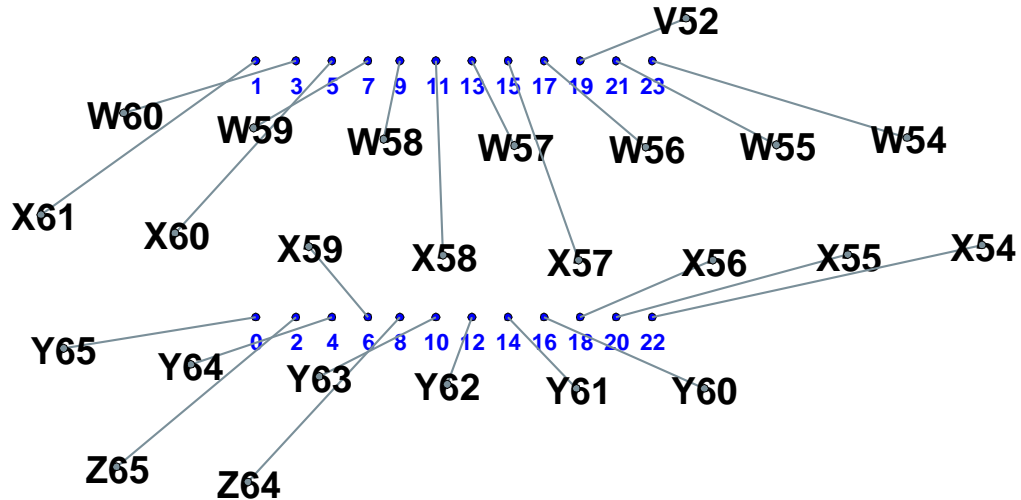

## H9

wire Y73 ( 27, 41) pad 0 distance 42mm 1.7in +2.3= 4.00in wire 4.00in  
 wire W68 ( 25, 72) pad 1 distance 44mm 1.7in +2.3= 4.06in wire 4.50in  
 wire Y72 ( 43, 39) pad 2 distance 37mm 1.4in +2.3= 3.76in wire 4.00in  
 wire X68 ( 31, 57) pad 3 distance 50mm 2.0in +2.3= 4.29in wire 4.50in  
 wire Z72 ( 50, 24) pad 4 distance 38mm 1.5in +2.3= 3.83in wire 4.00in  
 wire W67 ( 41, 70) pad 5 distance 42mm 1.6in +2.3= 3.97in wire 4.00in  
 wire X66 ( 65, 53) pad 6 distance 34mm 1.3in +2.3= 3.65in wire 3.75in  
 wire X67 ( 48, 54) pad 7 distance 48mm 1.9in +2.3= 4.23in wire 4.50in  
 wire Y71 ( 59, 37) pad 8 distance 37mm 1.4in +2.3= 3.76in wire 4.00in  
 wire W66 ( 58, 68) pad 9 distance 40mm 1.6in +2.3= 3.91in wire 4.00in  
 wire Z71 ( 67, 23) pad 10 distance 38mm 1.5in +2.3= 3.83in wire 4.00in  
 wire W65 ( 74, 66) pad 11 distance 37mm 1.5in +2.3= 3.80in wire 4.00in  
 wire Y70 ( 75, 36) pad 12 distance 34mm 1.4in +2.3= 3.68in wire 3.75in  
 wire X65 ( 82, 52) pad 13 distance 46mm 1.8in +2.3= 4.12in wire 4.50in  
 wire Y69 ( 91, 35) pad 14 distance 33mm 1.3in +2.3= 3.62in wire 3.75in  
 wire W64 ( 90, 66) pad 15 distance 37mm 1.5in +2.3= 3.79in wire 4.00in  
 wire X64 ( 98, 51) pad 16 distance 36mm 1.4in +2.3= 3.74in wire 3.75in  
 wire V59 (104, 82) pad 17 distance 34mm 1.3in +2.3= 3.66in wire 3.75in  
 wire Y68 (107, 35) pad 18 distance 34mm 1.3in +2.3= 3.65in wire 3.75in  
 wire W63 (107, 65) pad 19 distance 38mm 1.5in +2.3= 3.81in wire 4.00in  
 wire X63 (115, 51) pad 20 distance 37mm 1.4in +2.3= 3.77in wire 4.00in  
 wire W62 (123, 66) pad 21 distance 40mm 1.6in +2.3= 3.90in wire 4.00in  
 wire X62 (132, 52) pad 22 distance 41mm 1.6in +2.3= 3.93in wire 4.00in  
 wire W61 (139, 67) pad 23 distance 45mm 1.8in +2.3= 4.11in wire 4.50in

Longest wire X68 at 109.0mm 4.29in Mean dist 98.3mm 3.87in

6 3.75-inch wires 13 4-inch wires 5 4.5-inch wires 0 5-inch wires 0 longer wires

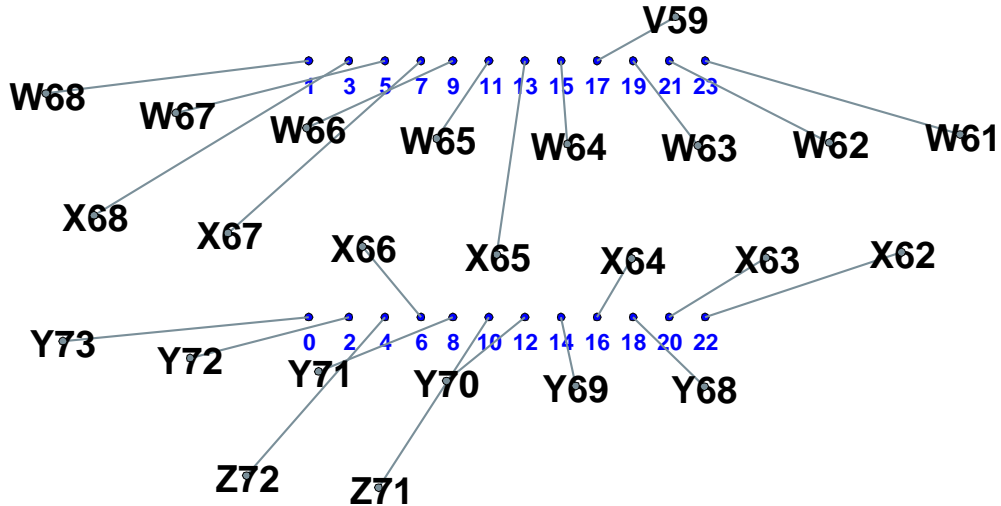

# H10

wire Y81 ( 21, 42) pad 0 distance 47mm 1.9in +2.3= 4.18in wire 4.50in  
 wire X76 ( 14, 60) pad 1 distance 55mm 2.2in +2.3= 4.49in wire 4.50in  
 wire Y80 ( 36, 40) pad 2 distance 40mm 1.6in +2.3= 3.90in wire 4.00in  
 wire W75 ( 25, 72) pad 3 distance 48mm 1.9in +2.3= 4.22in wire 4.50in  
 wire Z80 ( 43, 25) pad 4 distance 41mm 1.6in +2.3= 3.94in wire 4.00in  
 wire X75 ( 31, 57) pad 5 distance 53mm 2.1in +2.3= 4.41in wire 4.50in  
 wire X74 ( 48, 54) pad 6 distance 40mm 1.6in +2.3= 3.89in wire 4.00in  
 wire W74 ( 41, 70) pad 7 distance 45mm 1.8in +2.3= 4.10in wire 4.50in  
 wire Y79 ( 52, 38) pad 8 distance 40mm 1.6in +2.3= 3.90in wire 4.00in  
 wire W73 ( 58, 68) pad 9 distance 40mm 1.6in +2.3= 3.91in wire 4.00in  
 wire Z79 ( 60, 23) pad 10 distance 41mm 1.6in +2.3= 3.94in wire 4.00in  
 wire X73 ( 65, 53) pad 11 distance 47mm 1.9in +2.3= 4.18in wire 4.50in  
 wire Y78 ( 68, 36) pad 12 distance 37mm 1.5in +2.3= 3.78in wire 4.00in  
 wire W72 ( 74, 66) pad 13 distance 39mm 1.5in +2.3= 3.84in wire 4.00in  
 wire X72 ( 81, 52) pad 14 distance 37mm 1.5in +2.3= 3.80in wire 4.00in  
 wire V67 ( 79, 82) pad 15 distance 35mm 1.4in +2.3= 3.69in wire 3.75in  
 wire Y77 ( 84, 36) pad 16 distance 35mm 1.4in +2.3= 3.70in wire 3.75in  
 wire W71 ( 90, 66) pad 17 distance 38mm 1.5in +2.3= 3.81in wire 4.00in  
 wire Y76 (100, 35) pad 18 distance 33mm 1.3in +2.3= 3.63in wire 3.75in  
 wire X71 ( 98, 51) pad 19 distance 46mm 1.8in +2.3= 4.13in wire 4.50in  
 wire X70 (115, 52) pad 20 distance 37mm 1.4in +2.3= 3.77in wire 4.00in  
 wire W70 (106, 66) pad 21 distance 37mm 1.5in +2.3= 3.78in wire 4.00in  
 wire X69 (132, 52) pad 22 distance 41mm 1.6in +2.3= 3.93in wire 4.00in  
 wire W69 (123, 66) pad 23 distance 38mm 1.5in +2.3= 3.83in wire 4.00in

Longest wire X76 at 114.1mm 4.49in Mean dist 100.3mm 3.95in

3 3.75-inch wires 14 4-inch wires 7 4.5-inch wires 0 5-inch wires 0 longer wires

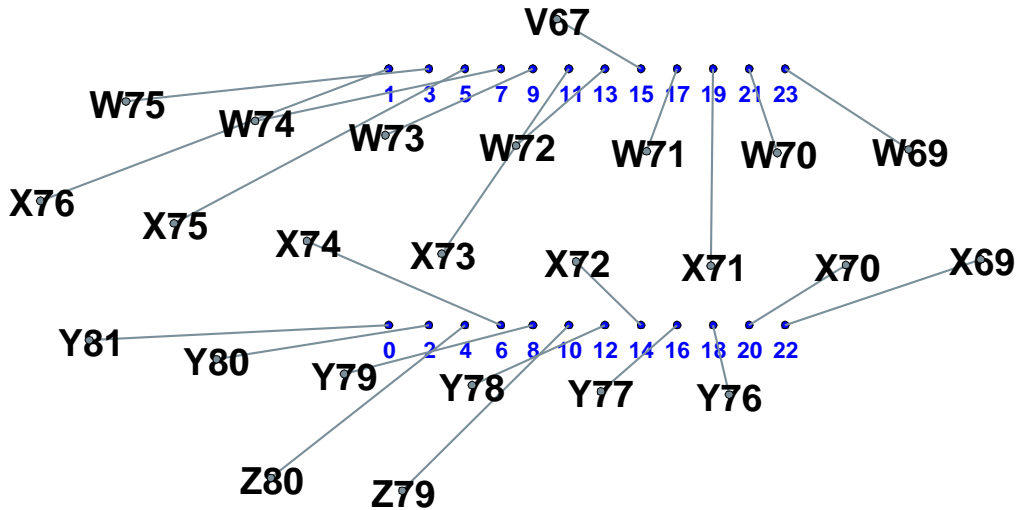

# H11

wire Y89 ( 31, 40) pad 0 distance 40mm 1.6in +2.3= 3.91in wire 4.00in  
 wire X83 ( 31, 57) pad 1 distance 47mm 1.8in +2.3= 4.15in wire 4.50in  
 wire Z89 ( 38, 26) pad 2 distance 41mm 1.6in +2.3= 3.95in wire 4.00in  
 wire W82 ( 41, 69) pad 3 distance 40mm 1.6in +2.3= 3.88in wire 4.00in  
 wire Z88 ( 54, 24) pad 4 distance 37mm 1.5in +2.3= 3.79in wire 4.00in  
 wire X82 ( 48, 54) pad 5 distance 46mm 1.8in +2.3= 4.13in wire 4.50in  
 wire Y88 ( 47, 38) pad 6 distance 41mm 1.6in +2.3= 3.93in wire 4.00in  
 wire W81 ( 58, 68) pad 7 distance 38mm 1.5in +2.3= 3.83in wire 4.00in  
 wire Y87 ( 63, 37) pad 8 distance 35mm 1.4in +2.3= 3.71in wire 3.75in  
 wire X81 ( 64, 53) pad 9 distance 46mm 1.8in +2.3= 4.13in wire 4.50in  
 wire Z87 ( 70, 22) pad 10 distance 37mm 1.5in +2.3= 3.79in wire 4.00in  
 wire V75 ( 70, 83) pad 11 distance 34mm 1.4in +2.3= 3.68in wire 3.75in  
 wire Y86 ( 79, 36) pad 12 distance 34mm 1.3in +2.3= 3.64in wire 3.75in  
 wire W80 ( 74, 66) pad 13 distance 39mm 1.5in +2.3= 3.84in wire 4.00in  
 wire X80 ( 81, 52) pad 14 distance 37mm 1.5in +2.3= 3.80in wire 4.00in  
 wire V74 ( 87, 82) pad 15 distance 33mm 1.3in +2.3= 3.63in wire 3.75in  
 wire Y85 ( 95, 35) pad 16 distance 33mm 1.3in +2.3= 3.62in wire 3.75in  
 wire W79 ( 90, 66) pad 17 distance 38mm 1.5in +2.3= 3.81in wire 4.00in  
 wire X79 ( 98, 51) pad 18 distance 36mm 1.4in +2.3= 3.73in wire 3.75in  
 wire W78 (106, 65) pad 19 distance 38mm 1.5in +2.3= 3.81in wire 4.00in  
 wire Y84 (111, 35) pad 20 distance 33mm 1.3in +2.3= 3.64in wire 3.75in  
 wire X78 (115, 51) pad 21 distance 46mm 1.8in +2.3= 4.12in wire 4.50in  
 wire X77 (132, 52) pad 22 distance 41mm 1.6in +2.3= 3.92in wire 4.00in  
 wire W77 (123, 66) pad 23 distance 38mm 1.5in +2.3= 3.83in wire 4.00in

Longest wire X83 at 105.5mm 4.15in Mean dist 97.7mm 3.85in

7 3.75-inch wires 13 4-inch wires 4 4.5-inch wires 0 5-inch wires 0 longer wires

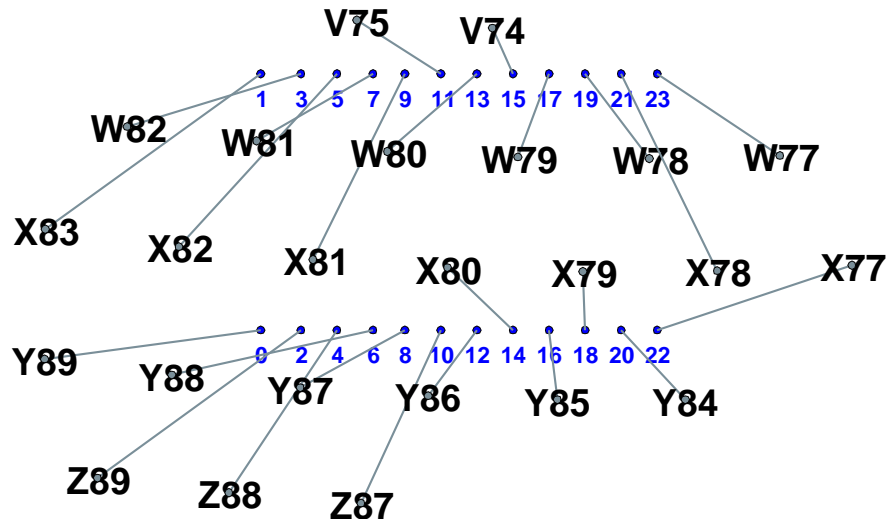

## H12

wire Y97 ( 42, 39) pad 0 distance 35mm 1.4in +2.3= 3.71in wire 3.75in  
 wire X91 ( 31, 57) pad 1 distance 46mm 1.8in +2.3= 4.15in wire 4.50in  
 wire X90 ( 48, 54) pad 2 distance 38mm 1.5in +2.3= 3.84in wire 4.00in  
 wire W90 ( 41, 69) pad 3 distance 39mm 1.6in +2.3= 3.88in wire 4.00in  
 wire Y96 ( 58, 37) pad 4 distance 34mm 1.3in +2.3= 3.65in wire 3.75in  
 wire W89 ( 58, 68) pad 5 distance 37mm 1.4in +2.3= 3.76in wire 4.00in  
 wire X89 ( 65, 53) pad 6 distance 34mm 1.3in +2.3= 3.65in wire 3.75in  
 wire V83 ( 61, 83) pad 7 distance 34mm 1.3in +2.3= 3.66in wire 3.75in  
 wire Z96 ( 65, 23) pad 8 distance 37mm 1.5in +2.3= 3.79in wire 4.00in  
 wire W88 ( 74, 66) pad 9 distance 37mm 1.5in +2.3= 3.78in wire 4.00in  
 wire Y95 ( 74, 36) pad 10 distance 34mm 1.3in +2.3= 3.65in wire 3.75in  
 wire V82 ( 78, 82) pad 11 distance 33mm 1.3in +2.3= 3.62in wire 3.75in  
 wire Z95 ( 81, 22) pad 12 distance 37mm 1.4in +2.3= 3.76in wire 4.00in  
 wire X88 ( 82, 52) pad 13 distance 46mm 1.8in +2.3= 4.12in wire 4.50in  
 wire Y94 ( 90, 35) pad 14 distance 33mm 1.3in +2.3= 3.63in wire 3.75in  
 wire W87 ( 90, 65) pad 15 distance 37mm 1.5in +2.3= 3.80in wire 4.00in  
 wire Y93 (106, 35) pad 16 distance 34mm 1.4in +2.3= 3.68in wire 3.75in  
 wire X87 ( 98, 51) pad 17 distance 46mm 1.8in +2.3= 4.13in wire 4.50in  
 wire X86 (115, 51) pad 18 distance 38mm 1.5in +2.3= 3.83in wire 4.00in  
 wire W86 (107, 65) pad 19 distance 38mm 1.5in +2.3= 3.82in wire 4.00in  
 wire Y92 (122, 35) pad 20 distance 37mm 1.4in +2.3= 3.77in wire 4.00in  
 wire W85 (123, 66) pad 21 distance 40mm 1.6in +2.3= 3.90in wire 4.00in  
 wire X85 (132, 52) pad 22 distance 41mm 1.6in +2.3= 3.92in wire 4.00in  
 wire X84 (149, 53) pad 23 distance 57mm 2.3in +2.3= 4.57in wire 5.00in

Longest wire X84 at 116.2mm 4.57in Mean dist 97.4mm 3.84in

8 3.75-inch wires 12 4-inch wires 3 4.5-inch wires 1 5-inch wires 0 longer wires

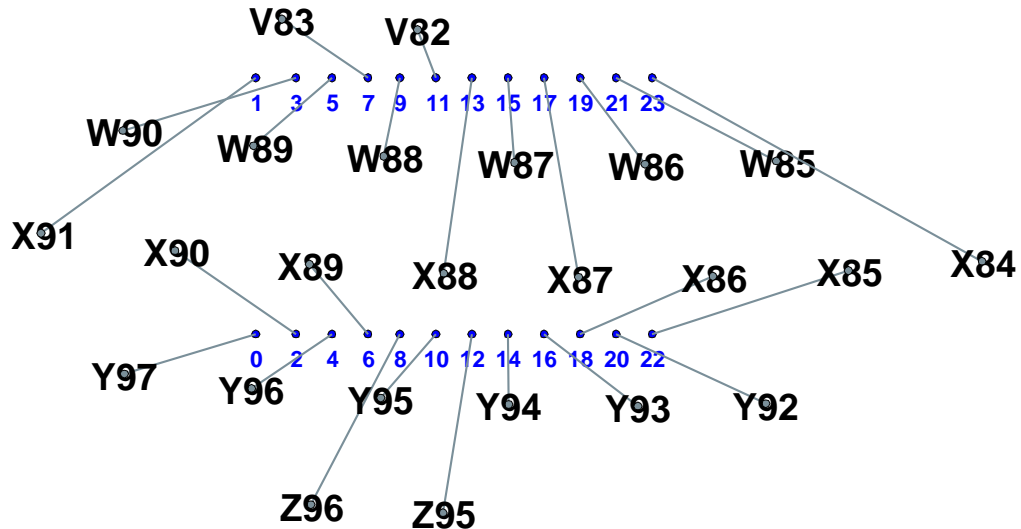

## H13

wire X98 ( 31, 57) pad 0 distance 44mm 1.7in +2.3= 4.05in wire 4.50in  
 wire W98 ( 25, 72) pad 1 distance 44mm 1.7in +2.3= 4.06in wire 4.50in  
 wire Y105 ( 35, 40) pad 2 distance 41mm 1.6in +2.3= 3.93in wire 4.00in  
 wire V91 ( 37, 86) pad 3 distance 40mm 1.6in +2.3= 3.90in wire 4.00in  
 wire Y104 ( 51, 38) pad 4 distance 36mm 1.4in +2.3= 3.72in wire 3.75in  
 wire W97 ( 41, 69) pad 5 distance 42mm 1.7in +2.3= 3.97in wire 4.00in  
 wire X96 ( 65, 53) pad 6 distance 34mm 1.3in +2.3= 3.65in wire 3.75in  
 wire X97 ( 48, 54) pad 7 distance 48mm 1.9in +2.3= 4.23in wire 4.50in  
 wire Z104 ( 58, 23) pad 8 distance 40mm 1.6in +2.3= 3.88in wire 4.00in  
 wire W96 ( 58, 68) pad 9 distance 40mm 1.6in +2.3= 3.91in wire 4.00in  
 wire Y103 ( 67, 36) pad 10 distance 36mm 1.4in +2.3= 3.72in wire 3.75in  
 wire W95 ( 74, 66) pad 11 distance 37mm 1.5in +2.3= 3.80in wire 4.00in  
 wire Z103 ( 74, 22) pad 12 distance 38mm 1.5in +2.3= 3.81in wire 4.00in  
 wire X95 ( 81, 52) pad 13 distance 46mm 1.8in +2.3= 4.12in wire 4.50in  
 wire Y102 ( 83, 36) pad 14 distance 34mm 1.3in +2.3= 3.66in wire 3.75in  
 wire W94 ( 90, 66) pad 15 distance 37mm 1.5in +2.3= 3.79in wire 4.00in  
 wire Y101 ( 99, 35) pad 16 distance 33mm 1.3in +2.3= 3.63in wire 3.75in  
 wire X94 ( 98, 51) pad 17 distance 46mm 1.8in +2.3= 4.13in wire 4.50in  
 wire Y100 (115, 35) pad 18 distance 36mm 1.4in +2.3= 3.74in wire 3.75in  
 wire W93 (107, 65) pad 19 distance 38mm 1.5in +2.3= 3.81in wire 4.00in  
 wire X93 (115, 51) pad 20 distance 37mm 1.4in +2.3= 3.77in wire 4.00in  
 wire W92 (123, 66) pad 21 distance 40mm 1.6in +2.3= 3.90in wire 4.00in  
 wire X92 (132, 52) pad 22 distance 41mm 1.6in +2.3= 3.93in wire 4.00in  
 wire W91 (139, 67) pad 23 distance 45mm 1.8in +2.3= 4.11in wire 4.50in

Longest wire X97 at 107.5mm 4.23in Mean dist 98.7mm 3.88in

6 3.75-inch wires 12 4-inch wires 6 4.5-inch wires 0 5-inch wires 0 longer wires

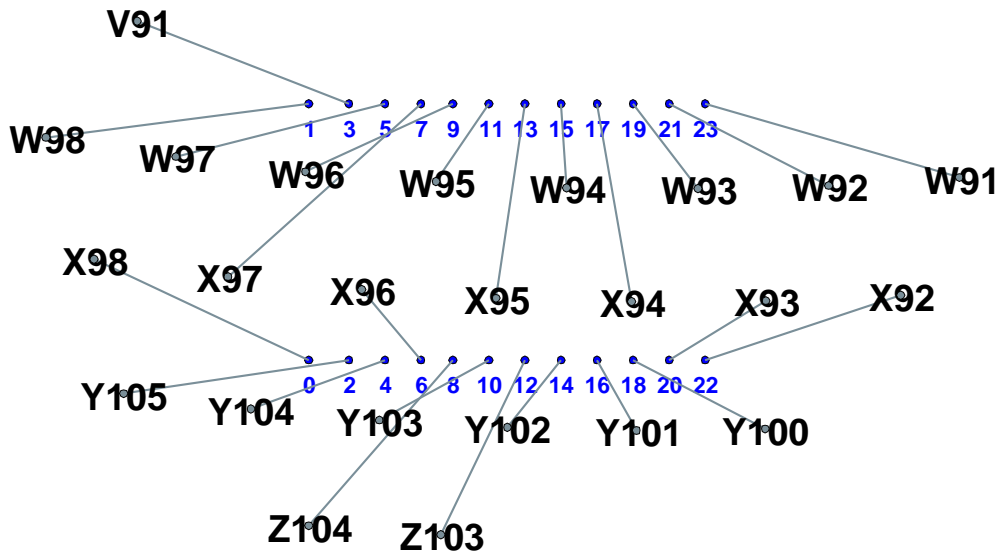



## H14

wire X106 ( 31, 57) pad 0 distance 44mm 1.7in +2.3= 4.05in wire 4.50in  
 wire W106 ( 25, 72) pad 1 distance 44mm 1.7in +2.3= 4.06in wire 4.50in  
 wire Y113 ( 45, 39) pad 2 distance 36mm 1.4in +2.3= 3.73in wire 3.75in  
 wire W105 ( 42, 70) pad 3 distance 39mm 1.6in +2.3= 3.87in wire 4.00in  
 wire Y112 ( 61, 37) pad 4 distance 33mm 1.3in +2.3= 3.63in wire 3.75in  
 wire X105 ( 48, 54) pad 5 distance 46mm 1.8in +2.3= 4.13in wire 4.50in  
 wire X104 ( 65, 53) pad 6 distance 34mm 1.3in +2.3= 3.65in wire 3.75in  
 wire W104 ( 58, 68) pad 7 distance 38mm 1.5in +2.3= 3.82in wire 4.00in  
 wire Z112 ( 69, 22) pad 8 distance 37mm 1.4in +2.3= 3.76in wire 4.00in  
 wire W103 ( 74, 66) pad 9 distance 37mm 1.5in +2.3= 3.78in wire 4.00in  
 wire Y111 ( 77, 36) pad 10 distance 33mm 1.3in +2.3= 3.63in wire 3.75in  
 wire X103 ( 82, 52) pad 11 distance 45mm 1.8in +2.3= 4.11in wire 4.50in  
 wire Z111 ( 85, 22) pad 12 distance 36mm 1.4in +2.3= 3.75in wire 4.00in  
 wire W102 ( 90, 66) pad 13 distance 38mm 1.5in +2.3= 3.81in wire 4.00in  
 wire Y110 ( 94, 35) pad 14 distance 33mm 1.3in +2.3= 3.63in wire 3.75in  
 wire X102 ( 98, 51) pad 15 distance 47mm 1.8in +2.3= 4.15in wire 4.50in  
 wire Z110 (102, 21) pad 16 distance 37mm 1.5in +2.3= 3.78in wire 4.00in  
 wire W101 (107, 65) pad 17 distance 39mm 1.5in +2.3= 3.86in wire 4.00in  
 wire Y109 (110, 35) pad 18 distance 34mm 1.3in +2.3= 3.67in wire 3.75in  
 wire X101 (115, 51) pad 19 distance 48mm 1.9in +2.3= 4.21in wire 4.50in  
 wire Y108 (126, 36) pad 20 distance 38mm 1.5in +2.3= 3.84in wire 4.00in  
 wire W100 (123, 66) pad 21 distance 40mm 1.6in +2.3= 3.90in wire 4.00in  
 wire X100 (132, 52) pad 22 distance 41mm 1.6in +2.3= 3.93in wire 4.00in  
 wire W99 (139, 67) pad 23 distance 45mm 1.8in +2.3= 4.11in wire 4.50in

Longest wire X101 at 106.8mm 4.21in Mean dist 98.3mm 3.87in

6 3.75-inch wires 11 4-inch wires 7 4.5-inch wires 0 5-inch wires 0 longer wires

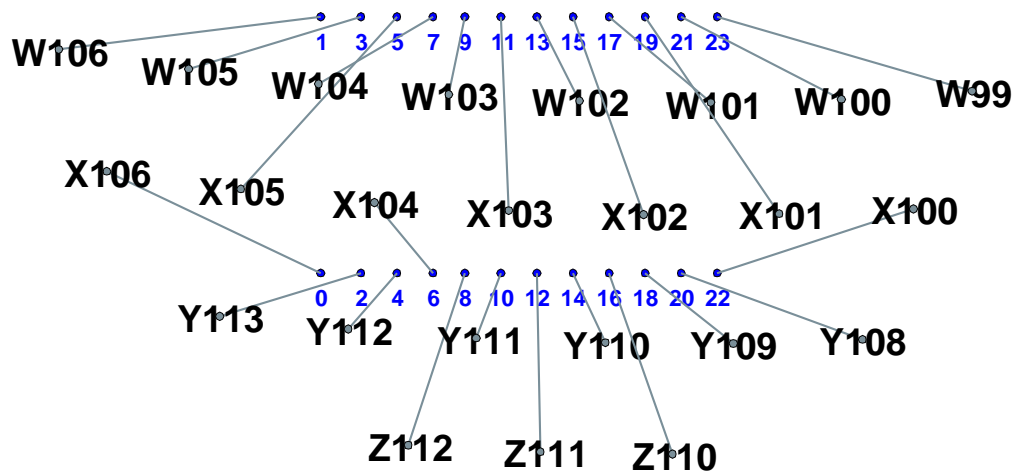

## H15

wire X113 ( 48, 54) pad 0 distance 37mm 1.5in +2.3= 3.78in wire 4.00in  
 wire X114 ( 31, 57) pad 1 distance 46mm 1.8in +2.3= 4.15in wire 4.50in  
 wire Y121 ( 56, 38) pad 2 distance 33mm 1.3in +2.3= 3.63in wire 3.75in  
 wire W113 ( 41, 70) pad 3 distance 39mm 1.6in +2.3= 3.88in wire 4.00in  
 wire Y120 ( 72, 36) pad 4 distance 34mm 1.3in +2.3= 3.66in wire 3.75in  
 wire W112 ( 58, 68) pad 5 distance 37mm 1.4in +2.3= 3.76in wire 4.00in  
 wire X112 ( 65, 53) pad 6 distance 34mm 1.3in +2.3= 3.65in wire 3.75in  
 wire W111 ( 74, 66) pad 7 distance 37mm 1.5in +2.3= 3.79in wire 4.00in  
 wire Z120 ( 80, 22) pad 8 distance 37mm 1.4in +2.3= 3.76in wire 4.00in  
 wire X111 ( 82, 52) pad 9 distance 46mm 1.8in +2.3= 4.13in wire 4.50in  
 wire Y119 ( 88, 36) pad 10 distance 34mm 1.3in +2.3= 3.66in wire 3.75in  
 wire V103 ( 86, 82) pad 11 distance 34mm 1.3in +2.3= 3.65in wire 3.75in  
 wire Z119 ( 96, 22) pad 12 distance 38mm 1.5in +2.3= 3.83in wire 4.00in  
 wire W110 ( 90, 66) pad 13 distance 38mm 1.5in +2.3= 3.80in wire 4.00in  
 wire Y118 (104, 35) pad 14 distance 36mm 1.4in +2.3= 3.72in wire 3.75in  
 wire X110 ( 98, 51) pad 15 distance 46mm 1.8in +2.3= 4.15in wire 4.50in  
 wire Z118 (113, 22) pad 16 distance 40mm 1.6in +2.3= 3.90in wire 4.00in  
 wire W109 (107, 66) pad 17 distance 39mm 1.5in +2.3= 3.85in wire 4.00in  
 wire X109 (115, 52) pad 18 distance 38mm 1.5in +2.3= 3.83in wire 4.00in  
 wire W108 (123, 66) pad 19 distance 43mm 1.7in +2.3= 4.02in wire 4.50in  
 wire Y117 (120, 36) pad 20 distance 36mm 1.4in +2.3= 3.74in wire 3.75in  
 wire W107 (139, 67) pad 21 distance 49mm 1.9in +2.3= 4.24in wire 4.50in  
 wire X108 (132, 52) pad 22 distance 41mm 1.6in +2.3= 3.93in wire 4.00in  
 wire X107 (149, 54) pad 23 distance 57mm 2.2in +2.3= 4.56in wire 5.00in

Longest wire X107 at 115.9mm 4.56in Mean dist 98.5mm 3.88in

7 3.75-inch wires 11 4-inch wires 5 4.5-inch wires 1 5-inch wires 0 longer wires

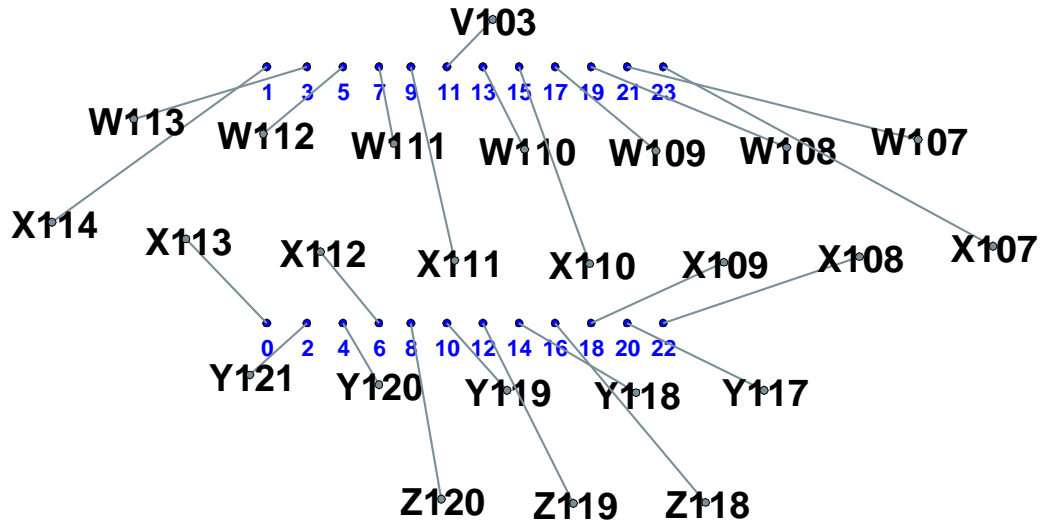

## H16

wire X121 ( 31, 57) pad 0 distance 44mm 1.7in +2.3= 4.05in wire 4.50in  
 wire W121 ( 25, 72) pad 1 distance 44mm 1.7in +2.3= 4.06in wire 4.50in  
 wire Y129 ( 49, 38) pad 2 distance 34mm 1.4in +2.3= 3.68in wire 3.75in  
 wire W120 ( 41, 69) pad 3 distance 39mm 1.6in +2.3= 3.88in wire 4.00in  
 wire Y128 ( 65, 37) pad 4 distance 33mm 1.3in +2.3= 3.62in wire 3.75in  
 wire X120 ( 48, 54) pad 5 distance 46mm 1.8in +2.3= 4.13in wire 4.50in  
 wire X119 ( 65, 53) pad 6 distance 34mm 1.3in +2.3= 3.65in wire 3.75in  
 wire W119 ( 58, 68) pad 7 distance 38mm 1.5in +2.3= 3.83in wire 4.00in  
 wire Y127 ( 81, 36) pad 8 distance 34mm 1.3in +2.3= 3.65in wire 3.75in  
 wire W118 ( 74, 66) pad 9 distance 37mm 1.5in +2.3= 3.78in wire 4.00in  
 wire Z127 ( 89, 22) pad 10 distance 38mm 1.5in +2.3= 3.80in wire 4.00in  
 wire X118 ( 81, 52) pad 11 distance 46mm 1.8in +2.3= 4.11in wire 4.50in  
 wire Y126 ( 97, 35) pad 12 distance 35mm 1.4in +2.3= 3.71in wire 3.75in  
 wire W117 ( 90, 66) pad 13 distance 38mm 1.5in +2.3= 3.81in wire 4.00in  
 wire X117 ( 98, 51) pad 14 distance 37mm 1.4in +2.3= 3.77in wire 4.00in  
 wire W116 (107, 65) pad 15 distance 41mm 1.6in +2.3= 3.94in wire 4.00in  
 wire Z126 (106, 21) pad 16 distance 38mm 1.5in +2.3= 3.81in wire 4.00in  
 wire V108 (112, 82) pad 17 distance 37mm 1.4in +2.3= 3.77in wire 4.00in  
 wire Y125 (113, 35) pad 18 distance 35mm 1.4in +2.3= 3.71in wire 3.75in  
 wire W115 (123, 66) pad 19 distance 43mm 1.7in +2.3= 4.02in wire 4.50in  
 wire X116 (115, 51) pad 20 distance 37mm 1.4in +2.3= 3.77in wire 4.00in  
 wire V107 (129, 82) pad 21 distance 40mm 1.6in +2.3= 3.89in wire 4.00in  
 wire X115 (132, 52) pad 22 distance 41mm 1.6in +2.3= 3.92in wire 4.00in  
 wire W114 (139, 67) pad 23 distance 46mm 1.8in +2.3= 4.11in wire 4.50in

Longest wire X120 at 104.9mm 4.13in Mean dist 97.9mm 3.85in

6 3.75-inch wires 12 4-inch wires 6 4.5-inch wires 0 5-inch wires 0 longer wires

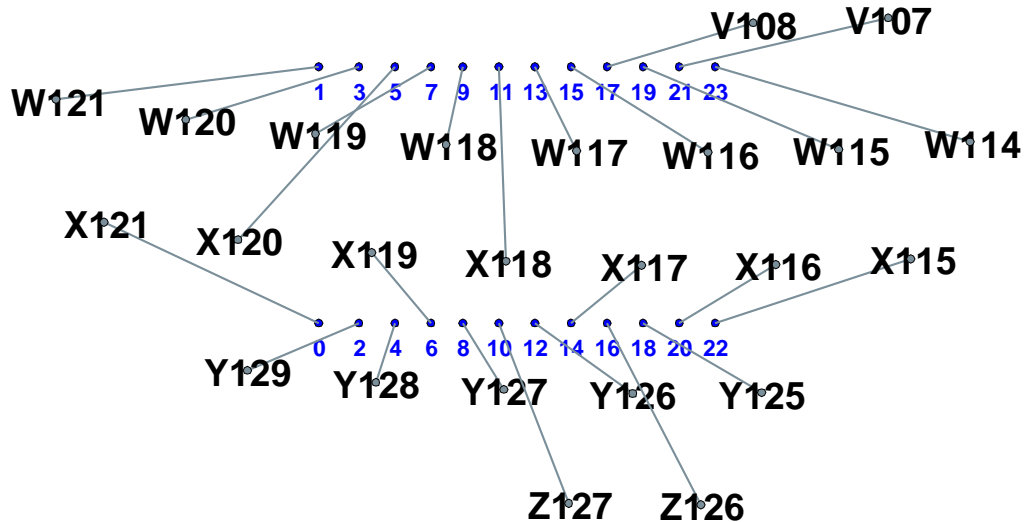

# H17

wire Y138 ( 44, 39) pad 0 distance 35mm 1.4in +2.3= 3.68in wire 3.75in  
 wire X129 ( 31, 57) pad 1 distance 46mm 1.8in +2.3= 4.15in wire 4.50in  
 wire X128 ( 48, 54) pad 2 distance 38mm 1.5in +2.3= 3.84in wire 4.00in  
 wire W128 ( 42, 70) pad 3 distance 39mm 1.6in +2.3= 3.87in wire 4.00in  
 wire Y137 ( 60, 37) pad 4 distance 33mm 1.3in +2.3= 3.63in wire 3.75in  
 wire W127 ( 58, 68) pad 5 distance 37mm 1.4in +2.3= 3.76in wire 4.00in  
 wire X127 ( 65, 53) pad 6 distance 34mm 1.3in +2.3= 3.65in wire 3.75in  
 wire W126 ( 74, 66) pad 7 distance 37mm 1.5in +2.3= 3.79in wire 4.00in  
 wire Y136 ( 76, 36) pad 8 distance 33mm 1.3in +2.3= 3.62in wire 3.75in  
 wire X126 ( 82, 52) pad 9 distance 46mm 1.8in +2.3= 4.13in wire 4.50in  
 wire Y135 ( 92, 35) pad 10 distance 35mm 1.4in +2.3= 3.70in wire 3.75in  
 wire W125 ( 90, 65) pad 11 distance 39mm 1.5in +2.3= 3.85in wire 4.00in  
 wire X125 ( 98, 51) pad 12 distance 38mm 1.5in +2.3= 3.83in wire 4.00in  
 wire V116 (103, 81) pad 13 distance 38mm 1.5in +2.3= 3.81in wire 4.00in  
 wire Y134 (108, 35) pad 14 distance 37mm 1.5in +2.3= 3.78in wire 4.00in  
 wire W124 (107, 65) pad 15 distance 41mm 1.6in +2.3= 3.94in wire 4.00in  
 wire Z134 (117, 21) pad 16 distance 42mm 1.7in +2.3= 3.97in wire 4.00in  
 wire X124 (115, 51) pad 17 distance 50mm 2.0in +2.3= 4.28in wire 4.50in  
 wire Y133 (124, 35) pad 18 distance 40mm 1.6in +2.3= 3.91in wire 4.00in  
 wire W123 (123, 66) pad 19 distance 43mm 1.7in +2.3= 4.03in wire 4.50in  
 wire X123 (132, 52) pad 20 distance 44mm 1.7in +2.3= 4.07in wire 4.50in  
 wire W122 (139, 66) pad 21 distance 49mm 1.9in +2.3= 4.24in wire 4.50in  
 wire Y132 (140, 36) pad 22 distance 43mm 1.7in +2.3= 4.03in wire 4.50in  
 wire X122 (149, 53) pad 23 distance 57mm 2.3in +2.3= 4.58in wire 5.00in

Longest wire X122 at 116.3mm 4.58in Mean dist 99.6mm 3.92in

5 3.75-inch wires 11 4-inch wires 7 4.5-inch wires 1 5-inch wires 0 longer wires

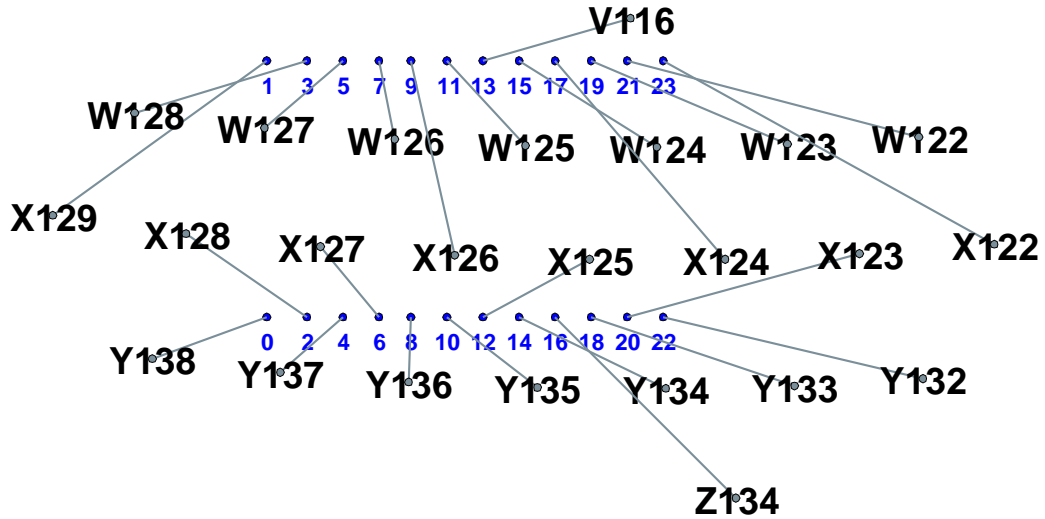

## H18

wire Y146 ( 37, 40) pad 0 distance 37mm 1.5in +2.3= 3.78in wire 4.00in  
 wire X136 ( 31, 57) pad 1 distance 46mm 1.8in +2.3= 4.15in wire 4.50in  
 wire X135 ( 48, 54) pad 2 distance 38mm 1.5in +2.3= 3.84in wire 4.00in  
 wire W135 ( 41, 70) pad 3 distance 39mm 1.6in +2.3= 3.88in wire 4.00in  
 wire Y145 ( 53, 38) pad 4 distance 35mm 1.4in +2.3= 3.69in wire 3.75in  
 wire W134 ( 58, 68) pad 5 distance 37mm 1.4in +2.3= 3.76in wire 4.00in  
 wire X134 ( 65, 53) pad 6 distance 34mm 1.3in +2.3= 3.65in wire 3.75in  
 wire W133 ( 74, 66) pad 7 distance 37mm 1.5in +2.3= 3.79in wire 4.00in  
 wire Y144 ( 69, 36) pad 8 distance 34mm 1.3in +2.3= 3.64in wire 3.75in  
 wire V124 ( 79, 82) pad 9 distance 33mm 1.3in +2.3= 3.63in wire 3.75in  
 wire X133 ( 82, 52) pad 10 distance 36mm 1.4in +2.3= 3.75in wire 3.75in  
 wire U124 ( 88, 96) pad 11 distance 36mm 1.4in +2.3= 3.75in wire 3.75in  
 wire Y143 ( 85, 36) pad 12 distance 33mm 1.3in +2.3= 3.62in wire 3.75in  
 wire W132 ( 90, 66) pad 13 distance 38mm 1.5in +2.3= 3.80in wire 4.00in  
 wire X132 ( 98, 51) pad 14 distance 37mm 1.4in +2.3= 3.77in wire 4.00in  
 wire V123 ( 96, 82) pad 15 distance 33mm 1.3in +2.3= 3.64in wire 3.75in  
 wire Y142 (101, 35) pad 16 distance 33mm 1.3in +2.3= 3.64in wire 3.75in  
 wire W131 (107, 66) pad 17 distance 39mm 1.5in +2.3= 3.85in wire 4.00in  
 wire X131 (115, 52) pad 18 distance 38mm 1.5in +2.3= 3.84in wire 4.00in  
 wire W130 (123, 66) pad 19 distance 43mm 1.7in +2.3= 4.02in wire 4.50in  
 wire Y141 (117, 36) pad 20 distance 35mm 1.4in +2.3= 3.70in wire 3.75in  
 wire X130 (132, 52) pad 21 distance 51mm 2.0in +2.3= 4.33in wire 4.50in  
 wire Y140 (133, 36) pad 22 distance 39mm 1.5in +2.3= 3.87in wire 4.00in  
 wire W129 (139, 67) pad 23 distance 45mm 1.8in +2.3= 4.11in wire 4.50in

Longest wire X130 at 110.0mm 4.33in Mean dist 96.8mm 3.81in

10 3.75-inch wires 10 4-inch wires 4 4.5-inch wires 0 5-inch wires 0 longer wires

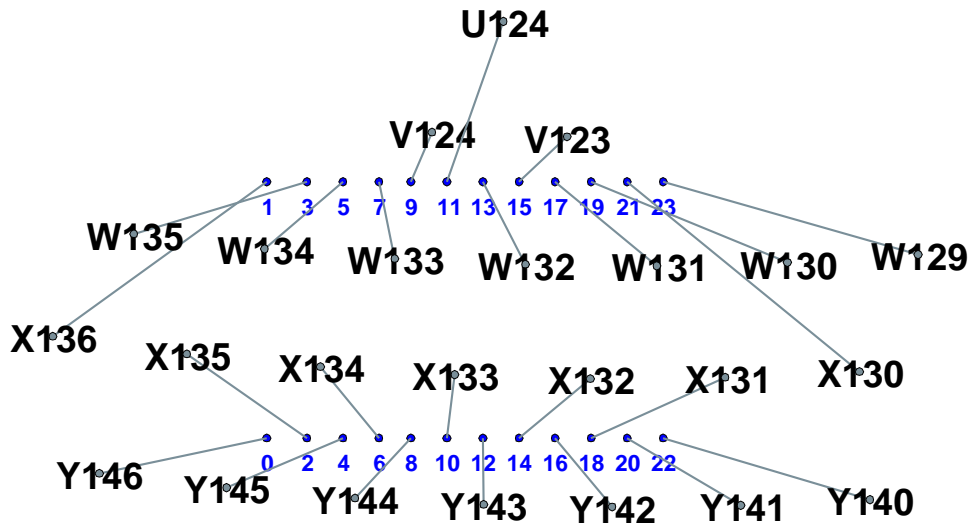

# H19

wire Y155 ( 32, 40) pad 0 distance 40mm 1.6in +2.3= 3.89in wire 4.00in  
wire W144 ( 25, 72) pad 1 distance 44mm 1.7in +2.3= 4.06in wire 4.50in  
wire Y154 ( 48, 38) pad 2 distance 35mm 1.4in +2.3= 3.70in wire 3.75in  
wire X144 ( 31, 57) pad 3 distance 50mm 2.0in +2.3= 4.29in wire 4.50in  
wire X143 ( 48, 54) pad 4 distance 40mm 1.6in +2.3= 3.91in wire 4.00in  
wire W143 ( 41, 70) pad 5 distance 42mm 1.6in +2.3= 3.97in wire 4.00in  
wire X142 ( 65, 53) pad 6 distance 34mm 1.3in +2.3= 3.65in wire 3.75in  
wire W142 ( 58, 68) pad 7 distance 38mm 1.5in +2.3= 3.82in wire 4.00in  
wire Y153 ( 64, 37) pad 8 distance 35mm 1.4in +2.3= 3.70in wire 3.75in  
wire V132 ( 70, 83) pad 9 distance 33mm 1.3in +2.3= 3.64in wire 3.75in  
wire Y152 ( 80, 36) pad 10 distance 33mm 1.3in +2.3= 3.62in wire 3.75in  
wire W141 ( 74, 66) pad 11 distance 37mm 1.5in +2.3= 3.80in wire 4.00in  
wire X141 ( 82, 52) pad 12 distance 36mm 1.4in +2.3= 3.75in wire 4.00in  
wire V131 ( 87, 82) pad 13 distance 33mm 1.3in +2.3= 3.62in wire 3.75in  
wire Y151 ( 96, 35) pad 14 distance 33mm 1.3in +2.3= 3.64in wire 3.75in  
wire W140 ( 90, 66) pad 15 distance 37mm 1.5in +2.3= 3.79in wire 4.00in  
wire X140 ( 98, 51) pad 16 distance 36mm 1.4in +2.3= 3.74in wire 3.75in  
wire W139 (107, 66) pad 17 distance 39mm 1.5in +2.3= 3.85in wire 4.00in  
wire Y150 (112, 35) pad 18 distance 35mm 1.4in +2.3= 3.69in wire 3.75in  
wire X139 (115, 52) pad 19 distance 48mm 1.9in +2.3= 4.20in wire 4.50in  
wire Y149 (128, 36) pad 20 distance 40mm 1.6in +2.3= 3.88in wire 4.00in  
wire X138 (132, 52) pad 21 distance 51mm 2.0in +2.3= 4.33in wire 4.50in  
wire Y148 (144, 37) pad 22 distance 46mm 1.8in +2.3= 4.13in wire 4.50in  
wire X137 (149, 54) pad 23 distance 57mm 2.2in +2.3= 4.57in wire 5.00in

Longest wire X137 at 116.1mm 4.57in Mean dist 98.7mm 3.89in

9 3.75-inch wires 9 4-inch wires 5 4.5-inch wires 1 5-inch wires 0 longer wires

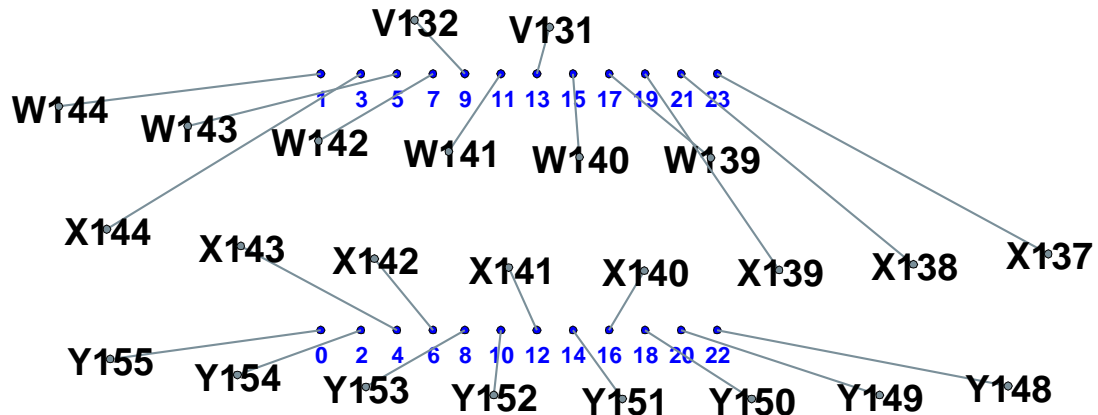

## H20

wire X151 ( 31, 57) pad 0 distance 44mm 1.7in +2.3= 4.05in wire 4.50in  
wire X152 ( 15, 59) pad 1 distance 55mm 2.2in +2.3= 4.49in wire 4.50in  
wire Y162 ( 41, 39) pad 2 distance 38mm 1.5in +2.3= 3.80in wire 4.00in  
wire W150 ( 42, 70) pad 3 distance 39mm 1.6in +2.3= 3.87in wire 4.00in  
wire Y161 ( 57, 38) pad 4 distance 34mm 1.3in +2.3= 3.65in wire 3.75in  
wire V140 ( 45, 85) pad 5 distance 38mm 1.5in +2.3= 3.83in wire 4.00in  
wire X150 ( 48, 54) pad 6 distance 40mm 1.6in +2.3= 3.88in wire 4.00in  
wire U140 ( 55, 98) pad 7 distance 39mm 1.5in +2.3= 3.86in wire 4.00in  
wire X149 ( 65, 53) pad 8 distance 38mm 1.5in +2.3= 3.82in wire 4.00in  
wire W149 ( 58, 68) pad 9 distance 40mm 1.6in +2.3= 3.91in wire 4.00in  
wire Y160 ( 73, 36) pad 10 distance 34mm 1.3in +2.3= 3.65in wire 3.75in  
wire V139 ( 62, 84) pad 11 distance 38mm 1.5in +2.3= 3.80in wire 4.00in  
wire X148 ( 82, 52) pad 12 distance 36mm 1.4in +2.3= 3.76in wire 4.00in  
wire W148 ( 74, 66) pad 13 distance 38mm 1.5in +2.3= 3.84in wire 4.00in  
wire Y159 ( 89, 36) pad 14 distance 33mm 1.3in +2.3= 3.63in wire 3.75in  
wire W147 ( 90, 66) pad 15 distance 37mm 1.5in +2.3= 3.79in wire 4.00in  
wire Y158 (105, 36) pad 16 distance 34mm 1.3in +2.3= 3.67in wire 3.75in  
wire X147 ( 98, 52) pad 17 distance 46mm 1.8in +2.3= 4.12in wire 4.50in  
wire X146 (115, 52) pad 18 distance 39mm 1.5in +2.3= 3.84in wire 4.00in  
wire W146 (107, 66) pad 19 distance 38mm 1.5in +2.3= 3.81in wire 4.00in  
wire Y157 (121, 36) pad 20 distance 36mm 1.4in +2.3= 3.75in wire 4.00in  
wire W145 (123, 66) pad 21 distance 40mm 1.6in +2.3= 3.89in wire 4.00in  
wire Y156 (137, 37) pad 22 distance 42mm 1.6in +2.3= 3.96in wire 4.00in  
wire X145 (132, 52) pad 23 distance 49mm 1.9in +2.3= 4.24in wire 4.50in

Longest wire X152 at 114.0mm 4.49in Mean dist 98.3mm 3.87in

4 3.75-inch wires 16 4-inch wires 4 4.5-inch wires 0 5-inch wires 0 longer wires

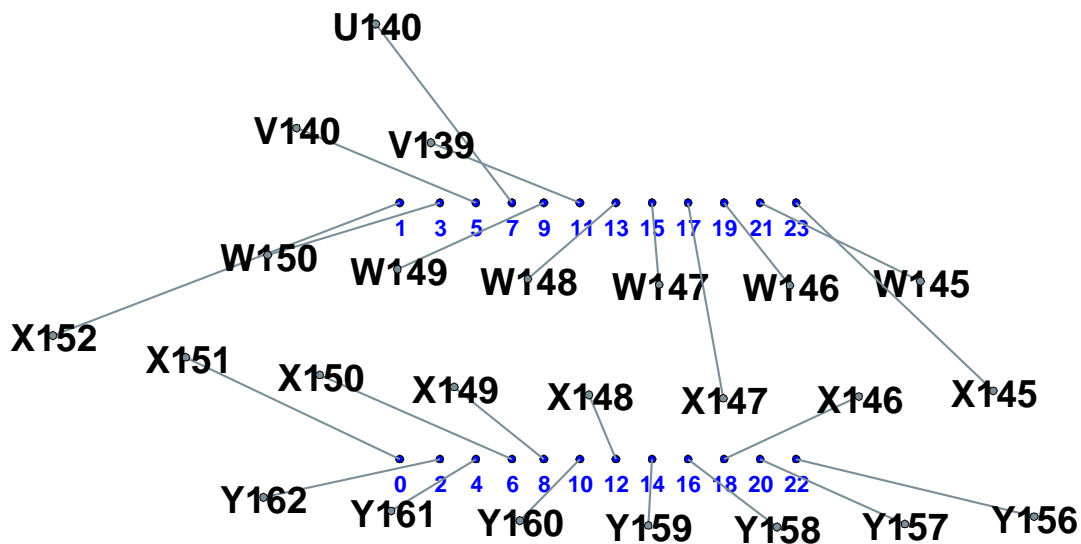

## H21

wire X159 ( 31, 57) pad 0 distance 44mm 1.7in +2.3= 4.04in wire 4.50in  
 wire V148 ( 36, 86) pad 1 distance 37mm 1.5in +2.3= 3.79in wire 4.00in  
 wire Y171 ( 36, 40) pad 2 distance 41mm 1.6in +2.3= 3.92in wire 4.00in  
 wire W158 ( 42, 69) pad 3 distance 39mm 1.6in +2.3= 3.87in wire 4.00in  
 wire Y170 ( 52, 38) pad 4 distance 35mm 1.4in +2.3= 3.71in wire 3.75in  
 wire X158 ( 48, 54) pad 5 distance 46mm 1.8in +2.3= 4.13in wire 4.50in  
 wire X157 ( 65, 53) pad 6 distance 34mm 1.3in +2.3= 3.65in wire 3.75in  
 wire V147 ( 53, 84) pad 7 distance 37mm 1.4in +2.3= 3.77in wire 4.00in  
 wire Y169 ( 68, 37) pad 8 distance 34mm 1.3in +2.3= 3.66in wire 3.75in  
 wire W157 ( 58, 68) pad 9 distance 40mm 1.6in +2.3= 3.91in wire 4.00in  
 wire X156 ( 82, 52) pad 10 distance 36mm 1.4in +2.3= 3.75in wire 3.75in  
 wire W156 ( 74, 66) pad 11 distance 37mm 1.5in +2.3= 3.80in wire 4.00in  
 wire Y168 ( 84, 36) pad 12 distance 33mm 1.3in +2.3= 3.62in wire 3.75in  
 wire W155 ( 90, 66) pad 13 distance 38mm 1.5in +2.3= 3.81in wire 4.00in  
 wire Y167 (100, 35) pad 14 distance 34mm 1.3in +2.3= 3.67in wire 3.75in  
 wire X155 ( 98, 51) pad 15 distance 46mm 1.8in +2.3= 4.15in wire 4.50in  
 wire Y166 (116, 36) pad 16 distance 38mm 1.5in +2.3= 3.84in wire 4.00in  
 wire W154 (107, 66) pad 17 distance 39mm 1.5in +2.3= 3.85in wire 4.00in  
 wire X154 (115, 52) pad 18 distance 38mm 1.5in +2.3= 3.84in wire 4.00in  
 wire W153 (123, 66) pad 19 distance 43mm 1.7in +2.3= 4.03in wire 4.50in  
 wire Y165 (132, 36) pad 20 distance 42mm 1.6in +2.3= 3.97in wire 4.00in  
 wire X153 (132, 52) pad 21 distance 51mm 2.0in +2.3= 4.33in wire 4.50in  
 wire Y164 (148, 37) pad 22 distance 49mm 1.9in +2.3= 4.24in wire 4.50in  
 wire W152 (139, 67) pad 23 distance 45mm 1.8in +2.3= 4.11in wire 4.50in

Longest wire X153 at 110.0mm 4.33in Mean dist 98.9mm 3.89in

6 3.75-inch wires 11 4-inch wires 7 4.5-inch wires 0 5-inch wires 0 longer wires

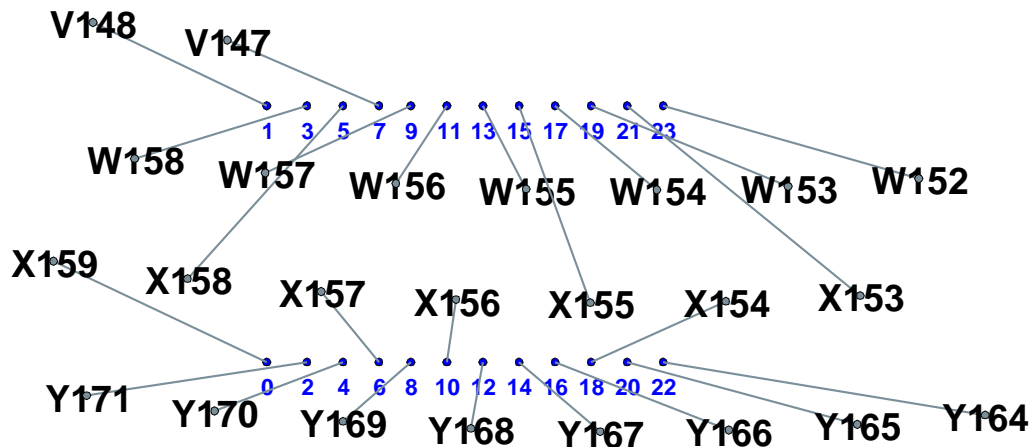



## H22

wire Y179 ( 29, 41) pad 0 distance 42mm 1.6in +2.3= 3.96in wire 4.00in  
 wire W166 ( 25, 72) pad 1 distance 44mm 1.7in +2.3= 4.06in wire 4.50in  
 wire Z179 ( 35, 26) pad 2 distance 42mm 1.7in +2.3= 3.99in wire 4.00in  
 wire X166 ( 31, 57) pad 3 distance 50mm 2.0in +2.3= 4.29in wire 4.50in  
 wire Y178 ( 45, 39) pad 4 distance 38mm 1.5in +2.3= 3.83in wire 4.00in  
 wire W165 ( 41, 70) pad 5 distance 42mm 1.6in +2.3= 3.97in wire 4.00in  
 wire X164 ( 65, 53) pad 6 distance 34mm 1.3in +2.3= 3.65in wire 3.75in  
 wire X165 ( 48, 54) pad 7 distance 48mm 1.9in +2.3= 4.23in wire 4.50in  
 wire Y177 ( 61, 37) pad 8 distance 36mm 1.4in +2.3= 3.74in wire 3.75in  
 wire W164 ( 58, 68) pad 9 distance 40mm 1.6in +2.3= 3.91in wire 4.00in  
 wire Y176 ( 77, 36) pad 10 distance 33mm 1.3in +2.3= 3.63in wire 3.75in  
 wire W163 ( 74, 66) pad 11 distance 37mm 1.5in +2.3= 3.79in wire 4.00in  
 wire Y175 ( 93, 36) pad 12 distance 34mm 1.3in +2.3= 3.66in wire 3.75in  
 wire X163 ( 82, 52) pad 13 distance 45mm 1.8in +2.3= 4.11in wire 4.50in  
 wire X162 ( 98, 52) pad 14 distance 37mm 1.5in +2.3= 3.77in wire 4.00in  
 wire W162 ( 90, 66) pad 15 distance 37mm 1.5in +2.3= 3.79in wire 4.00in  
 wire Y174 (109, 36) pad 16 distance 35mm 1.4in +2.3= 3.72in wire 3.75in  
 wire W161 (107, 66) pad 17 distance 39mm 1.5in +2.3= 3.85in wire 4.00in  
 wire X161 (115, 52) pad 18 distance 38mm 1.5in +2.3= 3.84in wire 4.00in  
 wire W160 (123, 66) pad 19 distance 43mm 1.7in +2.3= 4.02in wire 4.50in  
 wire Y173 (125, 36) pad 20 distance 38mm 1.5in +2.3= 3.82in wire 4.00in  
 wire V149 (130, 83) pad 21 distance 40mm 1.6in +2.3= 3.90in wire 4.00in  
 wire X160 (132, 53) pad 22 distance 41mm 1.6in +2.3= 3.93in wire 4.00in  
 wire W159 (139, 67) pad 23 distance 45mm 1.8in +2.3= 4.11in wire 4.50in

Longest wire X166 at 109.0mm 4.29in Mean dist 99.0mm 3.90in

5 3.75-inch wires 13 4-inch wires 6 4.5-inch wires 0 5-inch wires 0 longer wires

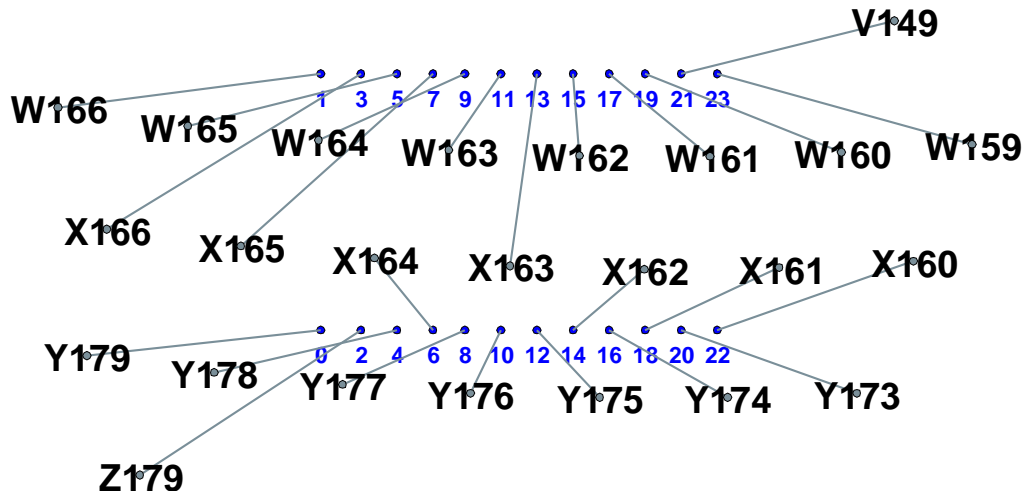

## H23

wire Y188 ( 23, 42) pad 0 distance 45mm 1.8in +2.3= 4.10in wire 4.50in  
wire X174 ( 31, 57) pad 1 distance 46mm 1.8in +2.3= 4.15in wire 4.50in  
wire Y187 ( 39, 39) pad 2 distance 39mm 1.5in +2.3= 3.84in wire 4.00in  
wire X173 ( 48, 54) pad 3 distance 44mm 1.7in +2.3= 4.07in wire 4.50in  
wire Z186 ( 62, 23) pad 4 distance 36mm 1.4in +2.3= 3.75in wire 4.00in  
wire W172 ( 58, 68) pad 5 distance 37mm 1.4in +2.3= 3.76in wire 4.00in  
wire Y186 ( 55, 38) pad 6 distance 37mm 1.5in +2.3= 3.79in wire 4.00in  
wire X172 ( 65, 53) pad 7 distance 45mm 1.8in +2.3= 4.09in wire 4.50in  
wire Y185 ( 71, 36) pad 8 distance 33mm 1.3in +2.3= 3.63in wire 3.75in  
wire W171 ( 74, 66) pad 9 distance 37mm 1.5in +2.3= 3.78in wire 4.00in  
wire Z185 ( 79, 22) pad 10 distance 36mm 1.4in +2.3= 3.75in wire 4.00in  
wire X171 ( 82, 52) pad 11 distance 46mm 1.8in +2.3= 4.11in wire 4.50in  
wire Y184 ( 87, 35) pad 12 distance 33mm 1.3in +2.3= 3.63in wire 3.75in  
wire W170 ( 90, 65) pad 13 distance 38mm 1.5in +2.3= 3.81in wire 4.00in  
wire X170 ( 98, 51) pad 14 distance 37mm 1.4in +2.3= 3.77in wire 4.00in  
wire V158 (104, 81) pad 15 distance 36mm 1.4in +2.3= 3.74in wire 3.75in  
wire Y183 (103, 35) pad 16 distance 34mm 1.3in +2.3= 3.66in wire 3.75in  
wire W169 (107, 65) pad 17 distance 39mm 1.5in +2.3= 3.86in wire 4.00in  
wire X169 (115, 51) pad 18 distance 38mm 1.5in +2.3= 3.83in wire 4.00in  
wire V157 (121, 82) pad 19 distance 39mm 1.5in +2.3= 3.84in wire 4.00in  
wire X168 (132, 52) pad 20 distance 44mm 1.7in +2.3= 4.07in wire 4.50in  
wire W168 (123, 66) pad 21 distance 40mm 1.6in +2.3= 3.91in wire 4.00in  
wire X167 (149, 53) pad 22 distance 51mm 2.0in +2.3= 4.35in wire 4.50in  
wire W167 (139, 66) pad 23 distance 46mm 1.8in +2.3= 4.12in wire 4.50in

Longest wire X167 at 110.4mm 4.35in Mean dist 98.9mm 3.89in

4 3.75-inch wires 12 4-inch wires 8 4.5-inch wires 0 5-inch wires 0 longer wires

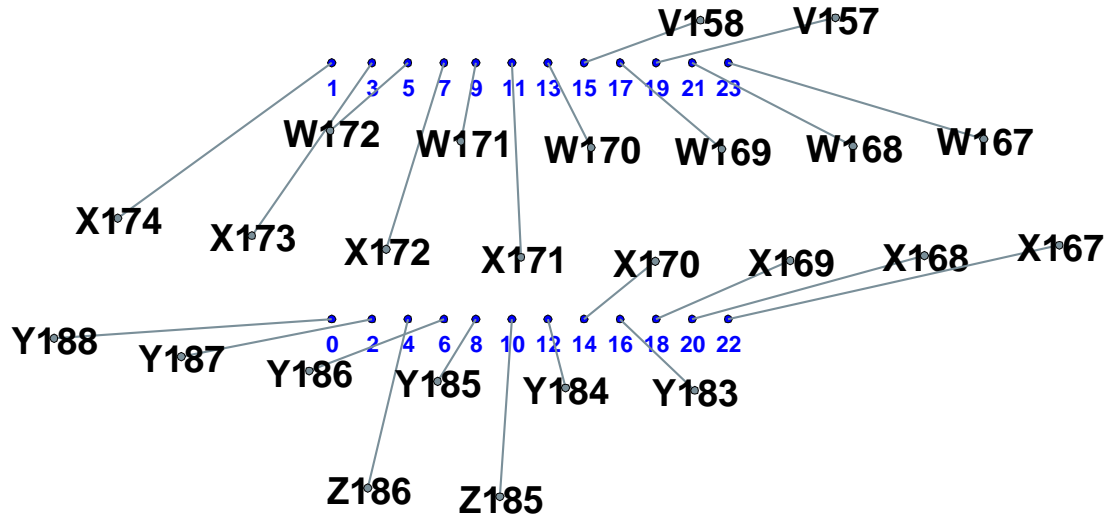

## H24

wire Y195 ( 50, 38) pad 0 distance 33mm 1.3in +2.3= 3.63in wire 3.75in  
 wire X182 ( 31, 57) pad 1 distance 46mm 1.8in +2.3= 4.15in wire 4.50in  
 wire Y194 ( 66, 36) pad 2 distance 34mm 1.3in +2.3= 3.65in wire 3.75in  
 wire X181 ( 48, 54) pad 3 distance 44mm 1.7in +2.3= 4.07in wire 4.50in  
 wire Z194 ( 73, 22) pad 4 distance 38mm 1.5in +2.3= 3.81in wire 4.00in  
 wire W180 ( 58, 68) pad 5 distance 37mm 1.4in +2.3= 3.76in wire 4.00in  
 wire X180 ( 65, 53) pad 6 distance 34mm 1.3in +2.3= 3.65in wire 3.75in  
 wire W179 ( 74, 66) pad 7 distance 37mm 1.5in +2.3= 3.79in wire 4.00in  
 wire Y193 ( 82, 36) pad 8 distance 34mm 1.3in +2.3= 3.65in wire 3.75in  
 wire V167 ( 78, 82) pad 9 distance 33mm 1.3in +2.3= 3.63in wire 3.75in  
 wire Z193 ( 90, 22) pad 10 distance 38mm 1.5in +2.3= 3.81in wire 4.00in  
 wire X179 ( 82, 52) pad 11 distance 46mm 1.8in +2.3= 4.11in wire 4.50in  
 wire Y192 ( 98, 35) pad 12 distance 35mm 1.4in +2.3= 3.72in wire 3.75in  
 wire W178 ( 90, 66) pad 13 distance 38mm 1.5in +2.3= 3.81in wire 4.00in  
 wire X178 ( 98, 51) pad 14 distance 37mm 1.4in +2.3= 3.77in wire 4.00in  
 wire V166 ( 95, 81) pad 15 distance 33mm 1.3in +2.3= 3.64in wire 3.75in  
 wire Y191 (114, 35) pad 16 distance 38mm 1.5in +2.3= 3.80in wire 4.00in  
 wire W177 (107, 65) pad 17 distance 39mm 1.5in +2.3= 3.86in wire 4.00in  
 wire X177 (115, 51) pad 18 distance 38mm 1.5in +2.3= 3.83in wire 4.00in  
 wire V165 (112, 81) pad 19 distance 35mm 1.4in +2.3= 3.69in wire 3.75in  
 wire X176 (132, 52) pad 20 distance 44mm 1.7in +2.3= 4.07in wire 4.50in  
 wire W176 (123, 66) pad 21 distance 40mm 1.6in +2.3= 3.90in wire 4.00in  
 wire X175 (149, 53) pad 22 distance 52mm 2.0in +2.3= 4.35in wire 4.50in  
 wire W175 (139, 67) pad 23 distance 46mm 1.8in +2.3= 4.12in wire 4.50in

Longest wire X175 at 110.5mm 4.35in Mean dist 97.7mm 3.84in

8 3.75-inch wires 10 4-inch wires 6 4.5-inch wires 0 5-inch wires 0 longer wires

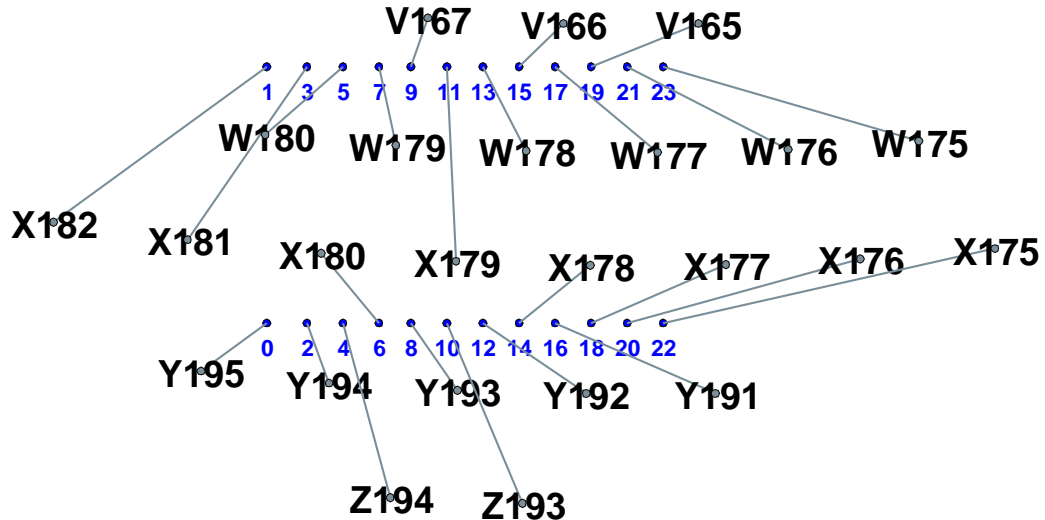

# I1

wire BB4 ( 22, 41) pad 0 distance 46mm 1.8in +2.3= 4.14in wire 4.50in  
 wire AA4 ( 31, 54) pad 1 distance 48mm 1.9in +2.3= 4.21in wire 4.50in  
 wire BB3 ( 38, 39) pad 2 distance 39mm 1.5in +2.3= 3.86in wire 4.00in  
 wire Z3 ( 47, 68) pad 3 distance 38mm 1.5in +2.3= 3.81in wire 4.00in  
 wire BB2 ( 55, 38) pad 4 distance 34mm 1.3in +2.3= 3.67in wire 3.75in  
 wire AA3 ( 47, 52) pad 5 distance 47mm 1.9in +2.3= 4.19in wire 4.50in  
 wire AA2 ( 63, 52) pad 6 distance 34mm 1.3in +2.3= 3.65in wire 3.75in  
 wire Z2 ( 63, 68) pad 7 distance 37mm 1.4in +2.3= 3.77in wire 4.00in  
 wire BB1 ( 71, 38) pad 8 distance 33mm 1.3in +2.3= 3.63in wire 3.75in  
 wire Z1 ( 80, 67) pad 9 distance 37mm 1.5in +2.3= 3.77in wire 4.00in  
 wire AA1 ( 80, 51) pad 10 distance 36mm 1.4in +2.3= 3.74in wire 3.75in  
 wire Y197 ( 88, 81) pad 11 distance 34mm 1.3in +2.3= 3.66in wire 3.75in  
 wire BB209 ( 88, 37) pad 12 distance 33mm 1.3in +2.3= 3.63in wire 3.75in  
 wire Z197 ( 97, 68) pad 13 distance 38mm 1.5in +2.3= 3.83in wire 4.00in  
 wire AA209 ( 96, 51) pad 14 distance 36mm 1.4in +2.3= 3.75in wire 4.00in  
 wire Y196 (104, 82) pad 15 distance 36mm 1.4in +2.3= 3.74in wire 3.75in  
 wire BB208 (104, 38) pad 16 distance 34mm 1.3in +2.3= 3.66in wire 3.75in  
 wire Z196 (113, 68) pad 17 distance 40mm 1.6in +2.3= 3.90in wire 4.00in  
 wire AA208 (112, 52) pad 18 distance 37mm 1.5in +2.3= 3.80in wire 4.00in  
 wire Z195 (130, 69) pad 19 distance 46mm 1.8in +2.3= 4.13in wire 4.50in  
 wire BB207 (121, 39) pad 20 distance 36mm 1.4in +2.3= 3.75in wire 3.75in  
 wire AA207 (128, 53) pad 21 distance 49mm 1.9in +2.3= 4.24in wire 4.50in  
 wire BB206 (137, 40) pad 22 distance 42mm 1.6in +2.3= 3.96in wire 4.00in  
 wire AA206 (144, 55) pad 23 distance 53mm 2.1in +2.3= 4.42in wire 4.50in

Longest wire AA206 at 112.3mm 4.42in Mean dist 98.3mm 3.87in

9 3.75-inch wires 9 4-inch wires 6 4.5-inch wires 0 5-inch wires 0 longer wires

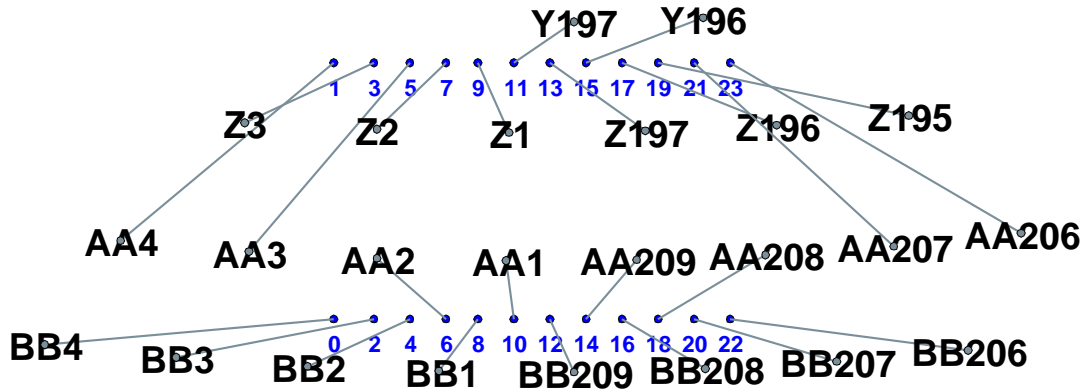

## I2

wire BB12 ( 22, 42) pad 0 distance 46mm 1.8in +2.3= 4.14in wire 4.50in  
 wire AA12 ( 32, 55) pad 1 distance 47mm 1.9in +2.3= 4.19in wire 4.50in  
 wire BB11 ( 38, 40) pad 2 distance 39mm 1.5in +2.3= 3.86in wire 4.00in  
 wire Z11 ( 40, 70) pad 3 distance 40mm 1.6in +2.3= 3.90in wire 4.00in  
 wire BB10 ( 55, 39) pad 4 distance 34mm 1.4in +2.3= 3.67in wire 3.75in  
 wire Z10 ( 56, 69) pad 5 distance 36mm 1.4in +2.3= 3.76in wire 4.00in  
 wire AA11 ( 47, 53) pad 6 distance 40mm 1.6in +2.3= 3.89in wire 4.00in  
 wire Y9 ( 64, 82) pad 7 distance 33mm 1.3in +2.3= 3.64in wire 3.75in  
 wire AA10 ( 64, 52) pad 8 distance 38mm 1.5in +2.3= 3.82in wire 4.00in  
 wire Z9 ( 72, 68) pad 9 distance 36mm 1.4in +2.3= 3.75in wire 4.00in  
 wire BB9 ( 71, 38) pad 10 distance 34mm 1.3in +2.3= 3.67in wire 3.75in  
 wire Y8 ( 80, 82) pad 11 distance 33mm 1.3in +2.3= 3.62in wire 3.75in  
 wire AA9 ( 80, 52) pad 12 distance 37mm 1.4in +2.3= 3.76in wire 4.00in  
 wire X8 ( 81, 98) pad 13 distance 36mm 1.4in +2.3= 3.75in wire 4.00in  
 wire BB8 ( 88, 38) pad 14 distance 33mm 1.3in +2.3= 3.63in wire 3.75in  
 wire Z8 ( 89, 68) pad 15 distance 36mm 1.4in +2.3= 3.75in wire 4.00in  
 wire AA8 ( 96, 52) pad 16 distance 36mm 1.4in +2.3= 3.75in wire 3.75in  
 wire Z7 (106, 68) pad 17 distance 37mm 1.5in +2.3= 3.80in wire 4.00in  
 wire BB7 (104, 38) pad 18 distance 33mm 1.3in +2.3= 3.63in wire 3.75in  
 wire AA7 (112, 52) pad 19 distance 46mm 1.8in +2.3= 4.15in wire 4.50in  
 wire BB6 (120, 39) pad 20 distance 36mm 1.4in +2.3= 3.74in wire 3.75in  
 wire AA6 (128, 53) pad 21 distance 48mm 1.9in +2.3= 4.23in wire 4.50in  
 wire BB5 (137, 40) pad 22 distance 41mm 1.6in +2.3= 3.95in wire 4.00in  
 wire AA5 (144, 55) pad 23 distance 53mm 2.1in +2.3= 4.42in wire 4.50in

Longest wire AA5 at 112.2mm 4.42in Mean dist 97.9mm 3.85in

8 3.75-inch wires 11 4-inch wires 5 4.5-inch wires 0 5-inch wires 0 longer wires

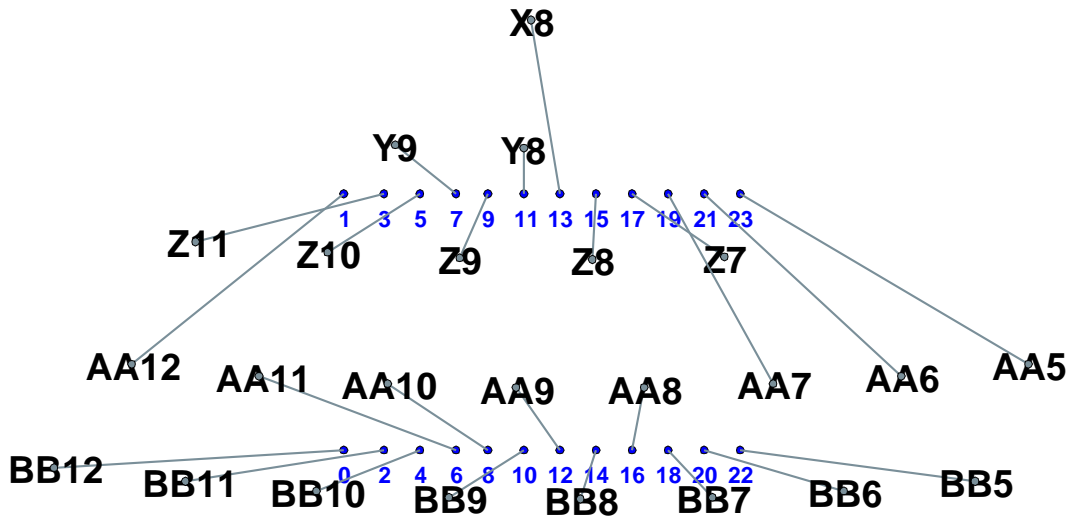

### I3

wire BB20 ( 22, 40) pad 0 distance 46mm 1.8in +2.3= 4.12in wire 4.50in  
 wire AA20 ( 32, 52) pad 1 distance 49mm 1.9in +2.3= 4.23in wire 4.50in  
 wire BB19 ( 39, 38) pad 2 distance 39mm 1.5in +2.3= 3.85in wire 4.00in  
 wire Z19 ( 32, 69) pad 3 distance 45mm 1.8in +2.3= 4.08in wire 4.50in  
 wire BB18 ( 55, 37) pad 4 distance 34mm 1.3in +2.3= 3.67in wire 3.75in  
 wire Z18 ( 48, 67) pad 5 distance 39mm 1.5in +2.3= 3.87in wire 4.00in  
 wire AA19 ( 48, 51) pad 6 distance 39mm 1.6in +2.3= 3.87in wire 4.00in  
 wire Y17 ( 57, 81) pad 7 distance 35mm 1.4in +2.3= 3.71in wire 3.75in  
 wire AA18 ( 64, 51) pad 8 distance 37mm 1.5in +2.3= 3.80in wire 4.00in  
 wire Z17 ( 65, 67) pad 9 distance 38mm 1.5in +2.3= 3.83in wire 4.00in  
 wire BB17 ( 72, 37) pad 10 distance 34mm 1.3in +2.3= 3.66in wire 3.75in  
 wire Y16 ( 73, 80) pad 11 distance 34mm 1.3in +2.3= 3.66in wire 3.75in  
 wire AA17 ( 80, 50) pad 12 distance 36mm 1.4in +2.3= 3.74in wire 3.75in  
 wire Z16 ( 81, 67) pad 13 distance 37mm 1.5in +2.3= 3.78in wire 4.00in  
 wire BB16 ( 88, 37) pad 14 distance 33mm 1.3in +2.3= 3.63in wire 3.75in  
 wire AA16 ( 96, 51) pad 15 distance 46mm 1.8in +2.3= 4.15in wire 4.50in  
 wire BB15 (104, 37) pad 16 distance 34mm 1.3in +2.3= 3.66in wire 3.75in  
 wire Z15 ( 98, 67) pad 17 distance 37mm 1.4in +2.3= 3.77in wire 4.00in  
 wire AA15 (112, 52) pad 18 distance 37mm 1.5in +2.3= 3.79in wire 4.00in  
 wire Z14 (114, 68) pad 19 distance 39mm 1.5in +2.3= 3.85in wire 4.00in  
 wire BB14 (121, 38) pad 20 distance 36mm 1.4in +2.3= 3.75in wire 3.75in  
 wire AA14 (128, 53) pad 21 distance 49mm 1.9in +2.3= 4.24in wire 4.50in  
 wire BB13 (137, 40) pad 22 distance 42mm 1.6in +2.3= 3.96in wire 4.00in  
 wire AA13 (144, 55) pad 23 distance 53mm 2.1in +2.3= 4.42in wire 4.50in

Longest wire AA13 at 112.4mm 4.42in Mean dist 98.5mm 3.88in

8 3.75-inch wires 10 4-inch wires 6 4.5-inch wires 0 5-inch wires 0 longer wires

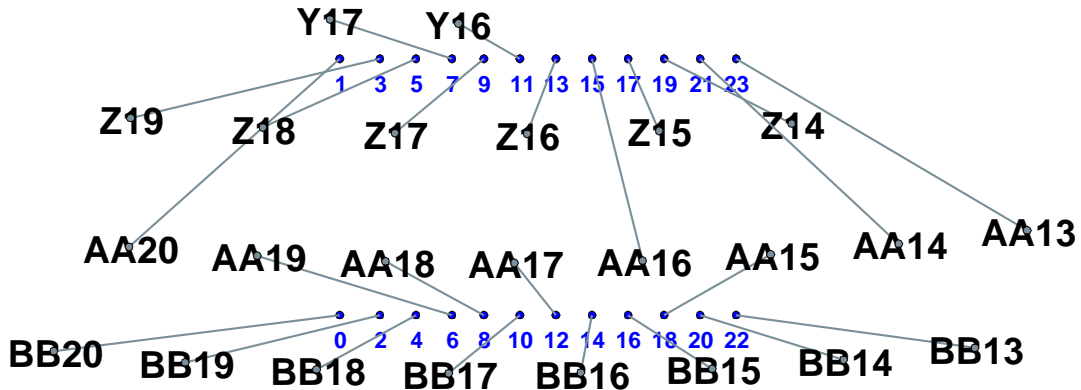

# I4

wire BB28 ( 22, 42) pad 0 distance 46mm 1.8in +2.3= 4.14in wire 4.50in  
 wire Z27 ( 24, 72) pad 1 distance 45mm 1.8in +2.3= 4.08in wire 4.50in  
 wire BB27 ( 38, 40) pad 2 distance 39mm 1.5in +2.3= 3.86in wire 4.00in  
 wire AA28 ( 31, 55) pad 3 distance 51mm 2.0in +2.3= 4.33in wire 4.50in  
 wire BB26 ( 54, 39) pad 4 distance 34mm 1.4in +2.3= 3.68in wire 3.75in  
 wire Z26 ( 41, 70) pad 5 distance 42mm 1.7in +2.3= 3.98in wire 4.00in  
 wire AA27 ( 47, 53) pad 6 distance 40mm 1.6in +2.3= 3.89in wire 4.00in  
 wire Y25 ( 50, 83) pad 7 distance 38mm 1.5in +2.3= 3.83in wire 4.00in  
 wire AA26 ( 63, 52) pad 8 distance 38mm 1.5in +2.3= 3.82in wire 4.00in  
 wire Z25 ( 57, 69) pad 9 distance 40mm 1.6in +2.3= 3.90in wire 4.00in  
 wire BB25 ( 71, 38) pad 10 distance 34mm 1.3in +2.3= 3.67in wire 3.75in  
 wire Y24 ( 66, 82) pad 11 distance 36mm 1.4in +2.3= 3.74in wire 3.75in  
 wire AA25 ( 79, 52) pad 12 distance 37mm 1.4in +2.3= 3.76in wire 4.00in  
 wire Z24 ( 74, 68) pad 13 distance 38mm 1.5in +2.3= 3.82in wire 4.00in  
 wire BB24 ( 87, 38) pad 14 distance 33mm 1.3in +2.3= 3.63in wire 3.75in  
 wire Z23 ( 90, 68) pad 15 distance 36mm 1.4in +2.3= 3.76in wire 4.00in  
 wire BB23 (104, 38) pad 16 distance 34mm 1.3in +2.3= 3.66in wire 3.75in  
 wire AA24 ( 96, 52) pad 17 distance 46mm 1.8in +2.3= 4.12in wire 4.50in  
 wire AA23 (112, 52) pad 18 distance 37mm 1.5in +2.3= 3.79in wire 4.00in  
 wire Z22 (107, 68) pad 19 distance 37mm 1.5in +2.3= 3.77in wire 4.00in  
 wire BB22 (120, 38) pad 20 distance 36mm 1.4in +2.3= 3.74in wire 3.75in  
 wire AA22 (128, 53) pad 21 distance 49mm 1.9in +2.3= 4.24in wire 4.50in  
 wire BB21 (137, 40) pad 22 distance 41mm 1.6in +2.3= 3.95in wire 4.00in  
 wire AA21 (144, 54) pad 23 distance 53mm 2.1in +2.3= 4.43in wire 4.50in

Longest wire AA21 at 112.5mm 4.43in Mean dist 99.0mm 3.90in

6 3.75-inch wires 12 4-inch wires 6 4.5-inch wires 0 5-inch wires 0 longer wires

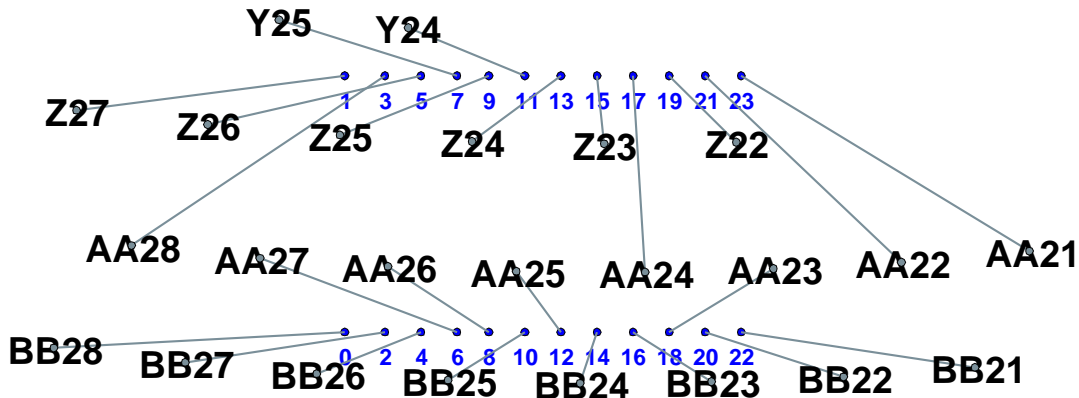

# I5

wire BB36 ( 22, 40) pad 0 distance 46mm 1.8in +2.3= 4.13in wire 4.50in  
 wire AA36 ( 32, 53) pad 1 distance 48mm 1.9in +2.3= 4.23in wire 4.50in  
 wire BB35 ( 39, 38) pad 2 distance 39mm 1.5in +2.3= 3.85in wire 4.00in  
 wire Z34 ( 33, 69) pad 3 distance 44mm 1.7in +2.3= 4.06in wire 4.50in  
 wire BB34 ( 55, 38) pad 4 distance 34mm 1.3in +2.3= 3.67in wire 3.75in  
 wire Y33 ( 42, 82) pad 5 distance 40mm 1.6in +2.3= 3.89in wire 4.00in  
 wire AA35 ( 48, 52) pad 6 distance 40mm 1.6in +2.3= 3.88in wire 4.00in  
 wire Z33 ( 50, 68) pad 7 distance 41mm 1.6in +2.3= 3.95in wire 4.00in  
 wire AA34 ( 64, 51) pad 8 distance 38mm 1.5in +2.3= 3.80in wire 4.00in  
 wire Y32 ( 58, 81) pad 9 distance 37mm 1.5in +2.3= 3.79in wire 4.00in  
 wire BB33 ( 71, 37) pad 10 distance 34mm 1.3in +2.3= 3.67in wire 3.75in  
 wire Z32 ( 66, 67) pad 11 distance 39mm 1.5in +2.3= 3.87in wire 4.00in  
 wire AA33 ( 80, 51) pad 12 distance 36mm 1.4in +2.3= 3.75in wire 3.75in  
 wire Z31 ( 82, 67) pad 13 distance 37mm 1.4in +2.3= 3.77in wire 4.00in  
 wire BB32 ( 88, 37) pad 14 distance 33mm 1.3in +2.3= 3.63in wire 3.75in  
 wire AA32 ( 96, 51) pad 15 distance 46mm 1.8in +2.3= 4.14in wire 4.50in  
 wire BB31 (104, 38) pad 16 distance 34mm 1.3in +2.3= 3.66in wire 3.75in  
 wire Z30 ( 99, 67) pad 17 distance 37mm 1.4in +2.3= 3.76in wire 4.00in  
 wire AA31 (112, 52) pad 18 distance 37mm 1.5in +2.3= 3.79in wire 4.00in  
 wire Z29 (116, 68) pad 19 distance 39mm 1.5in +2.3= 3.85in wire 4.00in  
 wire BB30 (121, 39) pad 20 distance 36mm 1.4in +2.3= 3.75in wire 3.75in  
 wire AA30 (128, 53) pad 21 distance 48mm 1.9in +2.3= 4.23in wire 4.50in  
 wire BB29 (137, 40) pad 22 distance 41mm 1.6in +2.3= 3.96in wire 4.00in  
 wire AA29 (144, 55) pad 23 distance 53mm 2.1in +2.3= 4.41in wire 4.50in

Longest wire AA29 at 112.0mm 4.41in Mean dist 98.9mm 3.90in

6 3.75-inch wires 12 4-inch wires 6 4.5-inch wires 0 5-inch wires 0 longer wires

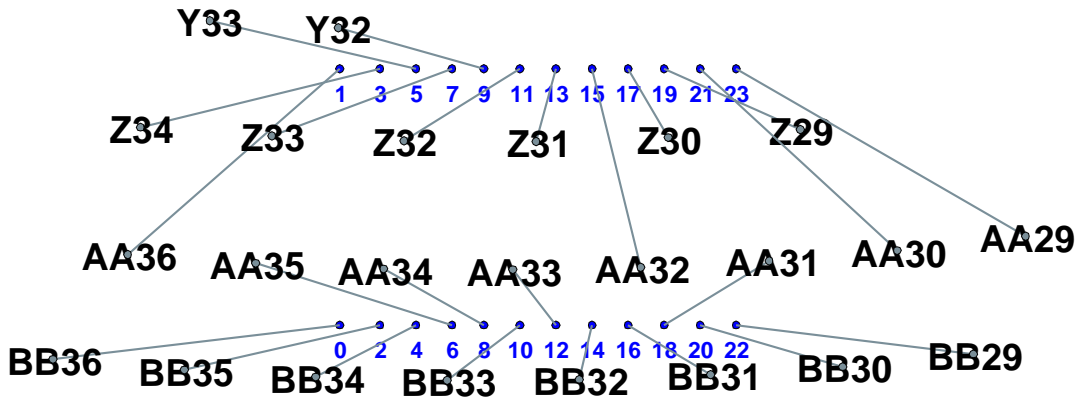



## I6

wire BB44 ( 22, 42) pad 0 distance 46mm 1.8in +2.3= 4.15in wire 4.50in  
 wire Z42 ( 26, 72) pad 1 distance 44mm 1.7in +2.3= 4.04in wire 4.50in  
 wire BB43 ( 38, 40) pad 2 distance 39mm 1.5in +2.3= 3.87in wire 4.00in  
 wire AA44 ( 31, 55) pad 3 distance 51mm 2.0in +2.3= 4.33in wire 4.50in  
 wire BB42 ( 54, 39) pad 4 distance 34mm 1.4in +2.3= 3.68in wire 3.75in  
 wire Z41 ( 42, 70) pad 5 distance 41mm 1.6in +2.3= 3.95in wire 4.00in  
 wire AA42 ( 63, 52) pad 6 distance 34mm 1.3in +2.3= 3.65in wire 3.75in  
 wire AA43 ( 47, 53) pad 7 distance 49mm 1.9in +2.3= 4.27in wire 4.50in  
 wire BB41 ( 71, 38) pad 8 distance 33mm 1.3in +2.3= 3.63in wire 3.75in  
 wire Z40 ( 59, 68) pad 9 distance 40mm 1.6in +2.3= 3.88in wire 4.00in  
 wire AA41 ( 79, 51) pad 10 distance 36mm 1.4in +2.3= 3.74in wire 3.75in  
 wire Z39 ( 75, 68) pad 11 distance 37mm 1.4in +2.3= 3.77in wire 4.00in  
 wire BB40 ( 87, 37) pad 12 distance 33mm 1.3in +2.3= 3.63in wire 3.75in  
 wire Z38 ( 92, 67) pad 13 distance 37mm 1.5in +2.3= 3.79in wire 4.00in  
 wire BB39 (104, 37) pad 14 distance 35mm 1.4in +2.3= 3.71in wire 3.75in  
 wire AA40 ( 95, 51) pad 15 distance 46mm 1.8in +2.3= 4.14in wire 4.50in  
 wire AA39 (111, 52) pad 16 distance 39mm 1.5in +2.3= 3.87in wire 4.00in  
 wire Z37 (108, 67) pad 17 distance 38mm 1.5in +2.3= 3.84in wire 4.00in  
 wire BB38 (120, 38) pad 18 distance 38mm 1.5in +2.3= 3.82in wire 4.00in  
 wire Z36 (125, 68) pad 19 distance 43mm 1.7in +2.3= 4.03in wire 4.50in  
 wire AA38 (127, 52) pad 20 distance 42mm 1.6in +2.3= 3.97in wire 4.00in  
 wire Z35 (141, 69) pad 21 distance 49mm 1.9in +2.3= 4.26in wire 4.50in  
 wire BB37 (136, 39) pad 22 distance 41mm 1.6in +2.3= 3.94in wire 4.00in  
 wire AA37 (143, 54) pad 23 distance 54mm 2.1in +2.3= 4.44in wire 4.50in

Longest wire AA37 at 112.7mm 4.44in Mean dist 99.9mm 3.93in

6 3.75-inch wires 10 4-inch wires 8 4.5-inch wires 0 5-inch wires 0 longer wires

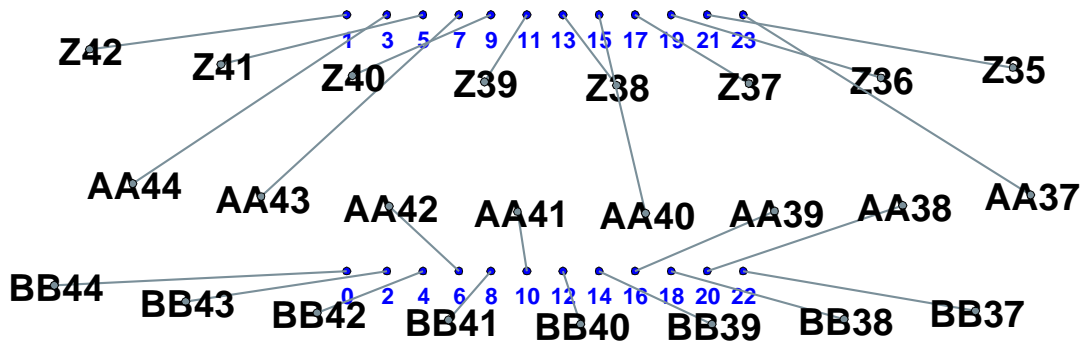

# I7

wire BB52 ( 22, 40) pad 0 distance 46mm 1.8in +2.3= 4.14in wire 4.50in  
 wire AA52 ( 31, 53) pad 1 distance 49mm 1.9in +2.3= 4.23in wire 4.50in  
 wire BB51 ( 38, 39) pad 2 distance 39mm 1.5in +2.3= 3.86in wire 4.00in  
 wire Y49 ( 27, 83) pad 3 distance 46mm 1.8in +2.3= 4.14in wire 4.50in  
 wire BB50 ( 54, 38) pad 4 distance 34mm 1.4in +2.3= 3.67in wire 3.75in  
 wire Z49 ( 34, 69) pad 5 distance 46mm 1.8in +2.3= 4.15in wire 4.50in  
 wire AA51 ( 47, 52) pad 6 distance 40mm 1.6in +2.3= 3.89in wire 4.00in  
 wire Z48 ( 51, 68) pad 7 distance 41mm 1.6in +2.3= 3.93in wire 4.00in  
 wire AA50 ( 63, 51) pad 8 distance 38mm 1.5in +2.3= 3.81in wire 4.00in  
 wire Z47 ( 67, 67) pad 9 distance 38mm 1.5in +2.3= 3.80in wire 4.00in  
 wire BB49 ( 71, 37) pad 10 distance 34mm 1.3in +2.3= 3.67in wire 3.75in  
 wire AA49 ( 79, 51) pad 11 distance 46mm 1.8in +2.3= 4.14in wire 4.50in  
 wire BB48 ( 87, 37) pad 12 distance 33mm 1.3in +2.3= 3.63in wire 3.75in  
 wire Z46 ( 84, 67) pad 13 distance 37mm 1.4in +2.3= 3.77in wire 4.00in  
 wire AA48 ( 95, 51) pad 14 distance 36mm 1.4in +2.3= 3.75in wire 3.75in  
 wire Z45 (100, 67) pad 15 distance 38mm 1.5in +2.3= 3.82in wire 4.00in  
 wire BB47 (104, 38) pad 16 distance 34mm 1.3in +2.3= 3.66in wire 3.75in  
 wire AA47 (111, 52) pad 17 distance 48mm 1.9in +2.3= 4.21in wire 4.50in  
 wire BB46 (120, 38) pad 18 distance 38mm 1.5in +2.3= 3.83in wire 4.00in  
 wire Z44 (116, 68) pad 19 distance 39mm 1.5in +2.3= 3.87in wire 4.00in  
 wire AA46 (127, 53) pad 20 distance 42mm 1.7in +2.3= 3.98in wire 4.00in  
 wire Z43 (133, 70) pad 21 distance 44mm 1.7in +2.3= 4.05in wire 4.50in  
 wire BB45 (137, 40) pad 22 distance 41mm 1.6in +2.3= 3.94in wire 4.00in  
 wire AA45 (143, 55) pad 23 distance 53mm 2.1in +2.3= 4.41in wire 4.50in

Longest wire AA45 at 112.0mm 4.41in Mean dist 99.8mm 3.93in

5 3.75-inch wires 11 4-inch wires 8 4.5-inch wires 0 5-inch wires 0 longer wires

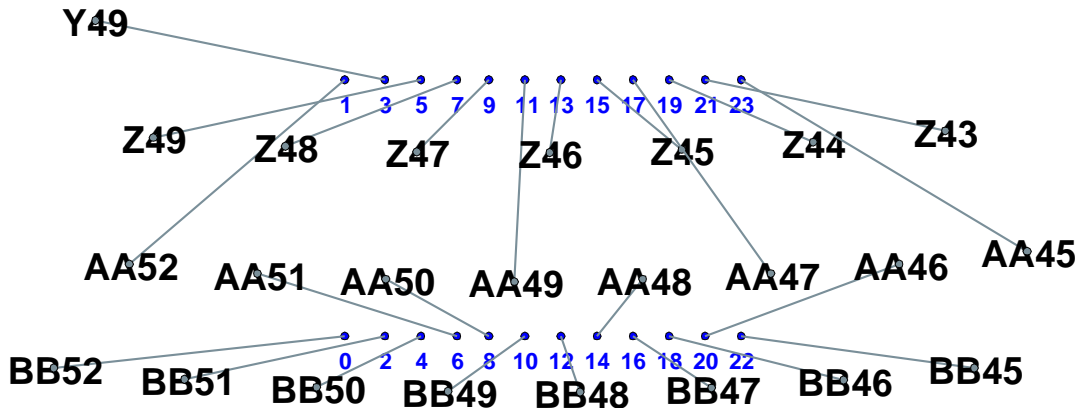

# I8

wire BB60 ( 22, 42) pad 0 distance 46mm 1.8in +2.3= 4.14in wire 4.50in  
 wire Z57 ( 27, 71) pad 1 distance 43mm 1.7in +2.3= 4.01in wire 4.50in  
 wire BB59 ( 38, 40) pad 2 distance 39mm 1.5in +2.3= 3.86in wire 4.00in  
 wire AA60 ( 32, 55) pad 3 distance 51mm 2.0in +2.3= 4.33in wire 4.50in  
 wire BB58 ( 54, 39) pad 4 distance 34mm 1.4in +2.3= 3.68in wire 3.75in  
 wire Z56 ( 44, 69) pad 5 distance 41mm 1.6in +2.3= 3.92in wire 4.00in  
 wire AA58 ( 64, 52) pad 6 distance 34mm 1.3in +2.3= 3.65in wire 3.75in  
 wire AA59 ( 48, 53) pad 7 distance 50mm 1.9in +2.3= 4.27in wire 4.50in  
 wire BB57 ( 71, 38) pad 8 distance 33mm 1.3in +2.3= 3.63in wire 3.75in  
 wire Z55 ( 60, 68) pad 9 distance 39mm 1.5in +2.3= 3.86in wire 4.00in  
 wire AA57 ( 80, 51) pad 10 distance 36mm 1.4in +2.3= 3.74in wire 3.75in  
 wire Z54 ( 77, 67) pad 11 distance 37mm 1.4in +2.3= 3.77in wire 4.00in  
 wire BB56 ( 87, 37) pad 12 distance 33mm 1.3in +2.3= 3.63in wire 3.75in  
 wire Z53 ( 93, 67) pad 13 distance 38mm 1.5in +2.3= 3.80in wire 4.00in  
 wire BB55 (104, 37) pad 14 distance 35mm 1.4in +2.3= 3.72in wire 3.75in  
 wire AA56 ( 96, 51) pad 15 distance 46mm 1.8in +2.3= 4.15in wire 4.50in  
 wire AA55 (112, 51) pad 16 distance 39mm 1.5in +2.3= 3.87in wire 4.00in  
 wire Z52 (110, 67) pad 17 distance 39mm 1.5in +2.3= 3.86in wire 4.00in  
 wire BB54 (120, 38) pad 18 distance 38mm 1.5in +2.3= 3.83in wire 4.00in  
 wire Z51 (126, 68) pad 19 distance 44mm 1.7in +2.3= 4.06in wire 4.50in  
 wire AA54 (128, 52) pad 20 distance 42mm 1.7in +2.3= 3.97in wire 4.00in  
 wire Z50 (143, 69) pad 21 distance 50mm 2.0in +2.3= 4.30in wire 4.50in  
 wire BB53 (137, 39) pad 22 distance 41mm 1.6in +2.3= 3.95in wire 4.00in  
 wire AA53 (144, 53) pad 23 distance 54mm 2.1in +2.3= 4.44in wire 4.50in

Longest wire AA53 at 112.9mm 4.44in Mean dist 99.9mm 3.93in

6 3.75-inch wires 10 4-inch wires 8 4.5-inch wires 0 5-inch wires 0 longer wires

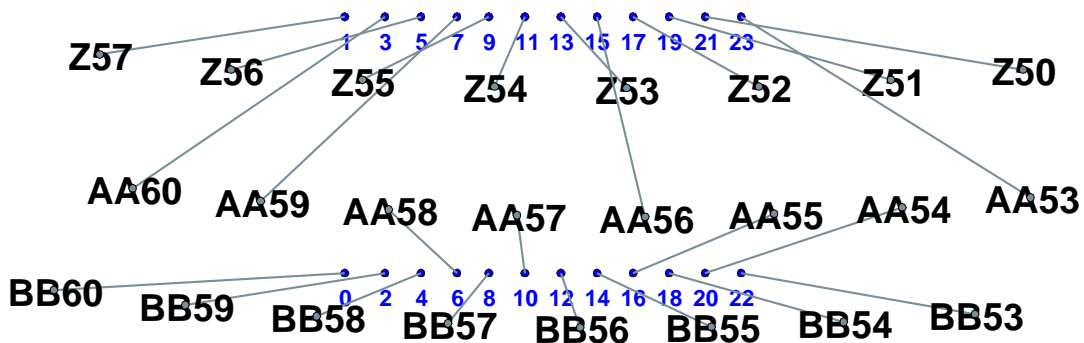

I9

wire BB68 ( 22, 41) pad 0 distance 46mm 1.8in +2.3= 4.14in wire 4.50in  
 wire AA68 ( 32, 54) pad 1 distance 48mm 1.9in +2.3= 4.20in wire 4.50in  
 wire BB67 ( 38, 40) pad 2 distance 39mm 1.5in +2.3= 3.86in wire 4.00in  
 wire AA67 ( 48, 53) pad 3 distance 46mm 1.8in +2.3= 4.12in wire 4.50in  
 wire BB66 ( 55, 38) pad 4 distance 34mm 1.3in +2.3= 3.67in wire 3.75in  
 wire Z63 ( 52, 68) pad 5 distance 38mm 1.5in +2.3= 3.80in wire 4.00in  
 wire AA66 ( 64, 52) pad 6 distance 34mm 1.3in +2.3= 3.65in wire 3.75in  
 wire Z62 ( 69, 67) pad 7 distance 37mm 1.4in +2.3= 3.76in wire 4.00in  
 wire BB65 ( 71, 38) pad 8 distance 33mm 1.3in +2.3= 3.63in wire 3.75in  
 wire AA65 ( 80, 51) pad 9 distance 46mm 1.8in +2.3= 4.14in wire 4.50in  
 wire BB64 ( 88, 37) pad 10 distance 34mm 1.3in +2.3= 3.66in wire 3.75in  
 wire Z61 ( 86, 67) pad 11 distance 37mm 1.5in +2.3= 3.78in wire 4.00in  
 wire AA64 ( 96, 51) pad 12 distance 37mm 1.5in +2.3= 3.80in wire 4.00in  
 wire Z60 (102, 67) pad 13 distance 40mm 1.6in +2.3= 3.91in wire 4.00in  
 wire BB63 (104, 37) pad 14 distance 35mm 1.4in +2.3= 3.72in wire 3.75in  
 wire Y59 (109, 81) pad 15 distance 38mm 1.5in +2.3= 3.83in wire 4.00in  
 wire AA63 (112, 52) pad 16 distance 39mm 1.5in +2.3= 3.87in wire 4.00in  
 wire Z59 (118, 68) pad 17 distance 43mm 1.7in +2.3= 4.00in wire 4.50in  
 wire BB62 (120, 38) pad 18 distance 38mm 1.5in +2.3= 3.83in wire 4.00in  
 wire Y58 (125, 82) pad 19 distance 41mm 1.6in +2.3= 3.94in wire 4.00in  
 wire AA62 (128, 52) pad 20 distance 42mm 1.7in +2.3= 3.98in wire 4.00in  
 wire Z58 (135, 69) pad 21 distance 45mm 1.8in +2.3= 4.10in wire 4.50in  
 wire BB61 (137, 39) pad 22 distance 41mm 1.6in +2.3= 3.95in wire 4.00in  
 wire AA61 (144, 54) pad 23 distance 54mm 2.1in +2.3= 4.43in wire 4.50in

Longest wire AA61 at 112.6mm 4.43in Mean dist 99.2mm 3.91in

5 3.75-inch wires 12 4-inch wires 7 4.5-inch wires 0 5-inch wires 0 longer wires

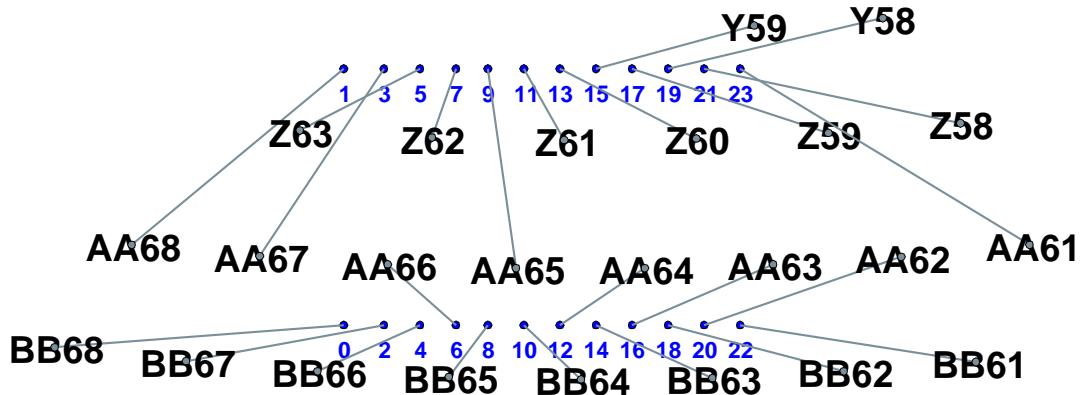

# I10

wire BB76 ( 24, 39) pad 0 distance 45mm 1.8in +2.3= 4.09in wire 4.50in  
 wire AA77 ( 17, 54) pad 1 distance 56mm 2.2in +2.3= 4.52in wire 5.00in  
 wire BB75 ( 40, 38) pad 2 distance 38mm 1.5in +2.3= 3.82in wire 4.00in  
 wire AA76 ( 33, 52) pad 3 distance 52mm 2.0in +2.3= 4.35in wire 4.50in  
 wire BB74 ( 56, 37) pad 4 distance 34mm 1.3in +2.3= 3.66in wire 3.75in  
 wire AA75 ( 49, 51) pad 5 distance 48mm 1.9in +2.3= 4.19in wire 4.50in  
 wire AA74 ( 65, 51) pad 6 distance 33mm 1.3in +2.3= 3.64in wire 3.75in  
 wire Z70 ( 62, 67) pad 7 distance 37mm 1.5in +2.3= 3.79in wire 4.00in  
 wire BB73 ( 73, 37) pad 8 distance 33mm 1.3in +2.3= 3.62in wire 3.75in  
 wire Z69 ( 79, 67) pad 9 distance 37mm 1.5in +2.3= 3.78in wire 4.00in  
 wire BB72 ( 89, 37) pad 10 distance 34mm 1.3in +2.3= 3.67in wire 3.75in  
 wire AA73 ( 81, 51) pad 11 distance 46mm 1.8in +2.3= 4.14in wire 4.50in  
 wire AA72 ( 97, 51) pad 12 distance 38mm 1.5in +2.3= 3.81in wire 4.00in  
 wire Z68 ( 96, 67) pad 13 distance 38mm 1.5in +2.3= 3.82in wire 4.00in  
 wire BB71 (106, 38) pad 14 distance 36mm 1.4in +2.3= 3.75in wire 3.75in  
 wire Y67 (102, 81) pad 15 distance 35mm 1.4in +2.3= 3.71in wire 3.75in  
 wire AA71 (113, 52) pad 16 distance 40mm 1.6in +2.3= 3.90in wire 4.00in  
 wire Z67 (112, 68) pad 17 distance 40mm 1.6in +2.3= 3.88in wire 4.00in  
 wire BB70 (122, 39) pad 18 distance 39mm 1.5in +2.3= 3.87in wire 4.00in  
 wire Y66 (119, 82) pad 19 distance 37mm 1.5in +2.3= 3.80in wire 4.00in  
 wire AA70 (129, 53) pad 20 distance 43mm 1.7in +2.3= 4.02in wire 4.50in  
 wire Z66 (128, 69) pad 21 distance 41mm 1.6in +2.3= 3.95in wire 4.00in  
 wire BB69 (139, 40) pad 22 distance 42mm 1.7in +2.3= 3.99in wire 4.00in  
 wire AA69 (145, 55) pad 23 distance 54mm 2.1in +2.3= 4.44in wire 4.50in

Longest wire AA77 at 114.9mm 4.52in Mean dist 99.7mm 3.93in

6 3.75-inch wires 11 4-inch wires 6 4.5-inch wires 1 5-inch wires 0 longer wires

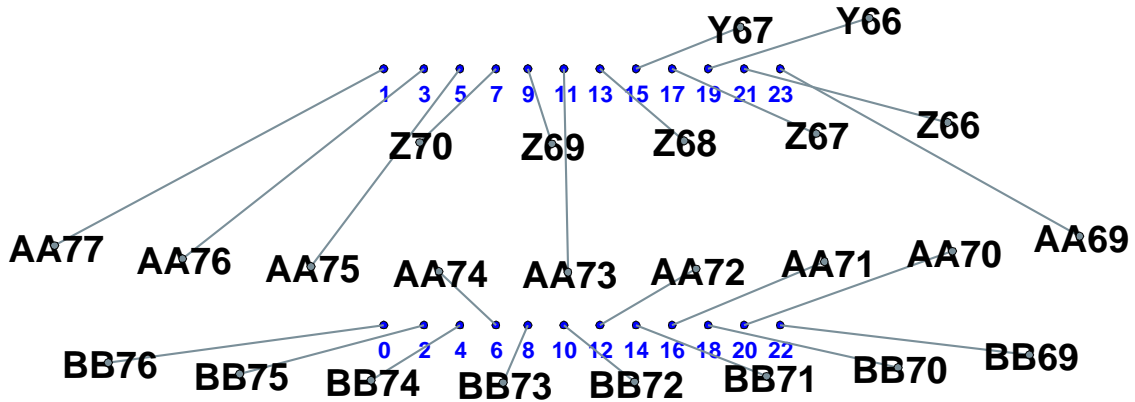

# I11

wire BB84 ( 22, 42) pad 0 distance 46mm 1.8in +2.3= 4.14in wire 4.50in  
 wire AA85 ( 16, 56) pad 1 distance 56mm 2.2in +2.3= 4.51in wire 5.00in  
 wire BB83 ( 38, 40) pad 2 distance 39mm 1.5in +2.3= 3.86in wire 4.00in  
 wire AA84 ( 32, 54) pad 3 distance 51mm 2.0in +2.3= 4.33in wire 4.50in  
 wire BB82 ( 55, 38) pad 4 distance 34mm 1.4in +2.3= 3.67in wire 3.75in  
 wire AA83 ( 48, 53) pad 5 distance 47mm 1.9in +2.3= 4.18in wire 4.50in  
 wire AA82 ( 64, 52) pad 6 distance 34mm 1.3in +2.3= 3.65in wire 3.75in  
 wire Z78 ( 54, 68) pad 7 distance 39mm 1.5in +2.3= 3.86in wire 4.00in  
 wire BB81 ( 71, 38) pad 8 distance 33mm 1.3in +2.3= 3.63in wire 3.75in  
 wire Z77 ( 70, 68) pad 9 distance 37mm 1.4in +2.3= 3.77in wire 4.00in  
 wire AA81 ( 80, 51) pad 10 distance 36mm 1.4in +2.3= 3.74in wire 3.75in  
 wire Z76 ( 87, 67) pad 11 distance 37mm 1.5in +2.3= 3.79in wire 4.00in  
 wire BB80 ( 87, 37) pad 12 distance 33mm 1.3in +2.3= 3.63in wire 3.75in  
 wire Y75 ( 95, 81) pad 13 distance 34mm 1.4in +2.3= 3.68in wire 3.75in  
 wire AA80 ( 96, 51) pad 14 distance 36mm 1.4in +2.3= 3.75in wire 3.75in  
 wire Z75 (104, 67) pad 15 distance 39mm 1.5in +2.3= 3.86in wire 4.00in  
 wire BB79 (104, 37) pad 16 distance 34mm 1.3in +2.3= 3.66in wire 3.75in  
 wire Y74 (111, 81) pad 17 distance 36mm 1.4in +2.3= 3.75in wire 3.75in  
 wire AA79 (112, 51) pad 18 distance 37mm 1.5in +2.3= 3.79in wire 4.00in  
 wire Z74 (120, 68) pad 19 distance 41mm 1.6in +2.3= 3.93in wire 4.00in  
 wire BB78 (120, 38) pad 20 distance 36mm 1.4in +2.3= 3.74in wire 3.75in  
 wire AA78 (128, 52) pad 21 distance 49mm 1.9in +2.3= 4.25in wire 4.50in  
 wire BB77 (137, 39) pad 22 distance 41mm 1.6in +2.3= 3.95in wire 4.00in  
 wire Z73 (136, 69) pad 23 distance 43mm 1.7in +2.3= 4.02in wire 4.50in

Longest wire AA85 at 114.6mm 4.51in Mean dist 98.6mm 3.88in

10 3.75-inch wires 8 4-inch wires 5 4.5-inch wires 1 5-inch wires 0 longer wires

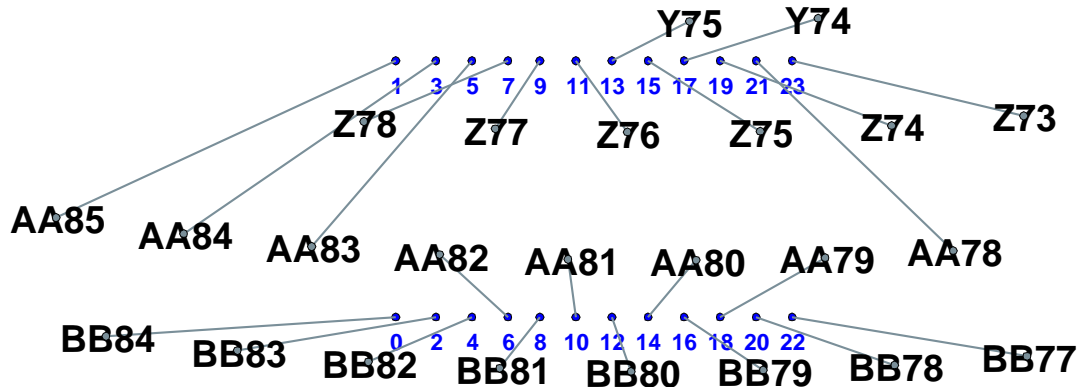

## I12

wire BB92 ( 26, 38) pad 0 distance 44mm 1.7in +2.3= 4.04in wire 4.50in  
 wire AA93 ( 19, 52) pad 1 distance 56mm 2.2in +2.3= 4.52in wire 5.00in  
 wire BB91 ( 42, 37) pad 2 distance 37mm 1.5in +2.3= 3.79in wire 4.00in  
 wire AA92 ( 35, 51) pad 3 distance 51mm 2.0in +2.3= 4.35in wire 4.50in  
 wire BB90 ( 58, 36) pad 4 distance 34mm 1.3in +2.3= 3.64in wire 3.75in  
 wire AA91 ( 51, 50) pad 5 distance 48mm 1.9in +2.3= 4.20in wire 4.50in  
 wire AA90 ( 67, 50) pad 6 distance 33mm 1.3in +2.3= 3.63in wire 3.75in  
 wire Z86 ( 49, 66) pad 7 distance 42mm 1.7in +2.3= 3.98in wire 4.00in  
 wire BB89 ( 75, 36) pad 8 distance 33mm 1.3in +2.3= 3.62in wire 3.75in  
 wire Z85 ( 65, 66) pad 9 distance 38mm 1.5in +2.3= 3.84in wire 4.00in  
 wire AA89 ( 83, 50) pad 10 distance 36mm 1.4in +2.3= 3.72in wire 3.75in  
 wire Z84 ( 82, 66) pad 11 distance 37mm 1.5in +2.3= 3.79in wire 4.00in  
 wire BB88 ( 91, 36) pad 12 distance 34mm 1.3in +2.3= 3.65in wire 3.75in  
 wire Y83 ( 89, 80) pad 13 distance 33mm 1.3in +2.3= 3.64in wire 3.75in  
 wire AA88 ( 99, 51) pad 14 distance 37mm 1.4in +2.3= 3.76in wire 4.00in  
 wire Z83 ( 98, 67) pad 15 distance 38mm 1.5in +2.3= 3.81in wire 4.00in  
 wire BB87 (108, 37) pad 16 distance 35mm 1.4in +2.3= 3.70in wire 3.75in  
 wire Y82 (105, 81) pad 17 distance 34mm 1.4in +2.3= 3.67in wire 3.75in  
 wire AA87 (115, 52) pad 18 distance 38mm 1.5in +2.3= 3.83in wire 4.00in  
 wire Z82 (115, 68) pad 19 distance 39mm 1.5in +2.3= 3.85in wire 4.00in  
 wire BB86 (124, 39) pad 20 distance 38mm 1.5in +2.3= 3.81in wire 4.00in  
 wire AA86 (131, 54) pad 21 distance 50mm 2.0in +2.3= 4.28in wire 4.50in  
 wire BB85 (140, 41) pad 22 distance 44mm 1.7in +2.3= 4.04in wire 4.50in  
 wire Z81 (131, 70) pad 23 distance 40mm 1.6in +2.3= 3.90in wire 4.00in

Longest wire AA93 at 114.7mm 4.52in Mean dist 98.5mm 3.88in

8 3.75-inch wires 10 4-inch wires 5 4.5-inch wires 1 5-inch wires 0 longer wires

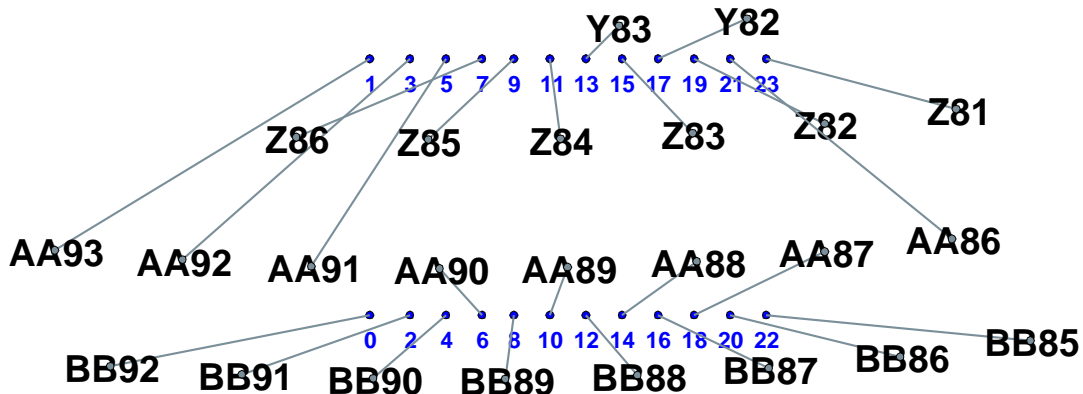

### I13

wire BB101 ( 18, 38) pad 0 distance 49mm 1.9in +2.3= 4.26in wire 4.50in  
 wire AA101 ( 27, 51) pad 1 distance 52mm 2.0in +2.3= 4.37in wire 4.50in  
 wire BB100 ( 34, 36) pad 2 distance 41mm 1.6in +2.3= 3.96in wire 4.00in  
 wire AA100 ( 43, 50) pad 3 distance 49mm 1.9in +2.3= 4.24in wire 4.50in  
 wire BB99 ( 50, 36) pad 4 distance 36mm 1.4in +2.3= 3.73in wire 3.75in  
 wire Z94 ( 49, 66) pad 5 distance 40mm 1.6in +2.3= 3.89in wire 4.00in  
 wire AA99 ( 59, 50) pad 6 distance 35mm 1.4in +2.3= 3.69in wire 3.75in  
 wire Z93 ( 65, 66) pad 7 distance 37mm 1.5in +2.3= 3.80in wire 4.00in  
 wire BB98 ( 67, 36) pad 8 distance 34mm 1.3in +2.3= 3.66in wire 3.75in  
 wire AA98 ( 75, 50) pad 9 distance 47mm 1.8in +2.3= 4.16in wire 4.50in  
 wire BB97 ( 83, 36) pad 10 distance 33mm 1.3in +2.3= 3.63in wire 3.75in  
 wire Z92 ( 82, 66) pad 11 distance 37mm 1.5in +2.3= 3.78in wire 4.00in  
 wire AA97 ( 91, 51) pad 12 distance 36mm 1.4in +2.3= 3.75in wire 3.75in  
 wire Y91 ( 89, 80) pad 13 distance 33mm 1.3in +2.3= 3.63in wire 3.75in  
 wire BB96 (100, 37) pad 14 distance 34mm 1.3in +2.3= 3.67in wire 3.75in  
 wire Z91 ( 98, 67) pad 15 distance 37mm 1.5in +2.3= 3.80in wire 4.00in  
 wire AA96 (107, 52) pad 16 distance 38mm 1.5in +2.3= 3.81in wire 4.00in  
 wire Y90 (105, 82) pad 17 distance 34mm 1.3in +2.3= 3.67in wire 3.75in  
 wire BB95 (116, 39) pad 18 distance 36mm 1.4in +2.3= 3.75in wire 4.00in  
 wire Z90 (115, 69) pad 19 distance 38mm 1.5in +2.3= 3.84in wire 4.00in  
 wire BB94 (132, 41) pad 20 distance 42mm 1.7in +2.3= 3.99in wire 4.00in  
 wire AA95 (123, 54) pad 21 distance 46mm 1.8in +2.3= 4.15in wire 4.50in  
 wire BB93 (149, 43) pad 22 distance 50mm 2.0in +2.3= 4.27in wire 4.50in  
 wire AA94 (138, 56) pad 23 distance 50mm 2.0in +2.3= 4.29in wire 4.50in

Longest wire AA101 at 111.0mm 4.37in Mean dist 99.2mm 3.91in

8 3.75-inch wires 9 4-inch wires 7 4.5-inch wires 0 5-inch wires 0 longer wires

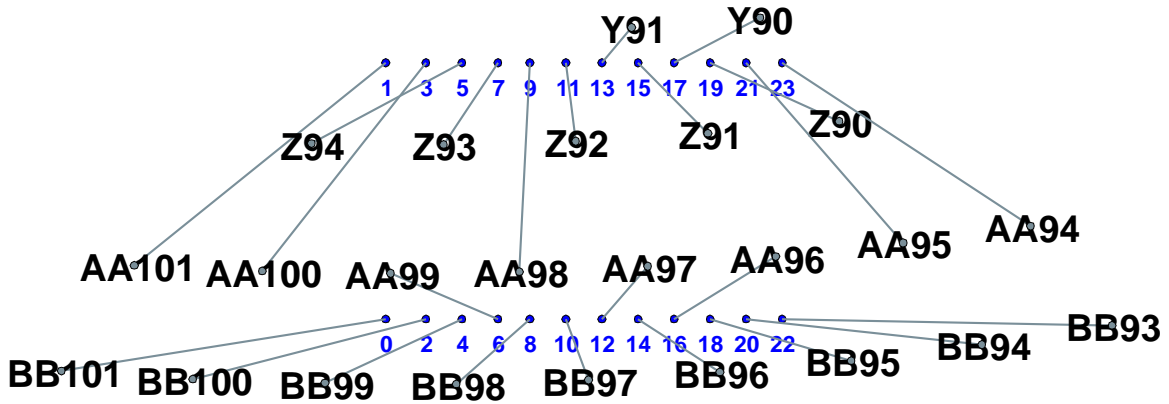



# I14

wire BB109 ( 22, 41) pad 0 distance 46mm 1.8in +2.3= 4.13in wire 4.50in  
 wire AA109 ( 32, 54) pad 1 distance 48mm 1.9in +2.3= 4.21in wire 4.50in  
 wire BB108 ( 38, 39) pad 2 distance 39mm 1.5in +2.3= 3.86in wire 4.00in  
 wire Z102 ( 47, 68) pad 3 distance 38mm 1.5in +2.3= 3.81in wire 4.00in  
 wire BB107 ( 55, 38) pad 4 distance 34mm 1.3in +2.3= 3.67in wire 3.75in  
 wire AA108 ( 48, 52) pad 5 distance 47mm 1.9in +2.3= 4.19in wire 4.50in  
 wire AA107 ( 64, 52) pad 6 distance 34mm 1.3in +2.3= 3.65in wire 3.75in  
 wire Z101 ( 63, 68) pad 7 distance 37mm 1.5in +2.3= 3.77in wire 4.00in  
 wire BB106 ( 71, 38) pad 8 distance 33mm 1.3in +2.3= 3.63in wire 3.75in  
 wire Z100 ( 80, 67) pad 9 distance 37mm 1.4in +2.3= 3.77in wire 4.00in  
 wire AA106 ( 80, 51) pad 10 distance 36mm 1.4in +2.3= 3.74in wire 3.75in  
 wire Y99 ( 87, 81) pad 11 distance 34mm 1.3in +2.3= 3.65in wire 3.75in  
 wire BB105 ( 88, 38) pad 12 distance 33mm 1.3in +2.3= 3.63in wire 3.75in  
 wire Z99 ( 96, 68) pad 13 distance 38mm 1.5in +2.3= 3.82in wire 4.00in  
 wire AA105 ( 96, 52) pad 14 distance 36mm 1.4in +2.3= 3.75in wire 4.00in  
 wire Y98 (103, 82) pad 15 distance 36mm 1.4in +2.3= 3.72in wire 3.75in  
 wire BB104 (104, 38) pad 16 distance 34mm 1.3in +2.3= 3.66in wire 3.75in  
 wire Z98 (112, 68) pad 17 distance 40mm 1.6in +2.3= 3.89in wire 4.00in  
 wire AA104 (112, 52) pad 18 distance 37mm 1.5in +2.3= 3.80in wire 4.00in  
 wire Z97 (129, 70) pad 19 distance 45mm 1.8in +2.3= 4.11in wire 4.50in  
 wire BB103 (121, 39) pad 20 distance 36mm 1.4in +2.3= 3.74in wire 3.75in  
 wire AA103 (128, 53) pad 21 distance 48mm 1.9in +2.3= 4.23in wire 4.50in  
 wire BB102 (137, 40) pad 22 distance 41mm 1.6in +2.3= 3.95in wire 4.00in  
 wire AA102 (144, 55) pad 23 distance 53mm 2.1in +2.3= 4.41in wire 4.50in

Longest wire AA102 at 112.1mm 4.41in Mean dist 98.2mm 3.87in

9 3.75-inch wires 9 4-inch wires 6 4.5-inch wires 0 5-inch wires 0 longer wires

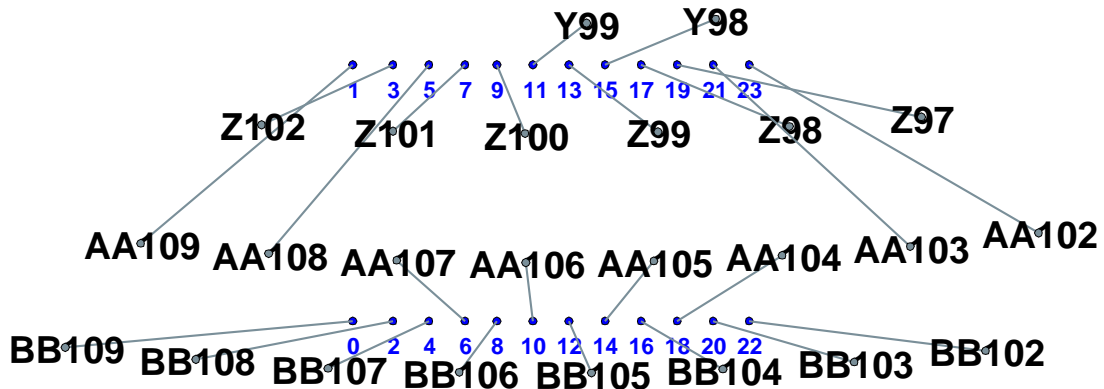

# I15

wire BB117 ( 22, 42) pad 0 distance 46mm 1.8in +2.3= 4.15in wire 4.50in  
 wire AA117 ( 32, 55) pad 1 distance 47mm 1.9in +2.3= 4.19in wire 4.50in  
 wire BB116 ( 38, 40) pad 2 distance 39mm 1.5in +2.3= 3.87in wire 4.00in  
 wire AA116 ( 47, 53) pad 3 distance 45mm 1.8in +2.3= 4.11in wire 4.50in  
 wire BB115 ( 54, 38) pad 4 distance 34mm 1.4in +2.3= 3.68in wire 3.75in  
 wire Z109 ( 56, 68) pad 5 distance 37mm 1.4in +2.3= 3.77in wire 4.00in  
 wire AA115 ( 63, 52) pad 6 distance 34mm 1.3in +2.3= 3.65in wire 3.75in  
 wire Z108 ( 72, 67) pad 7 distance 37mm 1.4in +2.3= 3.77in wire 4.00in  
 wire BB114 ( 71, 37) pad 8 distance 33mm 1.3in +2.3= 3.63in wire 3.75in  
 wire Y107 ( 81, 81) pad 9 distance 34mm 1.3in +2.3= 3.64in wire 3.75in  
 wire AA114 ( 79, 51) pad 10 distance 36mm 1.4in +2.3= 3.73in wire 3.75in  
 wire Z107 ( 89, 67) pad 11 distance 38mm 1.5in +2.3= 3.82in wire 4.00in  
 wire BB113 ( 87, 37) pad 12 distance 33mm 1.3in +2.3= 3.62in wire 3.75in  
 wire X99 ( 90, 96) pad 13 distance 36mm 1.4in +2.3= 3.74in wire 3.75in  
 wire AA113 ( 96, 50) pad 14 distance 36mm 1.4in +2.3= 3.74in wire 3.75in  
 wire Y106 ( 97, 80) pad 15 distance 34mm 1.3in +2.3= 3.65in wire 3.75in  
 wire BB112 (104, 37) pad 16 distance 34mm 1.3in +2.3= 3.66in wire 3.75in  
 wire Z106 (105, 66) pad 17 distance 38mm 1.5in +2.3= 3.82in wire 4.00in  
 wire AA112 (112, 51) pad 18 distance 37mm 1.5in +2.3= 3.77in wire 4.00in  
 wire Z105 (122, 67) pad 19 distance 42mm 1.7in +2.3= 3.98in wire 4.00in  
 wire BB111 (120, 37) pad 20 distance 36mm 1.4in +2.3= 3.74in wire 3.75in  
 wire AA111 (128, 51) pad 21 distance 50mm 2.0in +2.3= 4.27in wire 4.50in  
 wire BB110 (136, 38) pad 22 distance 41mm 1.6in +2.3= 3.94in wire 4.00in  
 wire AA110 (144, 52) pad 23 distance 54mm 2.1in +2.3= 4.47in wire 4.50in

Longest wire AA110 at 113.4mm 4.47in Mean dist 97.8mm 3.85in

11 3.75-inch wires 8 4-inch wires 5 4.5-inch wires 0 5-inch wires 0 longer wires

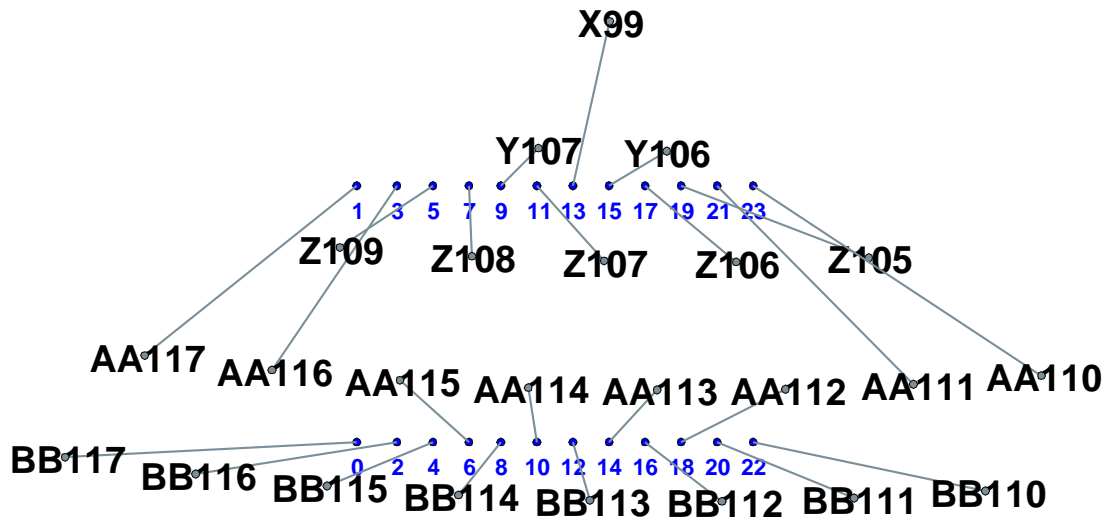

# I16

wire BB125 ( 22, 40) pad 0 distance 46mm 1.8in +2.3= 4.14in wire 4.50in  
 wire AA125 ( 31, 53) pad 1 distance 48mm 1.9in +2.3= 4.23in wire 4.50in  
 wire BB124 ( 38, 39) pad 2 distance 39mm 1.5in +2.3= 3.86in wire 4.00in  
 wire AA124 ( 47, 52) pad 3 distance 46mm 1.8in +2.3= 4.14in wire 4.50in  
 wire BB123 ( 55, 38) pad 4 distance 34mm 1.3in +2.3= 3.67in wire 3.75in  
 wire Z117 ( 48, 68) pad 5 distance 39mm 1.6in +2.3= 3.88in wire 4.00in  
 wire AA123 ( 63, 51) pad 6 distance 34mm 1.3in +2.3= 3.65in wire 3.75in  
 wire Y116 ( 56, 81) pad 7 distance 36mm 1.4in +2.3= 3.72in wire 3.75in  
 wire BB122 ( 71, 37) pad 8 distance 33mm 1.3in +2.3= 3.63in wire 3.75in  
 wire Z116 ( 64, 67) pad 9 distance 38mm 1.5in +2.3= 3.83in wire 4.00in  
 wire AA122 ( 79, 51) pad 10 distance 36mm 1.4in +2.3= 3.74in wire 3.75in  
 wire Y115 ( 72, 81) pad 11 distance 34mm 1.3in +2.3= 3.66in wire 3.75in  
 wire BB121 ( 88, 37) pad 12 distance 33mm 1.3in +2.3= 3.63in wire 3.75in  
 wire Z115 ( 80, 67) pad 13 distance 37mm 1.5in +2.3= 3.78in wire 4.00in  
 wire AA121 ( 95, 51) pad 14 distance 36mm 1.4in +2.3= 3.75in wire 3.75in  
 wire Y114 ( 88, 81) pad 15 distance 33mm 1.3in +2.3= 3.63in wire 3.75in  
 wire BB120 (104, 38) pad 16 distance 34mm 1.3in +2.3= 3.66in wire 3.75in  
 wire Z114 ( 97, 68) pad 17 distance 36mm 1.4in +2.3= 3.76in wire 4.00in  
 wire AA120 (111, 52) pad 18 distance 37mm 1.5in +2.3= 3.80in wire 4.00in  
 wire Z113 (114, 68) pad 19 distance 38mm 1.5in +2.3= 3.83in wire 4.00in  
 wire BB119 (120, 39) pad 20 distance 36mm 1.4in +2.3= 3.74in wire 3.75in  
 wire AA119 (127, 54) pad 21 distance 48mm 1.9in +2.3= 4.22in wire 4.50in  
 wire BB118 (137, 41) pad 22 distance 41mm 1.6in +2.3= 3.95in wire 4.00in  
 wire AA118 (143, 55) pad 23 distance 53mm 2.1in +2.3= 4.40in wire 4.50in

Longest wire AA118 at 111.7mm 4.40in Mean dist 97.7mm 3.84in

11 3.75-inch wires 8 4-inch wires 5 4.5-inch wires 0 5-inch wires 0 longer wires

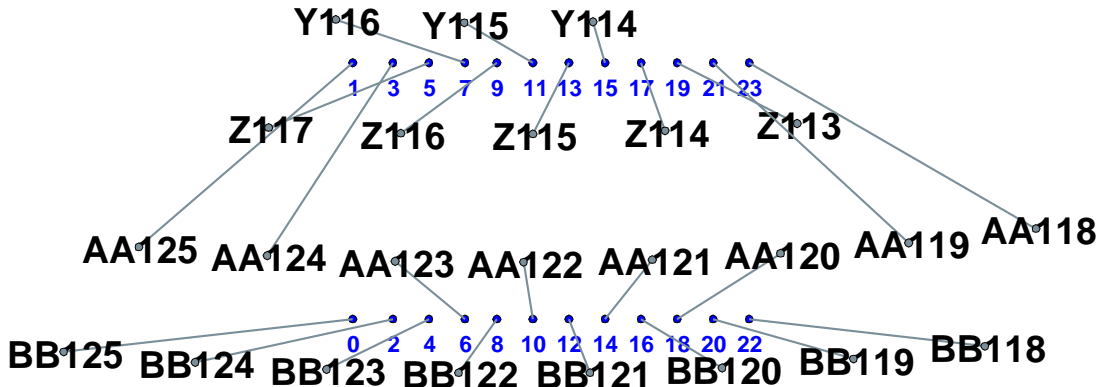

# I17

wire BB133 ( 22, 42) pad 0 distance 46mm 1.8in +2.3= 4.15in wire 4.50in  
 wire AA133 ( 32, 55) pad 1 distance 47mm 1.9in +2.3= 4.18in wire 4.50in  
 wire BB132 ( 38, 40) pad 2 distance 39mm 1.5in +2.3= 3.87in wire 4.00in  
 wire Z125 ( 41, 70) pad 3 distance 40mm 1.6in +2.3= 3.88in wire 4.00in  
 wire BB131 ( 54, 39) pad 4 distance 34mm 1.4in +2.3= 3.68in wire 3.75in  
 wire Y124 ( 50, 83) pad 5 distance 36mm 1.4in +2.3= 3.73in wire 3.75in  
 wire AA132 ( 48, 53) pad 6 distance 40mm 1.6in +2.3= 3.89in wire 4.00in  
 wire Z124 ( 57, 68) pad 7 distance 38mm 1.5in +2.3= 3.82in wire 4.00in  
 wire AA131 ( 64, 52) pad 8 distance 38mm 1.5in +2.3= 3.82in wire 4.00in  
 wire Y123 ( 66, 82) pad 9 distance 34mm 1.3in +2.3= 3.67in wire 3.75in  
 wire BB130 ( 71, 38) pad 10 distance 34mm 1.3in +2.3= 3.67in wire 3.75in  
 wire Z123 ( 74, 67) pad 11 distance 37mm 1.5in +2.3= 3.78in wire 4.00in  
 wire AA130 ( 80, 51) pad 12 distance 36mm 1.4in +2.3= 3.75in wire 3.75in  
 wire Y122 ( 82, 81) pad 13 distance 33mm 1.3in +2.3= 3.63in wire 3.75in  
 wire BB129 ( 87, 37) pad 14 distance 33mm 1.3in +2.3= 3.63in wire 3.75in  
 wire Z122 ( 90, 67) pad 15 distance 37mm 1.4in +2.3= 3.77in wire 4.00in  
 wire BB128 (104, 37) pad 16 distance 34mm 1.3in +2.3= 3.66in wire 3.75in  
 wire AA129 ( 96, 51) pad 17 distance 46mm 1.8in +2.3= 4.14in wire 4.50in  
 wire AA128 (112, 51) pad 18 distance 37mm 1.5in +2.3= 3.78in wire 4.00in  
 wire Z121 (107, 67) pad 19 distance 37mm 1.5in +2.3= 3.79in wire 4.00in  
 wire BB127 (120, 37) pad 20 distance 36mm 1.4in +2.3= 3.74in wire 3.75in  
 wire AA127 (128, 52) pad 21 distance 49mm 1.9in +2.3= 4.27in wire 4.50in  
 wire BB126 (137, 38) pad 22 distance 41mm 1.6in +2.3= 3.94in wire 4.00in  
 wire AA126 (144, 53) pad 23 distance 54mm 2.1in +2.3= 4.46in wire 4.50in

Longest wire AA126 at 113.3mm 4.46in Mean dist 98.1mm 3.86in

9 3.75-inch wires 10 4-inch wires 5 4.5-inch wires 0 5-inch wires 0 longer wires

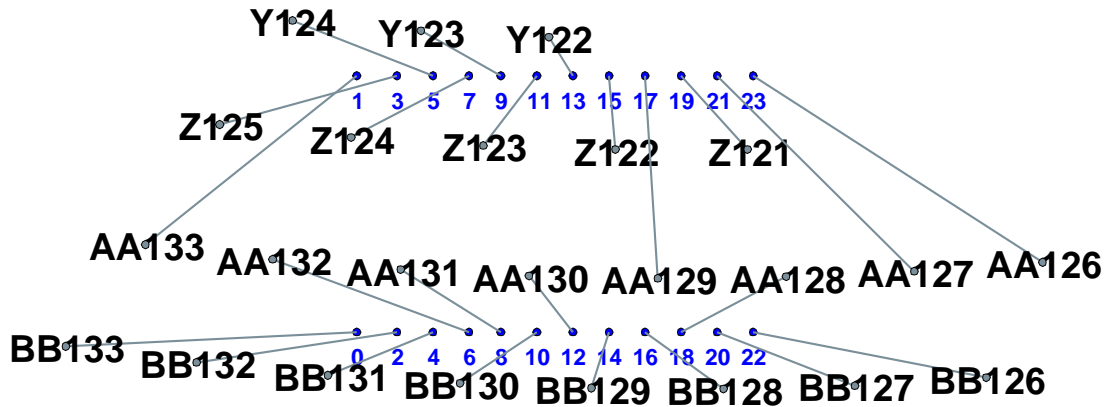

# I18

wire BB141 ( 21, 39) pad 0 distance 46mm 1.8in +2.3= 4.15in wire 4.50in  
 wire AA141 ( 31, 52) pad 1 distance 49mm 1.9in +2.3= 4.26in wire 4.50in  
 wire BB140 ( 38, 38) pad 2 distance 39mm 1.5in +2.3= 3.87in wire 4.00in  
 wire Z133 ( 32, 68) pad 3 distance 45mm 1.8in +2.3= 4.10in wire 4.50in  
 wire BB139 ( 54, 37) pad 4 distance 34mm 1.4in +2.3= 3.68in wire 3.75in  
 wire Z132 ( 48, 67) pad 5 distance 39mm 1.6in +2.3= 3.88in wire 4.00in  
 wire AA140 ( 47, 51) pad 6 distance 40mm 1.6in +2.3= 3.90in wire 4.00in  
 wire Y131 ( 56, 81) pad 7 distance 35mm 1.4in +2.3= 3.72in wire 3.75in  
 wire AA139 ( 63, 51) pad 8 distance 38mm 1.5in +2.3= 3.81in wire 4.00in  
 wire Z131 ( 64, 67) pad 9 distance 38mm 1.5in +2.3= 3.82in wire 4.00in  
 wire BB138 ( 71, 37) pad 10 distance 34mm 1.3in +2.3= 3.67in wire 3.75in  
 wire Y130 ( 72, 81) pad 11 distance 34mm 1.3in +2.3= 3.66in wire 3.75in  
 wire AA138 ( 79, 51) pad 12 distance 36mm 1.4in +2.3= 3.76in wire 4.00in  
 wire Z130 ( 81, 67) pad 13 distance 37mm 1.5in +2.3= 3.77in wire 4.00in  
 wire BB137 ( 87, 37) pad 14 distance 33mm 1.3in +2.3= 3.63in wire 3.75in  
 wire AA137 ( 95, 52) pad 15 distance 46mm 1.8in +2.3= 4.13in wire 4.50in  
 wire BB136 (104, 38) pad 16 distance 34mm 1.3in +2.3= 3.66in wire 3.75in  
 wire Z129 ( 98, 68) pad 17 distance 36mm 1.4in +2.3= 3.76in wire 4.00in  
 wire AA136 (111, 52) pad 18 distance 37mm 1.5in +2.3= 3.79in wire 4.00in  
 wire Z128 (114, 69) pad 19 distance 38mm 1.5in +2.3= 3.83in wire 4.00in  
 wire BB135 (120, 39) pad 20 distance 36mm 1.4in +2.3= 3.74in wire 3.75in  
 wire AA135 (127, 54) pad 21 distance 48mm 1.9in +2.3= 4.19in wire 4.50in  
 wire BB134 (136, 41) pad 22 distance 41mm 1.6in +2.3= 3.94in wire 4.00in  
 wire AA134 (143, 56) pad 23 distance 52mm 2.0in +2.3= 4.37in wire 4.50in

Longest wire AA134 at 111.0mm 4.37in Mean dist 98.5mm 3.88in

7 3.75-inch wires 11 4-inch wires 6 4.5-inch wires 0 5-inch wires 0 longer wires

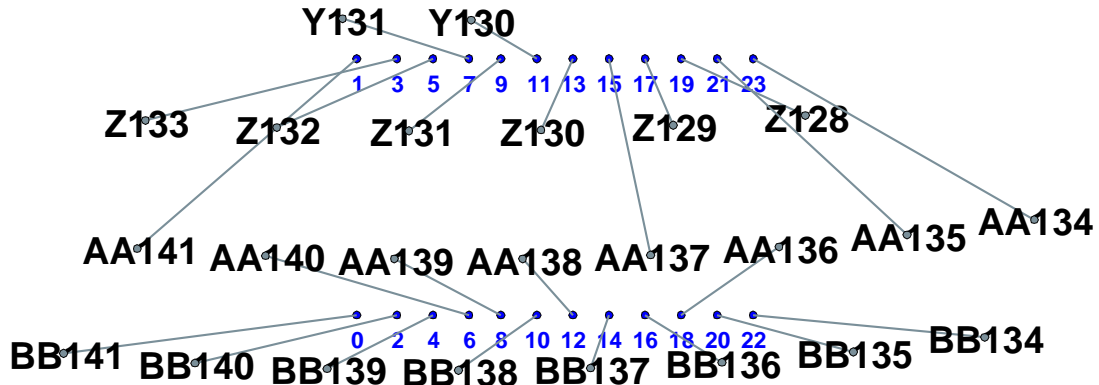

wire BB149 ( 22, 42) pad 0 distance 46mm 1.8in +2.3= 4.15in wire 4.50in  
 wire Z141 ( 26, 72) pad 1 distance 44mm 1.7in +2.3= 4.05in wire 4.50in  
 wire BB148 ( 38, 40) pad 2 distance 39mm 1.5in +2.3= 3.86in wire 4.00in  
 wire AA149 ( 32, 55) pad 3 distance 51mm 2.0in +2.3= 4.32in wire 4.50in  
 wire BB147 ( 54, 39) pad 4 distance 34mm 1.4in +2.3= 3.68in wire 3.75in  
 wire Z140 ( 42, 70) pad 5 distance 41mm 1.6in +2.3= 3.95in wire 4.00in  
 wire AA148 ( 48, 53) pad 6 distance 40mm 1.6in +2.3= 3.89in wire 4.00in  
 wire Y139 ( 51, 83) pad 7 distance 37mm 1.5in +2.3= 3.80in wire 4.00in  
 wire AA147 ( 64, 52) pad 8 distance 38mm 1.5in +2.3= 3.82in wire 4.00in  
 wire Z139 ( 59, 68) pad 9 distance 40mm 1.6in +2.3= 3.88in wire 4.00in  
 wire BB146 ( 71, 38) pad 10 distance 34mm 1.3in +2.3= 3.67in wire 3.75in  
 wire Z138 ( 75, 67) pad 11 distance 37mm 1.4in +2.3= 3.77in wire 4.00in  
 wire BB145 ( 87, 37) pad 12 distance 33mm 1.3in +2.3= 3.63in wire 3.75in  
 wire AA146 ( 80, 51) pad 13 distance 46mm 1.8in +2.3= 4.14in wire 4.50in  
 wire AA145 ( 96, 51) pad 14 distance 36mm 1.4in +2.3= 3.74in wire 3.75in  
 wire Z137 ( 92, 67) pad 15 distance 37mm 1.4in +2.3= 3.77in wire 4.00in  
 wire BB144 (104, 37) pad 16 distance 34mm 1.3in +2.3= 3.66in wire 3.75in  
 wire Z136 (108, 67) pad 17 distance 39mm 1.5in +2.3= 3.84in wire 4.00in  
 wire AA144 (112, 51) pad 18 distance 37mm 1.5in +2.3= 3.78in wire 4.00in  
 wire Z135 (125, 68) pad 19 distance 43mm 1.7in +2.3= 4.03in wire 4.50in  
 wire BB143 (120, 38) pad 20 distance 36mm 1.4in +2.3= 3.74in wire 3.75in  
 wire AA143 (128, 52) pad 21 distance 49mm 1.9in +2.3= 4.26in wire 4.50in  
 wire BB142 (137, 38) pad 22 distance 41mm 1.6in +2.3= 3.95in wire 4.00in  
 wire AA142 (144, 53) pad 23 distance 54mm 2.1in +2.3= 4.45in wire 4.50in

Longest wire AA142 at 113.1mm 4.45in Mean dist 99.3mm 3.91in

6 3.75-inch wires 11 4-inch wires 7 4.5-inch wires 0 5-inch wires 0 longer wires

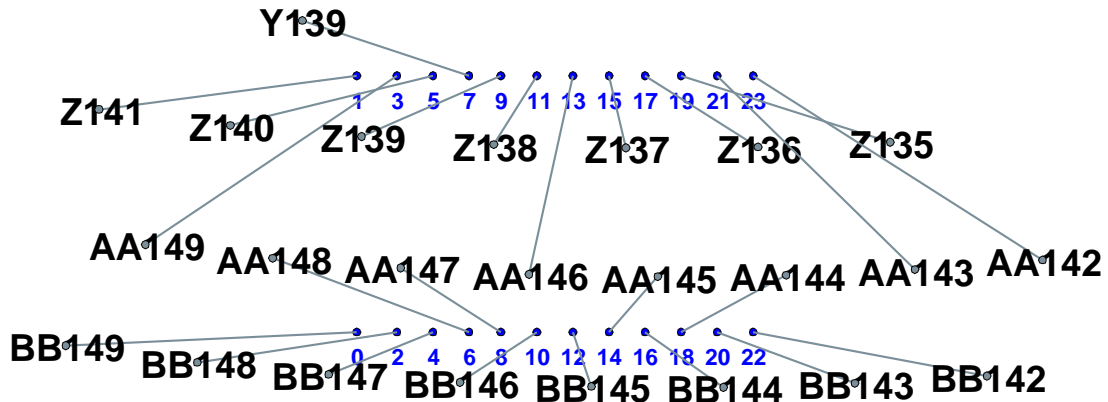

wire BB157 ( 21, 39) pad 0 distance 47mm 1.8in +2.3= 4.17in wire 4.50in  
 wire AA157 ( 30, 52) pad 1 distance 50mm 2.0in +2.3= 4.28in wire 4.50in  
 wire BB156 ( 37, 37) pad 2 distance 40mm 1.6in +2.3= 3.88in wire 4.00in  
 wire Z148 ( 32, 68) pad 3 distance 45mm 1.8in +2.3= 4.09in wire 4.50in  
 wire BB155 ( 54, 37) pad 4 distance 35mm 1.4in +2.3= 3.69in wire 3.75in  
 wire Y147 ( 40, 81) pad 5 distance 41mm 1.6in +2.3= 3.92in wire 4.00in  
 wire AA156 ( 46, 51) pad 6 distance 40mm 1.6in +2.3= 3.92in wire 4.00in  
 wire Z147 ( 48, 67) pad 7 distance 42mm 1.7in +2.3= 3.98in wire 4.00in  
 wire AA155 ( 62, 50) pad 8 distance 38mm 1.5in +2.3= 3.82in wire 4.00in  
 wire Z146 ( 65, 66) pad 9 distance 38mm 1.5in +2.3= 3.83in wire 4.00in  
 wire BB154 ( 70, 37) pad 10 distance 35mm 1.4in +2.3= 3.68in wire 3.75in  
 wire AA154 ( 78, 51) pad 11 distance 46mm 1.8in +2.3= 4.15in wire 4.50in  
 wire BB153 ( 86, 37) pad 12 distance 33mm 1.3in +2.3= 3.62in wire 3.75in  
 wire Z145 ( 82, 67) pad 13 distance 37mm 1.5in +2.3= 3.78in wire 4.00in  
 wire AA153 ( 94, 51) pad 14 distance 36mm 1.4in +2.3= 3.74in wire 3.75in  
 wire Z144 ( 98, 68) pad 15 distance 37mm 1.5in +2.3= 3.79in wire 4.00in  
 wire BB152 (103, 38) pad 16 distance 34mm 1.3in +2.3= 3.65in wire 3.75in  
 wire Z143 (114, 69) pad 17 distance 40mm 1.6in +2.3= 3.91in wire 4.00in  
 wire AA152 (110, 52) pad 18 distance 37mm 1.5in +2.3= 3.78in wire 4.00in  
 wire AA151 (126, 54) pad 19 distance 51mm 2.0in +2.3= 4.32in wire 4.50in  
 wire BB151 (119, 39) pad 20 distance 36mm 1.4in +2.3= 3.72in wire 3.75in  
 wire Z142 (131, 70) pad 21 distance 42mm 1.7in +2.3= 3.99in wire 4.00in  
 wire BB150 (136, 41) pad 22 distance 41mm 1.6in +2.3= 3.92in wire 4.00in  
 wire AA150 (142, 56) pad 23 distance 52mm 2.0in +2.3= 4.35in wire 4.50in

Longest wire AA150 at 110.6mm 4.35in Mean dist 99.5mm 3.92in

6 3.75-inch wires 12 4-inch wires 6 4.5-inch wires 0 5-inch wires 0 longer wires

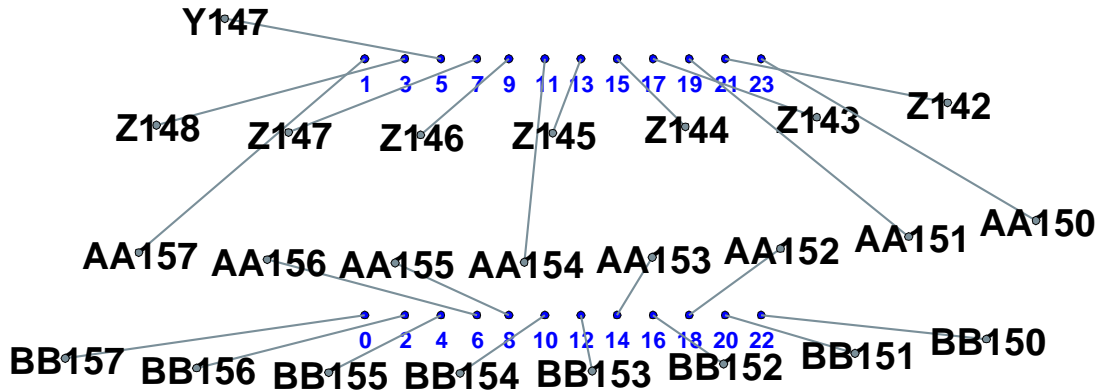

## I21

wire BB165 ( 23, 42) pad 0 distance 46mm 1.8in +2.3= 4.12in wire 4.50in  
 wire Z156 ( 28, 72) pad 1 distance 43mm 1.7in +2.3= 4.00in wire 4.00in  
 wire BB164 ( 39, 40) pad 2 distance 39mm 1.5in +2.3= 3.85in wire 4.00in  
 wire AA165 ( 32, 55) pad 3 distance 50mm 2.0in +2.3= 4.30in wire 4.50in  
 wire BB163 ( 55, 39) pad 4 distance 34mm 1.3in +2.3= 3.67in wire 3.75in  
 wire Z155 ( 44, 70) pad 5 distance 40mm 1.6in +2.3= 3.91in wire 4.00in  
 wire AA163 ( 64, 52) pad 6 distance 34mm 1.3in +2.3= 3.65in wire 3.75in  
 wire AA164 ( 48, 53) pad 7 distance 49mm 1.9in +2.3= 4.25in wire 4.50in  
 wire BB162 ( 72, 38) pad 8 distance 33mm 1.3in +2.3= 3.63in wire 3.75in  
 wire Z154 ( 61, 68) pad 9 distance 39mm 1.5in +2.3= 3.85in wire 4.00in  
 wire AA162 ( 80, 51) pad 10 distance 36mm 1.4in +2.3= 3.74in wire 3.75in  
 wire Z153 ( 77, 68) pad 11 distance 37mm 1.4in +2.3= 3.76in wire 4.00in  
 wire BB161 ( 88, 37) pad 12 distance 33mm 1.3in +2.3= 3.63in wire 3.75in  
 wire Z152 ( 94, 67) pad 13 distance 38mm 1.5in +2.3= 3.80in wire 4.00in  
 wire BB160 (105, 38) pad 14 distance 36mm 1.4in +2.3= 3.73in wire 3.75in  
 wire AA161 ( 96, 51) pad 15 distance 46mm 1.8in +2.3= 4.14in wire 4.50in  
 wire AA160 (112, 52) pad 16 distance 40mm 1.6in +2.3= 3.88in wire 4.00in  
 wire Z151 (110, 68) pad 17 distance 39mm 1.5in +2.3= 3.86in wire 4.00in  
 wire BB159 (121, 38) pad 18 distance 39mm 1.5in +2.3= 3.84in wire 4.00in  
 wire Z150 (127, 68) pad 19 distance 44mm 1.7in +2.3= 4.07in wire 4.50in  
 wire AA159 (128, 52) pad 20 distance 42mm 1.7in +2.3= 3.99in wire 4.00in  
 wire Z149 (143, 70) pad 21 distance 50mm 2.0in +2.3= 4.31in wire 4.50in  
 wire BB158 (138, 39) pad 22 distance 42mm 1.6in +2.3= 3.96in wire 4.00in  
 wire AA158 (144, 54) pad 23 distance 54mm 2.1in +2.3= 4.46in wire 4.50in

Longest wire AA158 at 113.4mm 4.46in Mean dist 99.9mm 3.93in

6 3.75-inch wires 11 4-inch wires 7 4.5-inch wires 0 5-inch wires 0 longer wires

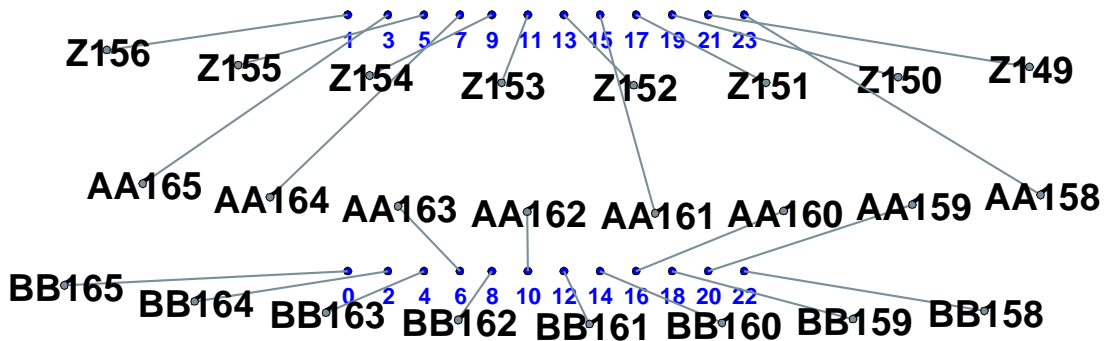



## I22

wire BB173 ( 20, 38) pad 0 distance 47mm 1.9in +2.3= 4.18in wire 4.50in  
wire AA173 ( 29, 52) pad 1 distance 50mm 2.0in +2.3= 4.30in wire 4.50in  
wire BB172 ( 37, 37) pad 2 distance 40mm 1.6in +2.3= 3.89in wire 4.00in  
wire Y163 ( 25, 82) pad 3 distance 47mm 1.9in +2.3= 4.18in wire 4.50in  
wire BB171 ( 53, 37) pad 4 distance 35mm 1.4in +2.3= 3.69in wire 3.75in  
wire Z163 ( 33, 67) pad 5 distance 48mm 1.9in +2.3= 4.20in wire 4.50in  
wire AA172 ( 45, 51) pad 6 distance 41mm 1.6in +2.3= 3.93in wire 4.00in  
wire Z162 ( 49, 67) pad 7 distance 42mm 1.6in +2.3= 3.97in wire 4.00in  
wire AA171 ( 61, 50) pad 8 distance 38mm 1.5in +2.3= 3.83in wire 4.00in  
wire Z161 ( 66, 66) pad 9 distance 38mm 1.5in +2.3= 3.82in wire 4.00in  
wire BB170 ( 70, 36) pad 10 distance 35mm 1.4in +2.3= 3.69in wire 3.75in  
wire AA170 ( 77, 50) pad 11 distance 46mm 1.8in +2.3= 4.15in wire 4.50in  
wire BB169 ( 86, 37) pad 12 distance 33mm 1.3in +2.3= 3.62in wire 3.75in  
wire Z160 ( 82, 67) pad 13 distance 37mm 1.5in +2.3= 3.78in wire 4.00in  
wire AA169 ( 93, 51) pad 14 distance 36mm 1.4in +2.3= 3.74in wire 3.75in  
wire Z159 ( 99, 68) pad 15 distance 38mm 1.5in +2.3= 3.80in wire 4.00in  
wire BB168 (102, 38) pad 16 distance 34mm 1.3in +2.3= 3.65in wire 3.75in  
wire Z158 (115, 69) pad 17 distance 41mm 1.6in +2.3= 3.93in wire 4.00in  
wire AA168 (109, 52) pad 18 distance 37mm 1.5in +2.3= 3.78in wire 4.00in  
wire AA167 (125, 54) pad 19 distance 50mm 2.0in +2.3= 4.31in wire 4.50in  
wire BB167 (119, 39) pad 20 distance 35mm 1.4in +2.3= 3.72in wire 3.75in  
wire Z157 (132, 71) pad 21 distance 43mm 1.7in +2.3= 4.01in wire 4.50in  
wire BB166 (135, 41) pad 22 distance 40mm 1.6in +2.3= 3.91in wire 4.00in  
wire AA166 (141, 56) pad 23 distance 51mm 2.0in +2.3= 4.34in wire 4.50in

Longest wire AA166 at 110.3mm 4.34in Mean dist 99.9mm 3.93in

6 3.75-inch wires 10 4-inch wires 8 4.5-inch wires 0 5-inch wires 0 longer wires

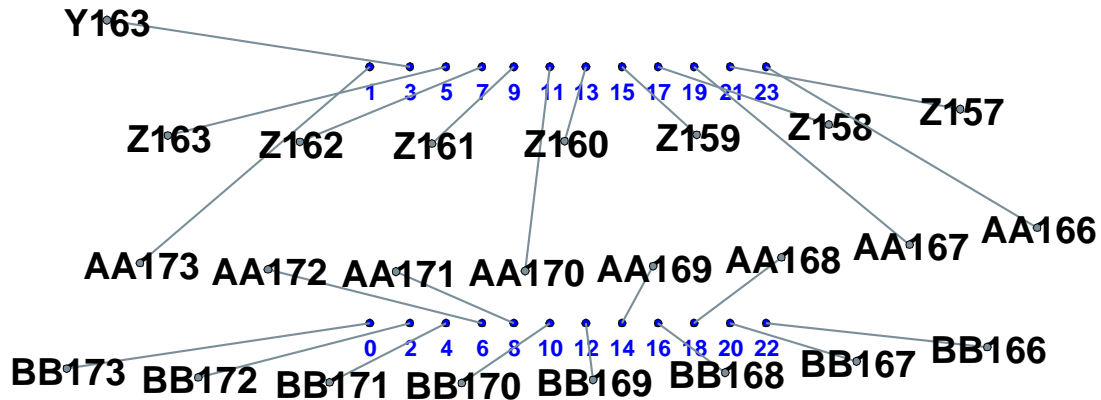

# I23

wire BB181 ( 22, 42) pad 0 distance 46mm 1.8in +2.3= 4.13in wire 4.50in  
wire Z171 ( 28, 71) pad 1 distance 42mm 1.7in +2.3= 3.99in wire 4.00in  
wire BB180 ( 38, 40) pad 2 distance 39mm 1.5in +2.3= 3.86in wire 4.00in  
wire AA181 ( 32, 54) pad 3 distance 51mm 2.0in +2.3= 4.33in wire 4.50in  
wire BB179 ( 55, 38) pad 4 distance 34mm 1.3in +2.3= 3.67in wire 3.75in  
wire AA180 ( 48, 53) pad 5 distance 47mm 1.8in +2.3= 4.17in wire 4.50in  
wire AA179 ( 64, 52) pad 6 distance 34mm 1.3in +2.3= 3.65in wire 3.75in  
wire Z170 ( 45, 69) pad 7 distance 43mm 1.7in +2.3= 4.02in wire 4.50in  
wire BB178 ( 71, 38) pad 8 distance 33mm 1.3in +2.3= 3.63in wire 3.75in  
wire Z169 ( 61, 68) pad 9 distance 39mm 1.5in +2.3= 3.85in wire 4.00in  
wire AA178 ( 80, 51) pad 10 distance 36mm 1.4in +2.3= 3.74in wire 3.75in  
wire Z168 ( 78, 67) pad 11 distance 37mm 1.4in +2.3= 3.76in wire 4.00in  
wire BB177 ( 88, 37) pad 12 distance 33mm 1.3in +2.3= 3.63in wire 3.75in  
wire Z167 ( 94, 67) pad 13 distance 38mm 1.5in +2.3= 3.81in wire 4.00in  
wire BB176 (104, 38) pad 14 distance 36mm 1.4in +2.3= 3.72in wire 3.75in  
wire AA177 ( 96, 51) pad 15 distance 46mm 1.8in +2.3= 4.14in wire 4.50in  
wire AA176 (112, 52) pad 16 distance 39mm 1.6in +2.3= 3.87in wire 4.00in  
wire Z166 (111, 68) pad 17 distance 39mm 1.5in +2.3= 3.87in wire 4.00in  
wire BB175 (121, 38) pad 18 distance 38mm 1.5in +2.3= 3.83in wire 4.00in  
wire Z165 (127, 69) pad 19 distance 45mm 1.8in +2.3= 4.08in wire 4.50in  
wire AA175 (128, 52) pad 20 distance 42mm 1.7in +2.3= 3.98in wire 4.00in  
wire Z164 (144, 70) pad 21 distance 51mm 2.0in +2.3= 4.32in wire 4.50in  
wire BB174 (137, 39) pad 22 distance 41mm 1.6in +2.3= 3.95in wire 4.00in  
wire AA174 (144, 54) pad 23 distance 54mm 2.1in +2.3= 4.44in wire 4.50in

Longest wire AA174 at 112.8mm 4.44in Mean dist 100.0mm 3.94in

6 3.75-inch wires 10 4-inch wires 8 4.5-inch wires 0 5-inch wires 0 longer wires

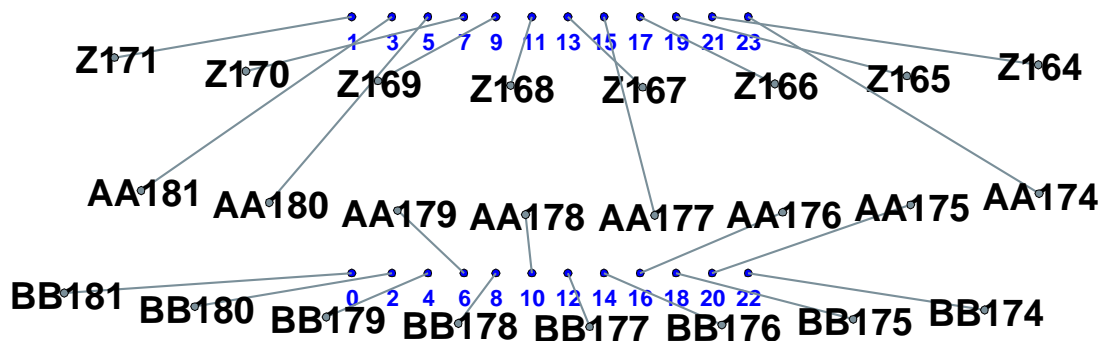

wire BB189 ( 22, 41) pad 0 distance 46mm 1.8in +2.3= 4.13in wire 4.50in  
 wire AA189 ( 32, 54) pad 1 distance 48mm 1.9in +2.3= 4.19in wire 4.50in  
 wire BB188 ( 38, 40) pad 2 distance 39mm 1.5in +2.3= 3.86in wire 4.00in  
 wire Z178 ( 37, 70) pad 3 distance 41mm 1.6in +2.3= 3.95in wire 4.00in  
 wire BB187 ( 55, 38) pad 4 distance 34mm 1.3in +2.3= 3.67in wire 3.75in  
 wire AA188 ( 48, 53) pad 5 distance 47mm 1.9in +2.3= 4.17in wire 4.50in  
 wire AA187 ( 64, 52) pad 6 distance 34mm 1.3in +2.3= 3.65in wire 3.75in  
 wire Z177 ( 54, 68) pad 7 distance 39mm 1.5in +2.3= 3.87in wire 4.00in  
 wire BB186 ( 71, 38) pad 8 distance 33mm 1.3in +2.3= 3.63in wire 3.75in  
 wire Z176 ( 70, 68) pad 9 distance 37mm 1.4in +2.3= 3.77in wire 4.00in  
 wire AA186 ( 80, 51) pad 10 distance 36mm 1.4in +2.3= 3.74in wire 3.75in  
 wire Z175 ( 87, 67) pad 11 distance 37mm 1.5in +2.3= 3.79in wire 4.00in  
 wire BB185 ( 88, 37) pad 12 distance 33mm 1.3in +2.3= 3.63in wire 3.75in  
 wire AA185 ( 96, 51) pad 13 distance 47mm 1.9in +2.3= 4.18in wire 4.50in  
 wire BB184 (104, 38) pad 14 distance 36mm 1.4in +2.3= 3.72in wire 3.75in  
 wire Z174 (103, 67) pad 15 distance 39mm 1.5in +2.3= 3.85in wire 4.00in  
 wire AA184 (112, 52) pad 16 distance 39mm 1.6in +2.3= 3.87in wire 4.00in  
 wire Z173 (120, 68) pad 17 distance 43mm 1.7in +2.3= 4.03in wire 4.50in  
 wire BB183 (121, 38) pad 18 distance 38mm 1.5in +2.3= 3.83in wire 4.00in  
 wire Y172 (126, 82) pad 19 distance 42mm 1.6in +2.3= 3.96in wire 4.00in  
 wire AA183 (128, 52) pad 20 distance 42mm 1.7in +2.3= 3.98in wire 4.00in  
 wire Z172 (136, 69) pad 21 distance 46mm 1.8in +2.3= 4.13in wire 4.50in  
 wire BB182 (137, 39) pad 22 distance 41mm 1.6in +2.3= 3.96in wire 4.00in  
 wire AA182 (144, 54) pad 23 distance 54mm 2.1in +2.3= 4.44in wire 4.50in

Longest wire AA182 at 112.7mm 4.44in Mean dist 99.5mm 3.92in

6 3.75-inch wires 11 4-inch wires 7 4.5-inch wires 0 5-inch wires 0 longer wires

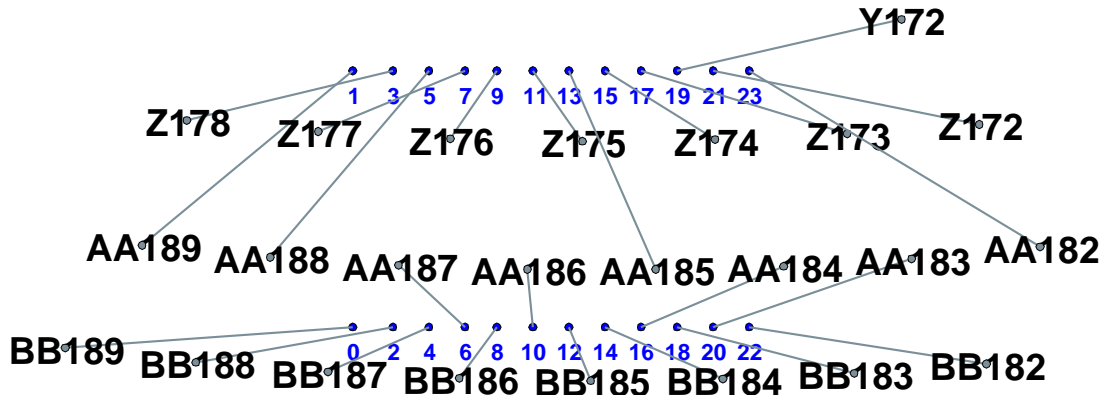

I25

wire BB197 ( 22, 41) pad 0 distance 46mm 1.8in +2.3= 4.13in wire 4.50in  
 wire AA197 ( 32, 54) pad 1 distance 48mm 1.9in +2.3= 4.20in wire 4.50in  
 wire BB196 ( 39, 39) pad 2 distance 39mm 1.5in +2.3= 3.85in wire 4.00in  
 wire AA196 ( 48, 53) pad 3 distance 46mm 1.8in +2.3= 4.12in wire 4.50in  
 wire BB195 ( 55, 38) pad 4 distance 34mm 1.3in +2.3= 3.67in wire 3.75in  
 wire AA195 ( 64, 52) pad 5 distance 45mm 1.8in +2.3= 4.08in wire 4.50in  
 wire AA194 ( 80, 51) pad 6 distance 35mm 1.4in +2.3= 3.70in wire 3.75in  
 wire Z184 ( 62, 68) pad 7 distance 37mm 1.5in +2.3= 3.77in wire 4.00in  
 wire BB194 ( 72, 38) pad 8 distance 33mm 1.3in +2.3= 3.63in wire 3.75in  
 wire Z183 ( 79, 67) pad 9 distance 37mm 1.4in +2.3= 3.77in wire 4.00in  
 wire BB193 ( 88, 38) pad 10 distance 34mm 1.3in +2.3= 3.66in wire 3.75in  
 wire Y182 ( 87, 81) pad 11 distance 34mm 1.3in +2.3= 3.65in wire 3.75in  
 wire AA193 ( 96, 52) pad 12 distance 38mm 1.5in +2.3= 3.81in wire 4.00in  
 wire Z182 ( 96, 68) pad 13 distance 38mm 1.5in +2.3= 3.82in wire 4.00in  
 wire BB192 (104, 38) pad 14 distance 36mm 1.4in +2.3= 3.73in wire 3.75in  
 wire Y181 (103, 82) pad 15 distance 35mm 1.4in +2.3= 3.72in wire 3.75in  
 wire AA192 (112, 52) pad 16 distance 40mm 1.6in +2.3= 3.88in wire 4.00in  
 wire Z181 (112, 68) pad 17 distance 40mm 1.6in +2.3= 3.88in wire 4.00in  
 wire BB191 (121, 39) pad 18 distance 38mm 1.5in +2.3= 3.84in wire 4.00in  
 wire Y180 (119, 82) pad 19 distance 38mm 1.5in +2.3= 3.80in wire 4.00in  
 wire AA191 (128, 53) pad 20 distance 42mm 1.7in +2.3= 3.99in wire 4.00in  
 wire Z180 (128, 69) pad 21 distance 41mm 1.6in +2.3= 3.95in wire 4.00in  
 wire BB190 (137, 40) pad 22 distance 42mm 1.6in +2.3= 3.96in wire 4.00in  
 wire AA190 (144, 55) pad 23 distance 53mm 2.1in +2.3= 4.42in wire 4.50in

Longest wire AA190 at 112.4mm 4.42in Mean dist 98.4mm 3.88in

7 3.75-inch wires 12 4-inch wires 5 4.5-inch wires 0 5-inch wires 0 longer wires

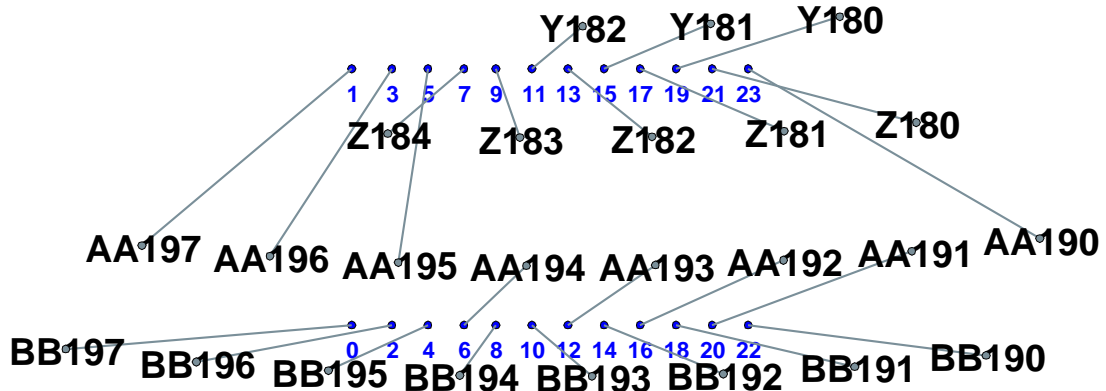

wire BB205 ( 22, 42) pad 0 distance 46mm 1.8in +2.3= 4.14in wire 4.50in  
 wire AA205 ( 32, 55) pad 1 distance 47mm 1.9in +2.3= 4.19in wire 4.50in  
 wire BB204 ( 38, 40) pad 2 distance 39mm 1.5in +2.3= 3.86in wire 4.00in  
 wire AA204 ( 48, 53) pad 3 distance 45mm 1.8in +2.3= 4.11in wire 4.50in  
 wire BB203 ( 55, 38) pad 4 distance 34mm 1.4in +2.3= 3.67in wire 3.75in  
 wire Z192 ( 55, 68) pad 5 distance 37mm 1.4in +2.3= 3.77in wire 4.00in  
 wire AA203 ( 64, 52) pad 6 distance 34mm 1.3in +2.3= 3.65in wire 3.75in  
 wire Z191 ( 72, 67) pad 7 distance 37mm 1.4in +2.3= 3.77in wire 4.00in  
 wire BB202 ( 71, 37) pad 8 distance 33mm 1.3in +2.3= 3.63in wire 3.75in  
 wire AA202 ( 80, 51) pad 9 distance 46mm 1.8in +2.3= 4.14in wire 4.50in  
 wire BB201 ( 88, 37) pad 10 distance 34mm 1.3in +2.3= 3.66in wire 3.75in  
 wire Y190 ( 80, 81) pad 11 distance 33mm 1.3in +2.3= 3.62in wire 3.75in  
 wire AA201 ( 96, 51) pad 12 distance 37mm 1.5in +2.3= 3.79in wire 4.00in  
 wire Z190 ( 88, 67) pad 13 distance 37mm 1.5in +2.3= 3.78in wire 4.00in  
 wire BB200 (104, 37) pad 14 distance 35mm 1.4in +2.3= 3.72in wire 3.75in  
 wire Y189 ( 96, 80) pad 15 distance 34mm 1.3in +2.3= 3.65in wire 3.75in  
 wire AA200 (112, 51) pad 16 distance 39mm 1.5in +2.3= 3.86in wire 4.00in  
 wire Z189 (105, 67) pad 17 distance 38mm 1.5in +2.3= 3.81in wire 4.00in  
 wire BB199 (120, 37) pad 18 distance 38mm 1.5in +2.3= 3.83in wire 4.00in  
 wire Z188 (121, 67) pad 19 distance 42mm 1.6in +2.3= 3.97in wire 4.00in  
 wire AA199 (128, 52) pad 20 distance 42mm 1.6in +2.3= 3.97in wire 4.00in  
 wire Z187 (138, 68) pad 21 distance 47mm 1.9in +2.3= 4.18in wire 4.50in  
 wire BB198 (137, 38) pad 22 distance 41mm 1.6in +2.3= 3.95in wire 4.00in  
 wire AA198 (144, 53) pad 23 distance 54mm 2.1in +2.3= 4.47in wire 4.50in

Longest wire AA198 at 113.4mm 4.47in Mean dist 98.6mm 3.88in

7 3.75-inch wires 11 4-inch wires 6 4.5-inch wires 0 5-inch wires 0 longer wires

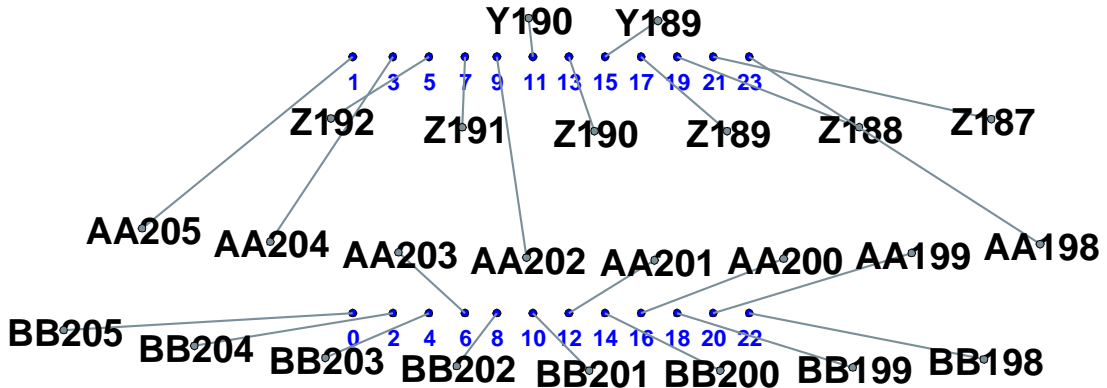

Board	3.75" wires	4" wires	4.25" wires	5" wires	Over 5"	Count	Longest	(")
A1	3	11	10	0	0	24	D53	4.38
A2	3	10	11	0	0	24	D12	4.26
A3	1	10	13	0	0	24	B15	4.46
A4	4	10	10	0	0	24	C26	4.34
A5	2	14	8	0	0	24	D26	4.28
A6	4	9	11	0	0	24	D39	4.26
A7	1	10	13	0	0	24	B36	4.47
A8	4	9	11	0	0	24	C53	4.33
B1	6	10	7	0	0	23	F64	4.42
B2	5	11	7	0	0	23	F5	4.26
B3	7	9	4	1	0	21	F19	4.55
B4	5	11	6	0	0	22	F20	4.34
B5	6	11	3	0	0	20	F27	4.29
B6	7	10	4	0	0	21	F39	4.14
B7	6	10	6	0	0	22	F42	4.42
B8	5	8	10	0	0	23	H60	4.29
B9	6	11	3	0	0	20	F56	4.25
C1	9	8	7	0	0	24	I10	4.50
C2	4	10	9	1	0	24	I18	4.50
C3	7	11	5	0	0	23	I20	4.29
C4	9	8	4	0	0	21	I27	4.42
C5	7	9	8	0	0	24	H31	4.37
C6	8	13	2	0	0	23	I44	4.47
C7	11	8	4	1	0	24	I53	4.52
C8	6	13	3	1	0	23	I69	4.52
C9	6	8	9	0	0	23	I70	4.47
C10	6	9	8	0	0	23	I86	4.50
C11	10	9	3	1	0	23	I1	4.50
D1	10	9	5	0	0	24	L104	4.36
D2	7	11	5	0	0	23	L5	4.26
D3	6	10	7	0	0	23	L13	4.37
D4	9	10	5	0	0	24	L26	4.29
D5	11	9	4	0	0	24	L34	4.29
D6	8	11	4	0	0	23	L35	4.26
D7	5	13	6	0	0	24	L43	4.36
D8	4	13	7	0	0	24	L57	4.49
D9	8	11	5	0	0	24	L64	4.30
D10	8	11	5	0	0	24	L65	4.26
D11	6	13	5	0	0	24	L73	4.26
D12	6	10	7	0	0	23	L81	4.36
D13	6	11	7	0	0	24	L95	4.30
D14	8	11	5	0	0	24	L103	4.50
E1	8	10	6	0	0	24	O2	4.22
E2	8	10	6	0	0	24	O9	4.38

E3	8	9	6	0	0	23	O17	4.38
E4	6	12	6	0	0	24	O25	4.40
E5	9	10	5	0	0	24	O33	4.21
E6	11	10	3	0	0	24	O41	4.41
E7	10	10	4	0	0	24	O49	4.38
E8	10	9	4	0	0	23	O58	4.18
E9	8	8	6	0	0	22	O65	4.41
E10	7	11	6	0	0	24	O73	4.35
E11	5	13	6	0	0	24	O81	4.40
E12	7	13	4	0	0	24	O89	4.43
E13	8	13	3	0	0	24	O97	4.37
E14	6	10	7	0	0	23	O105	4.38
E15	5	13	6	0	0	24	O116	4.21
E16	8	11	5	0	0	24	O128	4.46
E17	11	8	4	1	0	24	O1	4.51
F1	7	9	8	0	0	24	R4	4.49
F2	5	10	8	0	0	23	R12	4.49
F3	7	12	5	0	0	24	R16	4.14
F4	6	10	6	0	0	22	R20	4.23
F5	6	11	5	0	0	22	R29	4.20
F6	5	14	4	0	0	23	R39	4.11
F7	7	12	4	0	0	23	R43	4.23
F8	8	11	5	0	0	24	R51	4.32
F9	6	13	5	0	0	24	R65	4.49
F10	8	10	6	0	0	24	R72	4.30
F11	6	12	4	1	0	23	R73	4.56
F12	5	12	7	0	0	24	R82	4.19
F13	6	12	5	0	0	23	R94	4.13
F14	8	10	6	0	0	24	R98	4.19
F15	7	10	7	0	0	24	R107	4.20
F16	10	11	3	0	0	24	R118	4.29
F17	7	10	7	0	0	24	R127	4.49
F18	8	10	6	0	0	24	R128	4.23
F19	9	9	5	1	0	24	R135	4.56
G1	6	11	7	0	0	24	U166	4.46
G2	5	13	5	0	0	23	U4	4.45
G3	8	11	5	0	0	24	U12	4.48
G4	8	11	4	1	0	24	U28	4.53
G5	7	12	4	1	0	24	U36	4.52
G6	10	10	3	1	0	24	U44	4.52
G7	11	9	3	0	0	23	U51	4.21
G8	6	14	4	0	0	24	U52	4.47
G9	6	11	6	0	0	23	U60	4.46
G10	5	10	9	0	0	24	U68	4.47
G11	6	10	7	0	0	23	U76	4.46
G12	5	11	8	0	0	24	U84	4.46

G13	6	10	8	0	0	24	U92	4.44
G14	8	11	5	0	0	24	U100	4.45
G15	10	10	4	0	0	24	U108	4.45
G16	9	11	4	0	0	24	U116	4.47
G17	7	13	4	0	0	24	U131	4.19
G18	5	15	4	0	0	24	U132	4.45
G19	7	9	6	1	0	23	U148	4.51
G20	6	10	7	1	0	24	U149	4.55
G21	6	10	8	0	0	24	U159	4.35
H1	8	10	6	0	0	24	X1	4.25
H2	10	9	5	0	0	24	X16	4.49
H3	10	11	3	0	0	24	X17	4.24
H4	6	12	4	1	0	23	X31	4.51
H5	5	10	9	0	0	24	X32	4.32
H6	6	12	6	0	0	24	X46	4.49
H7	6	11	7	0	0	24	X53	4.28
H8	6	11	7	0	0	24	X54	4.34
H9	6	13	5	0	0	24	X68	4.29
H10	3	14	7	0	0	24	X76	4.49
H11	7	13	4	0	0	24	X83	4.15
H12	8	12	3	1	0	24	X84	4.57
H13	6	12	6	0	0	24	X97	4.23
H14	6	11	7	0	0	24	X101	4.21
H15	7	11	5	1	0	24	X107	4.56
H16	6	12	6	0	0	24	X120	4.13
H17	5	11	7	1	0	24	X122	4.58
H18	10	10	4	0	0	24	X130	4.33
H19	9	9	5	1	0	24	X137	4.57
H20	4	16	4	0	0	24	X152	4.49
H21	6	11	7	0	0	24	X153	4.33
H22	5	13	6	0	0	24	X166	4.29
H23	4	12	8	0	0	24	X167	4.35
H24	8	10	6	0	0	24	X175	4.35
I1	9	9	6	0	0	24	AA206	4.42
I2	8	11	5	0	0	24	AA5	4.42
I3	8	10	6	0	0	24	AA13	4.42
I4	6	12	6	0	0	24	AA21	4.43
I5	6	12	6	0	0	24	AA29	4.41
I6	6	10	8	0	0	24	AA37	4.44
I7	5	11	8	0	0	24	AA45	4.41
I8	6	10	8	0	0	24	AA53	4.44
I9	5	12	7	0	0	24	AA61	4.43
I10	6	11	6	1	0	24	AA77	4.52
I11	10	8	5	1	0	24	AA85	4.51
I12	8	10	5	1	0	24	AA93	4.52
I13	8	9	7	0	0	24	AA101	4.37



I14	9	9	6	0	0	24	AA102	4.41
I15	11	8	5	0	0	24	AA110	4.47
I16	11	8	5	0	0	24	AA118	4.40
I17	9	10	5	0	0	24	AA126	4.46
I18	7	11	6	0	0	24	AA134	4.37
I19	6	11	7	0	0	24	AA142	4.45
I20	6	12	6	0	0	24	AA150	4.35
I21	6	11	7	0	0	24	AA158	4.46
I22	6	10	8	0	0	24	AA166	4.34
I23	6	10	8	0	0	24	AA174	4.44
I24	6	11	7	0	0	24	AA182	4.44
I25	7	12	5	0	0	24	AA190	4.42
I26	7	11	6	0	0	24	AA198	4.47
	1018	1598	885	21	0	3522		